

Skins WallPaper



WHAT IS SKINS?

Skins is a new line of decorative wallpaper that expands Porcelanosa Group's offer in interior wall coverings.

It is an extraordinarily popular design option today and it is increasingly used by decorators and interior designers as it allows different styles to be captured with uniqueness and elegance.

It is washable, easy to install, and at an affordable price, features that contribute to it being an increasingly used decorative solution.

It can be applied in living rooms or bedrooms, on one wall, on two or on all of them, having the option of combining different models to create your own space with maximum originality and versatility. It can also be used for kitchens and bathrooms on walls where there is no direct contact with water.



FEATURES

There are three main types of decorative wallpaper:

Cellulose paper, conventional

Non-woven (NW)

Vinyl, a NW with an outer layer of vinyl

Skins uses non-woven (NW), so called because the fibers that compose it are not woven together and do not form threads, as a backing. Its benefits are mainly centered on three aspects:

- **Easier installation**, the wall is glued with Butech's Skins Fix adhesive to then proceed to apply the roll of wallpaper on the freshly glued substrate, therefore, there would not be need for a professional to glue the paper, as is the case with cellulose paper that requires double gluing, ie, backing and wall.
- **Washability**, unlike conventional paper, non-woven paper is washable, and stains can be cleaned with a cloth dampened with soap and water without deteriorating the product.
- **Greater resistance** to fading due to exposure to sunlight.



PRODUCTION STAGE

During the production process, the paper reel moves along several engraved cylinders that impregnate the ink into the paper, making the final finish.

The more complex and colorful the design, the more cylinders are involved in this process.

The images show the manufacture of the Skins Buckingham Coal design, in which you can see how the design of the paper becomes richer as the sequence of cylinders progresses.



MATCHING TYPES

The matching marks the distance in which the pattern is repeated along a roll of wallpaper. Therefore, you need to take this measurement into account for the installation of designs that feature both straight and skipped matchings.

During installation, so that the pattern is not mismatched between the strips, there is a waste equivalent to the size of the matching. Therefore, to calculate the number of rolls that will be needed, we must take into account these measurements.

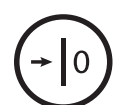

Random match

There is no need to follow an installation pattern, the drop always matches the previously installed roll.

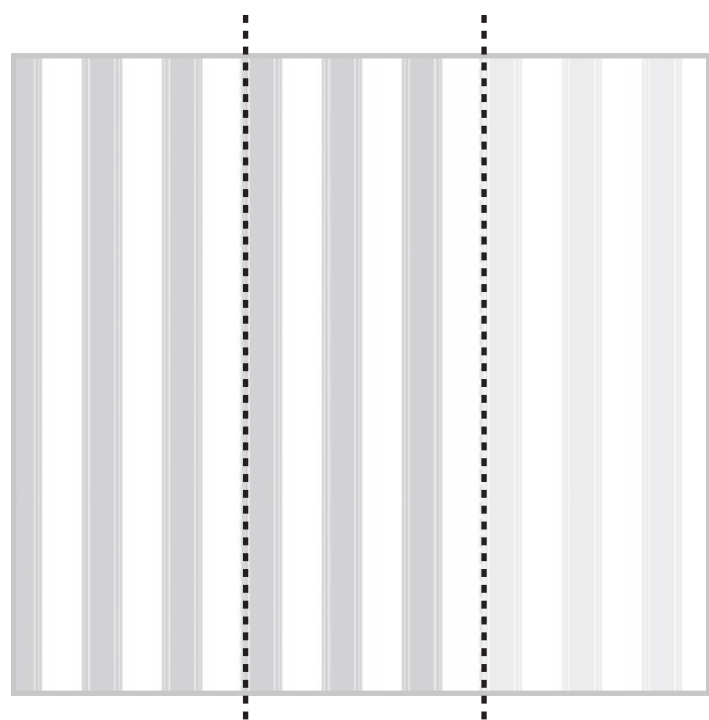

Straight match

The installation must be carried out in mirror mode, i.e. the end of the previous roll must always coincide with the beginning of the next roll to be installed.

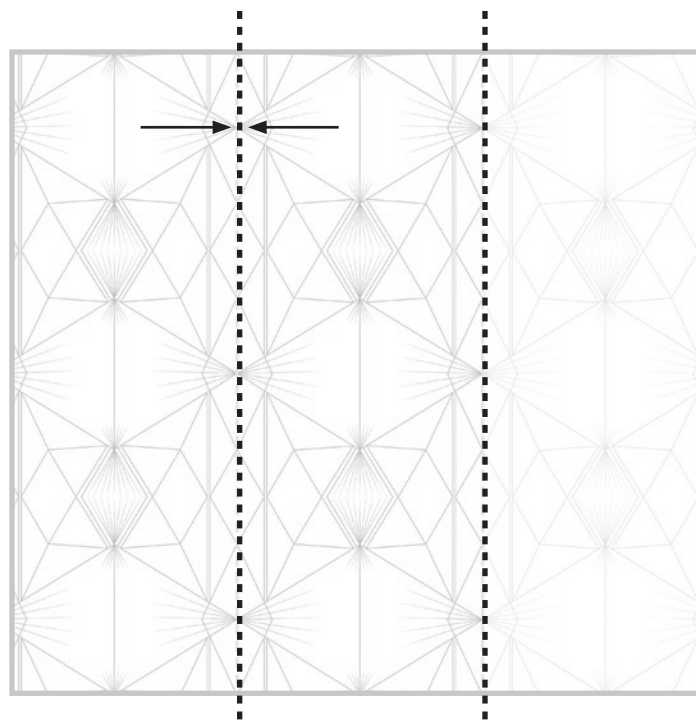

Drop match

The distance/drop in centimeters, indicated by the design, must be left during installation

E.g: $x = 26.5$ cm.

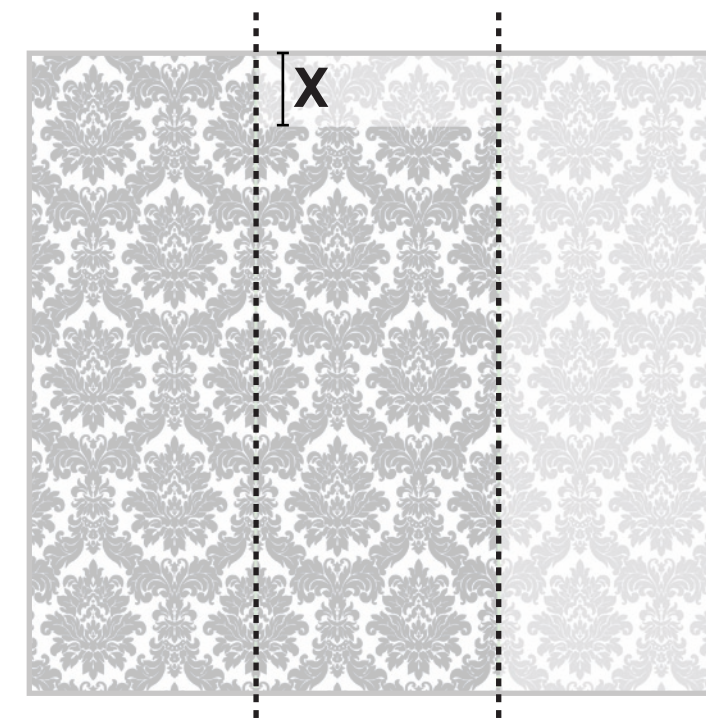

FORMAT

Skins is presented in **53 x 1005cm** format, which is the standard in Europe, also known as Euro-Roll.

In addition, the paper is classified according to its weight and density as follows:

- Light paper < 110g/m²
- Medium paper 110-140g/m²
- Heavy paper > 140g/m² (**SKINS = 147g/m²**)



INSTALLATION INSTRUCTIONS

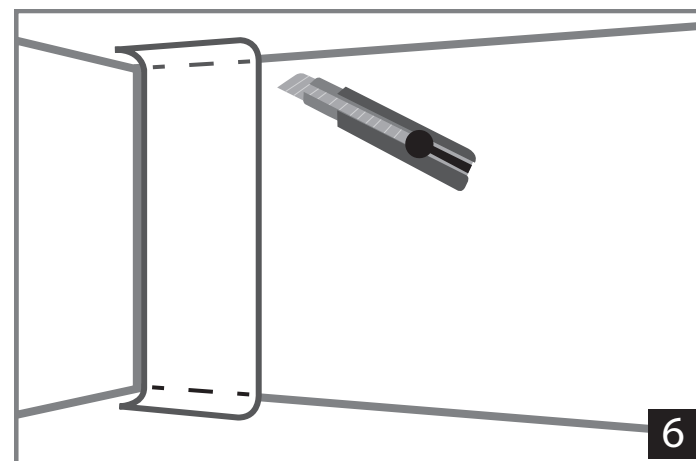
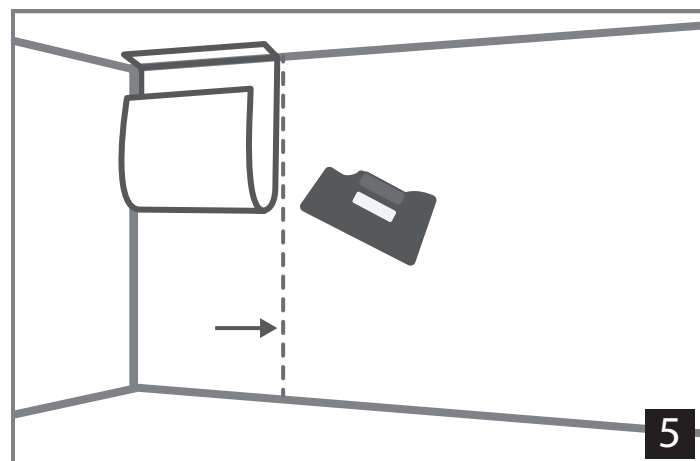
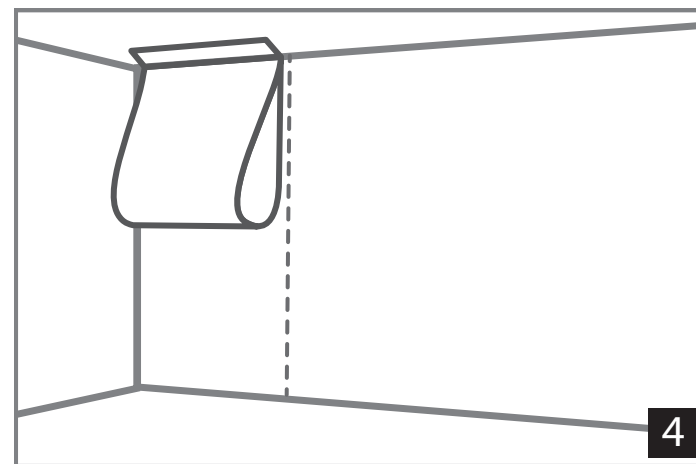
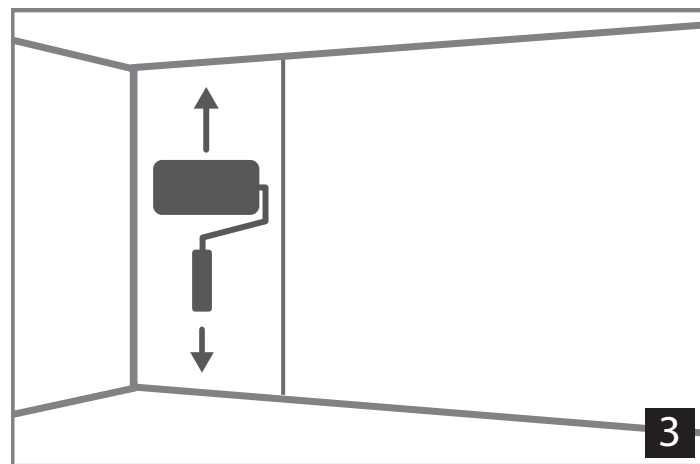
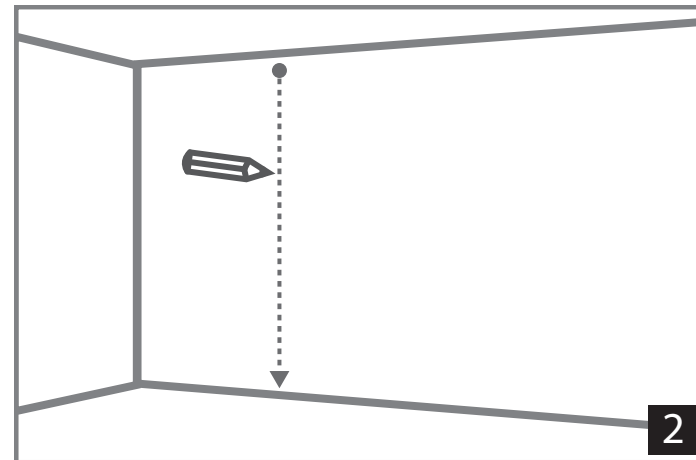
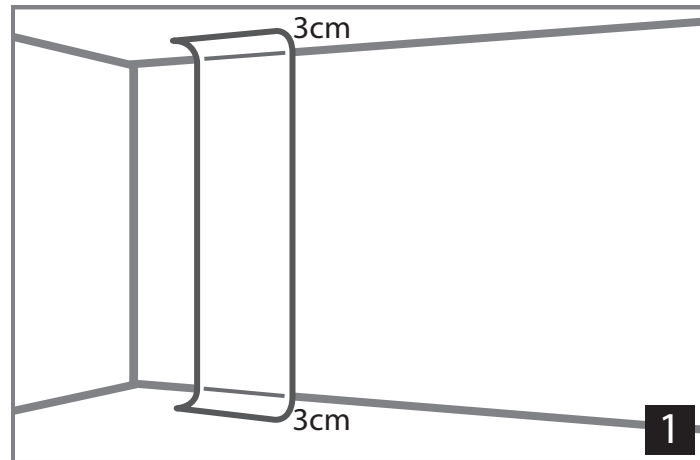

1. The wall should be dry, clean, smooth and of uniform light colour. Measure the height of the wall and then cut the roll of wallpaper, but adding 3 cm more up and 3 cm down.

2. Using a plumb bob, draw a line on the wall, which will be used as the reference line to indicate the right edge of the roll being the corner of the wall the reference for the opposite side.

3. Spread the paste on the wall with a paint roller. Exceed by 10 cm the width of the paper to be glued in order to ensure proper installation.

4. Start to paste the paper from the top edge, respecting the reference line already drawn with the plumb bob. Do not overlap strips.

5. Press slightly the top of the roll using a pasting brush or a rubber palette, following the reference line. Do the same to the lower half of the roll. To avoid bubbles, the pressure should be done from top to the bottom and from the centre to the sides.

6. Before it gets dried, wipe off glue residues with a damp cloth. Once dry, cut the remaining wallpaper at the top and at the bottom. We recommend to ventilate the place in order to let the wallpaper dry correctly.

MAINTENANCE AND CLEANING

SKINS stands out for its quality and resistance and does not get dirty easily with regular use. However, it requires a minimum of maintenance and cleaning.

For ordinary maintenance it is recommended to use a feather duster, or a soft dry cloth.

You can also use a sponge slightly dampened with water to gently rub the paper and then dry the surface with a cloth.

In case the wallpaper has been in contact with organic substances or chemical agents and becomes stained, please follow the steps below:

- Clean as soon as possible, first use a dry cloth to absorb the stain and avoid spreading it.
- Then proceed with a slightly damp sponge with water.
- Rub delicately.
- Finish by drying with a soft cloth.

Good prevention is essential when there is a risk of staining; avoid these situations as much as possible, as there are stains that can leave permanent marks after cleaning.

Never use aggressive products (bleach, ammonia, all-purpose cleaners...), or overly abrasive sponges or scouring pads, as they can permanently damage the paper.





A careful selection of art and decoration; a sophisticated mix of sensuality and casualness with which to fill each space with geometry, floral motifs, and color, lots of color.

Passion for extraordinariness

A wallpaper collection where the past is imposed creating an honest and attractive design, where functionality and meticulous quality move us every day.

SKINS WALLPAPER emerges from the latest trends in fashion. A collection, with character and young spirit, based on the era and style of cosmopolitan interiors.

We firmly believe in spaces with their own identity, in simplifying to get to the essence.

We want to give life to new spaces and enhance old places. We want to make encounters more charming and meetings different.

COLOR YOUR MOOD

The SKINS Wallpaper collection by L'Antic Colonial has 12 different ranges and a total of 48 models.

This wallpaper is manufactured on a non-woven (NWP) construction of 2 layers, and has a density of 147g/m² and a format of 53cm width by 10,05m length.



ICONOS



ROLL

Roll format.



GLUING THE WALL

The adhesive must be applied on the support to be decorated (gluing the wall).



EASY TO TEAR OFF

Allows for dry removal.



DROP MATCH

The distance/drop in centimeters, indicated by the design, must be left during installation (e.g. 17.7 cm, 26.5 cm, etc.).



RANDOM MATCH

There is no need to follow an installation pattern, the drop always matches the previously installed roll.



STRAIGHT MATCH

The rolls should be installed so that the pattern at end of the roll matches the pattern at the beginning of the next roll, creating a mirror effect.



NON WOVEN PAPER

Non woven paper.



STANDARD EUROPEAN WARRANTY (SEW)

The duration of the warranty is that provided by the European Standard Warranty.

ROYAL

ROYAL is an archive background that was born with the spirit of rescuing a modern classic design.

Its goal: to ease and inspire the design process for interior designers.

Designs for the contemporary world, as a result of the influence of cultures as different as classicism and avant-gardism.

This forces us to make a rereading of tradition and innovation, going through the Victorian influences of the British Crown.

Buckingham



Buckingham Aegean

53cm x 1005cm
20 7/8" x 395 5/8"
100307757
G-201



Buckingham Beige

53cm x 1005cm
20 7/8" x 395 5/8"
100307822
G-201



Buckingham Coal

53cm x 1005cm
20 7/8" x 395 5/8"
100307830
G-201



Buckingham Taupe

53cm x 1005cm
20 7/8" x 395 5/8"
100307831
G-201



Roll



Gluing the wall



Easy to tear off



Drop match
26,5 cm
10 3/8"



Non Woven Paper



Standard European
Warranty (SEW)

Windsor



Windsor Aegean
53cm x 1005cm
20 7/8" x 395 5/8"
100307843
G-201



Windsor Beige
53cm x 1005cm
20 7/8" x 395 5/8"
100307813
G-201



Windsor Coal
53cm x 1005cm
20 7/8" x 395 5/8"
100307826
G-201



Windsor Taupe
53cm x 1005cm
20 7/8" x 395 5/8"
100307835
G-201



Roll



Gluing the wall



Easy to tear off



Random match



Non Woven Paper



Standard European
Warranty (SEW)



Wall Covering Skins Windsor Coal Floor Covering Sherpa Brown

Sheffield



Sheffield Aegean

53cm x 1005cm
20 7/8" x 395 5/8"
100307841
G-201



Sheffield Beige

53cm x 1005cm
20 7/8" x 395 5/8"
100307812
G-201

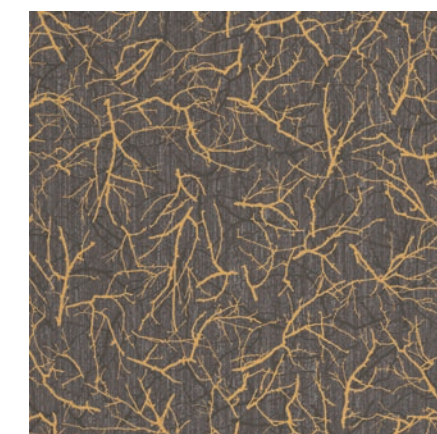

Sheffield Coal

53cm x 1005cm
20 7/8" x 395 5/8"
100307824
G-201



Sheffield Taupe

53cm x 1005cm
20 7/8" x 395 5/8"
100307842
G-201



Sheffield Pearl

53cm x 1005cm
20 7/8" x 395 5/8"
100307825
G-201



Roll



Gluing the wall



Easy to tear off



Drop match
26,5 cm
10 3/8"



Non Woven Paper



Standard European
Warranty (SEW)

Clarence

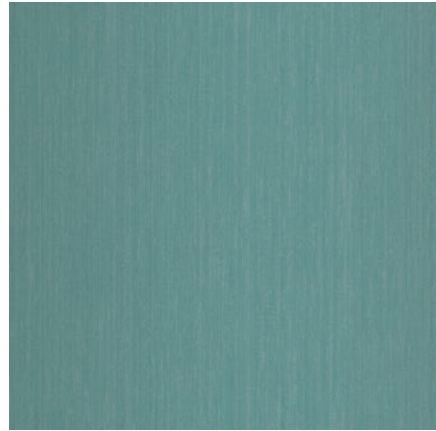

Clarence Aegean
53cm x 1005cm
20 7/8" x 395 5/8"
100307759
G-201



Clarence Beige
53cm x 1005cm
20 7/8" x 395 5/8"
100307840
G-201



Clarence Coal
53cm x 1005cm
20 7/8" x 395 5/8"
100307823
G-201



Clarence Taupe
53cm x 1005cm
20 7/8" x 395 5/8"
100307834
G-201



Roll



Gluing the wall



Easy to tear off



Random match



Non Woven Paper



Standard European
Warranty (SEW)



Wall Covering Skins Clarence Taupe Floor Covering Advance 1L Warm Oak



AMAZONIA

Our commitment to design and daring that distinguishes us so much.

Gorgeous finishes and bright colors that offer an endless repertoire to express one's own personality. Functional pieces that give life and turn your rooms into environments.

Perfect for young and fun interiors, supported by bright colors and overwhelming vegetation where everything is contrast.



Ficus Coal
53cm x 1005cm
20 7/8" x 395 5/8"
100307838
G-201



Ficus Forest
53cm x 1005cm
20 7/8" x 395 5/8"
100307829
G-201



Ficus Pearl
53cm x 1005cm
20 7/8" x 395 5/8"
100307839
G-201



Ficus Taupe
53cm x 1005cm
20 7/8" x 395 5/8"
100307816
G-201



Ficus Turquoise
53cm x 1005cm
20 7/8" x 395 5/8"
100307850
G-201



Roll



Gluing the wall



Easy to tear off



Drop match
26,5 cm
10 3/8"



Non Woven Paper



Standard European
Warranty (SEW)

Calatea



Calatea Beige
53cm x 1005cm
20 7/8" x 395 5/8"
100307758
G-201



Calatea Coal
53cm x 1005cm
20 7/8" x 395 5/8"
100307811
G-201



Calatea Rose
53cm x 1005cm
20 7/8" x 395 5/8"
100307832
G-201



Calatea Winter
53cm x 1005cm
20 7/8" x 395 5/8"
100307833
G-201



Roll



Gluing the wall



Easy to tear off



Straight match



Non Woven Paper



Standard European
Warranty (SEW)



Augusta



Wall Covering Skins Augusta Emerald



Augusta Agata

53cm x 1005cm
20 7/8" x 395 5/8"
100307788
G-201



Augusta Emerald

53cm x 1005cm
20 7/8" x 395 5/8"
100307789
G-201



Roll



Gluing the wall



Easy to tear off



Straight match



Non Woven Paper



Standard European
Warranty (SEW)



EMPORIA

A Collection born with the aim of reaching a wider audience, offering you a selection of very special design pieces.

A compilation of versatile wallpapers that invite you to escape from reality. Its graphic and geometric patterns, well thought-out colors and shadow effects create a unique spatial effect.

Simplicity and minimalist design taste show different textures, subtle patterns, and a harmoniously coordinated color palette.

Dreamland

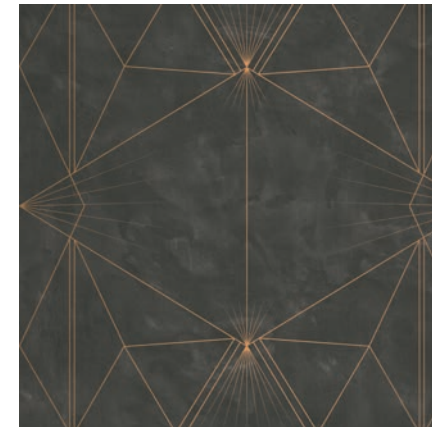

Dreamland Coal
53cm x 1005cm
20 7/8" x 395 5/8"
100307837
G-201

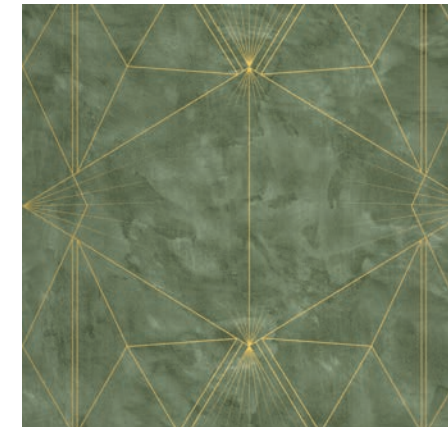

Dreamland Forest
53cm x 1005cm
20 7/8" x 395 5/8"
100307828
G-201

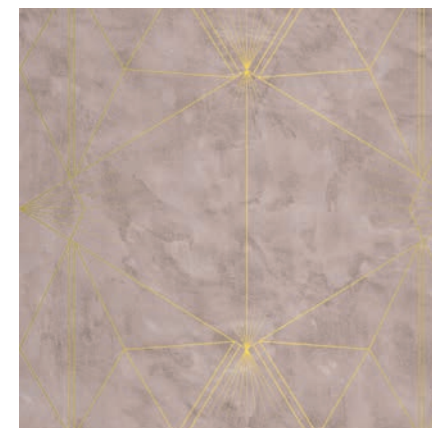

Dreamland Rose
53cm x 1005cm
20 7/8" x 395 5/8"
100307814
G-201



Dreamland Taupe
53cm x 1005cm
20 7/8" x 395 5/8"
100307815
G-201



Roll



Gluing the wall



Easy to tear off



Straight match



Non Woven Paper



Standard European
Warranty (SEW)

Mondrian



Mondrian Beige
53cm x 1005cm
20 7/8" x 395 5/8"
100307860
G-201



Mondrian Rose
53cm x 1005cm
20 7/8" x 395 5/8"
100307861
G-201



Mondrian Taupe
53cm x 1005cm
20 7/8" x 395 5/8"
100307845
G-201



Mondrian Turquoise
53cm x 1005cm
20 7/8" x 395 5/8"
100307851
G-201



Roll



Gluing the wall



Easy to tear off



Straight match



Non Woven Paper



Standard European
Warranty (SEW)





Tarian Aegean
53cm x 1005cm
20 7/8" x 395 5/8"
100307852
G-201



Tarian Beige
53cm x 1005cm
20 7/8" x 395 5/8"
100307853
G-201

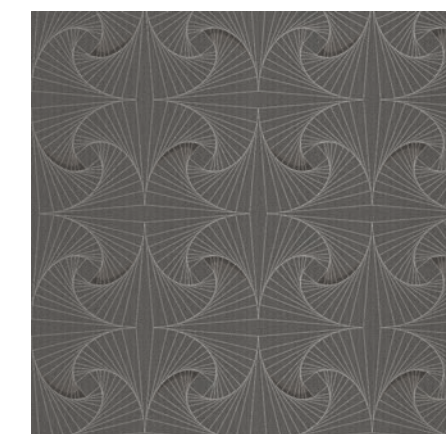

Tarian Coal
53cm x 1005cm
20 7/8" x 395 5/8"
100307870
G-201



Tarian Navy
53cm x 1005cm
20 7/8" x 395 5/8"
100307871
G-201



Tarian Taupe
53cm x 1005cm
20 7/8" x 395 5/8"
100307872
G-201



Roll



Gluing the wall



Easy to tear off



Straight match



Non Woven Paper



Standard European
Warranty (SEW)

Artenisa

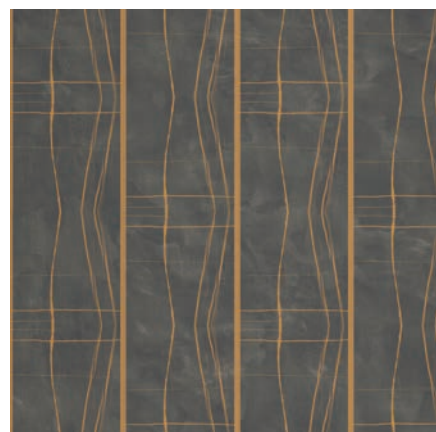

Artenisa Coal
53cm x 1005cm
20 7/8" x 395 5/8"
100307836
G-201



Artenisa Pearl
53cm x 1005cm
20 7/8" x 395 5/8"
100307844
G-201



Artenisa Taupe
53cm x 1005cm
20 7/8" x 395 5/8"
100307827
G-201



Roll



Gluing the wall



Easy to tear off



Straight match



Non Woven Paper



Standard European
Warranty (SEW)





Wall Covering Skins Ra Coal Floor Covering Linkfloor Rock Kayak

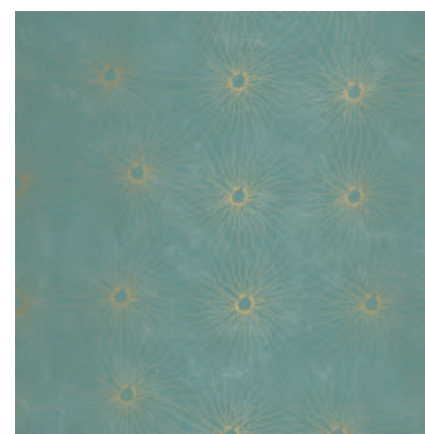

Ra Aegean
53cm x 1005cm
20 7/8" x 395 5/8"
100307817
G-201

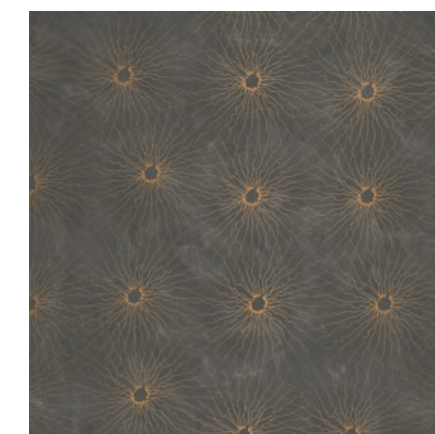

Ra Coal
53cm x 1005cm
20 7/8" x 395 5/8"
100307862
G-201

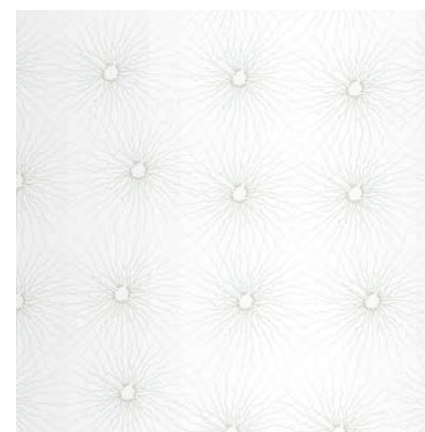

Ra Pearl
53cm x 1005cm
20 7/8" x 395 5/8"
100307818
G-201



Ra Taupe
53cm x 1005cm
20 7/8" x 395 5/8"
100307819
G-201



Roll



Gluing the wall



Easy to tear off



Straight match



Non Woven Paper



Standard European
Warranty (SEW)

l'ac
PORCELANOSA
Grupo



BY APPOINTMENT TO
H.R.H. THE PRINCE OF WALES
MANUFACTURER AND DISTRIBUTOR
OF CERAMIC TILES AND BUILDING PRODUCTS.
PORCELANOSA GROUP LIMITED

*Color your
mood*

anticcolonial.com