

# **baths** **baignoires** **2015**



# PORCELANOSA Grupo



BY APPOINTMENT TO  
H.R.H. THE PRINCE OF WALES  
MANUFACTURER AND DISTRIBUTOR  
OF CERAMIC TILES AND BUILDING PRODUCTS.  
PORCELANOSA GROUP LIMITED

**Prices excluding VAT**  
**Prix de vente publics hors taxe (H.T.)**

## freestanding



Victorian Single



Victorian Duo



Victorian Oval



Conic



Koan



Kubec



Novak

## bathtubs - baignoires



Soleil Round



Soleil Square



Soleil Oval



Soleil Quadra



Soleil Offset



Soleil Single

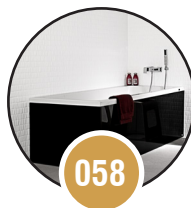

Minimal



Minimal XL



Minimal Duo



Minimal Offset



Minimal Oval



SP One



SP One XL



Ecolite



Acore

# INDEX - LÉGENDE

introduction - introduction



# VICTORIAN SINGLE

bathtubs - baignoires



bathtubs / baignoires VICTORIAN SINGLE

## COLOURS • COULEURS

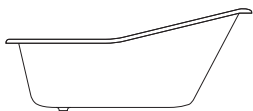

white  
blanc



black  
noir



navy Blue  
bleu marine

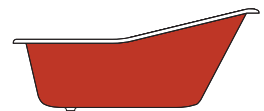

dark Red  
bordeaux

## ACCESSORIES • ACCESSOIRES

### BATH WASTE WITH PLUG AND CHAIN • VIDAGE



Gold  
Or



Chrome  
Chromé

### FEET • PIEDS

#### IMPERIAL



White  
Blanc



Chrome  
Chromé



Gold  
Or

#### CLUB



White  
Blanc



Chrome  
Chromé



Gold  
Or

# VICTORIAN SINGLE

bathtubs - baignoires

SIZES cm. • FORMATS cm.

170x76 • 79,5h

DRAWINGS mm. • PLANS mm.

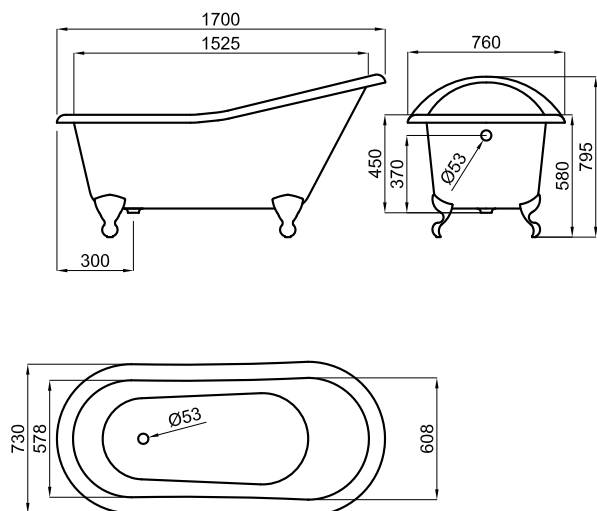

PRE-INSTALLING • PRE-INSTALLATION

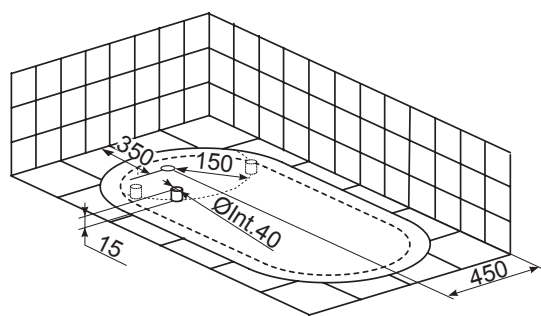

PACKAGING DETAILS • DONNÉES D'EXPÉDITION

DIMENSIONS DIMENSIONS		VOLUME VOLUME	NET WEIGHT POIDS NET	GROSS WEIGHT POIDS BRUT
L	187 cm	1,46 m <sup>3</sup>	144 Kg	200 Kg
W	84 cm			
H	93 cm			

# VICTORIAN SINGLE

bathtubs - baignoires

## VICTORIAN SINGLE 170x76 cm.

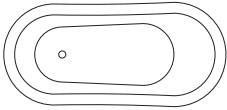

Water volume 205 l.  
Volume d'eau 205 l.

FINISH FINITION	FEET PIEDS	WASTE VIDAGE	SAP	KEA	€
White	Ornate	White	100083533	N710000250	5.406,00 €
		Yellow	100083535	N710000352	6.130,00 €
	Ornate	White	100083561	N710000427	5.137,00 €
		Yellow	100083563	N710000502	5.701,00 €
Red	Ornate	White	100083537	N710000313	5.651,00 €
		Yellow	100083541	N710000294	6.134,00 €
		White	100083539	N710000303	5.651,00 €
		Yellow	100083543	N710000369	6.375,00 €
	Ornate	White	100083565	N710000318	5.382,00 €
		Yellow	100083569	N710000373	5.866,00 €
		White	100083567	N710000308	5.382,00 €
		Yellow	100083571	N710000392	5.946,00 €
Blue	Ornate	White	100083545	N710000186	5.651,00 €
		Yellow	100083549	N710000301	6.134,00 €
		White	100083547	N710000320	5.651,00 €
		Yellow	100083551	N710000404	6.375,00 €
	Ornate	White	100083573	N710000433	5.382,00 €
		Yellow	100083577	N710000426	5.866,00 €
		White	100083575	N710000365	5.382,00 €
		Yellow	100083579	N710000569	5.946,00 €
Black	Ornate	White	100083553	N710000519	5.651,00 €
		Yellow	100083557	N710000491	6.134,00 €
		White	100083555	N710000439	5.651,00 €
		Yellow	100083559	N710000387	6.375,00 €
	Ornate	White	100083581	N710000396	5.382,00 €
		Yellow	100083585	N710000419	5.866,00 €
		White	100083583	N710000456	5.382,00 €
		Yellow	100083587	N710000336	5.946,00 €



Exposed bath waste with plug and chain, and floor flange included • Vidage et Siphon inclus



# VICTORIAN DUO

bathtubs - baignoires



bathtubs / baignoires VICTORIAN DUO

## COLOURS • COULEURS



white  
*blanc*



black  
*noir*



navy Blue  
*bleu marine*



dark Red  
*bordeaux*

## ACCESSORIES • ACCESSOIRES

### BATH WASTE WITH PLUG AND CHAIN • VIDAGE



Gold  
*Or*



Chrome  
*Chromé*

### FEET • PIEDS

#### LEON



White  
*Blanc*



Chrome  
*Chromé*



Gold  
*Or*

# VICTORIAN DUO

bathtubs - baignoires

## SIZES cm. • FORMATS cm.

180x77 • 79h

## DRAWINGS mm. • PLANS mm.

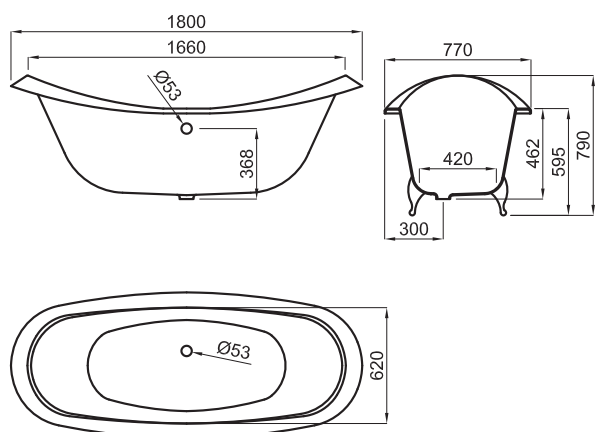

## PRE-INSTALLING • PRE-INSTALLATION

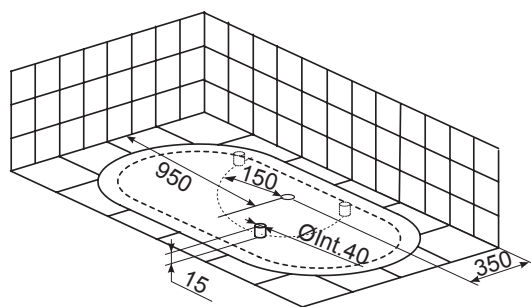

## PACKAGING DETAILS • DONNÉES D'EXPÉDITION

DIMENSIONS DIMENSIONS		VOLUME VOLUME	NET WEIGHT POIDS NET	GROSS WEIGHT POIDS BRUT
L	187 cm	1,46 m3	168 Kg	224 Kg
W	84 cm			
H	93 cm			

# VICTORIAN DUO

bathtubs - baignoires

## VICTORIAN DUO 180x77 cm.

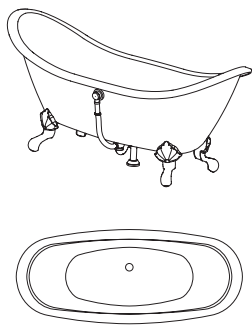

Water volume 195 l.  
Volume d'eau 195 l.

FINISH FINITION	FEET PIEDS	WASTE VIDAGE	SAP	KEA	€
White	Cast Iron	White	100083589	N710000374	5.779,00 €
		Gold	100083591	N710000378	6.427,00 €
Red	Cast Iron	White	100083593	N710000350	6.024,00 €
		White	100083597	N710000366	6.507,00 €
		White	100083595	N710000315	6.024,00 €
		Gold	100083599	N710000457	6.672,00 €
Blue	Cast Iron	White	100083601	N710000424	6.024,00 €
		White	100083605	N710000383	6.507,00 €
		White	100083603	N710000506	6.024,00 €
		Gold	100083607	N710000420	6.672,00 €
Black	Cast Iron	White	100083609	N710000431	6.024,00 €
		White	100083613	N710000482	6.507,00 €
		White	100083611	N710000361	6.024,00 €
		Gold	100083615	N710000462	6.672,00 €



Exposed bath waste with plug and chain, and floor flange included • *Vidage et Siphon inclus*

# VICTORIAN OVAL

bathtubs - baignoires



bathtubs / baignoires VICTORIAN OVAL

## COLOURS • COULEURS



white  
*blanc*



black  
*noir*



navy Blue  
*bleu marine*



dark Red  
*bordeaux*

## ACCESSORIES • ACCESSOIRES

### BATH WASTE WITH PLUG AND CHAIN • VIDAGE



Gold  
*Or*



Chrome  
*Chromé*

### FEET • PIEDS

#### IMPERIAL



Blanco  
*Branco*



Chrome  
*Chromé*



Gold  
*Or*

# VICTORIAN OVAL

bathtubs - baignoires

## SIZES cm. • FORMATS cm.

170x78 • 58,5h

## DRAWINGS mm. • PLANS mm.

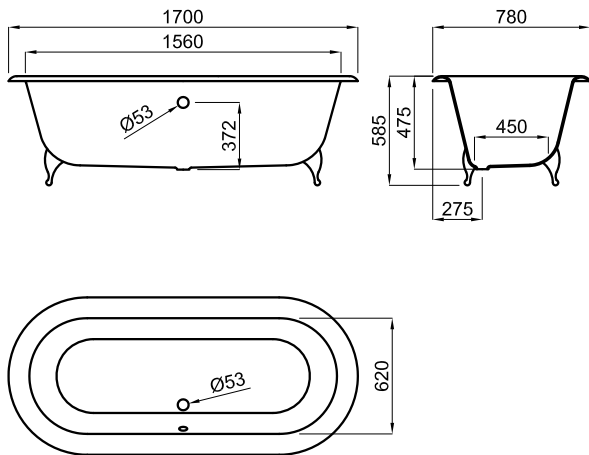

## PRE-INSTALLING • PRE-INSTALLATION

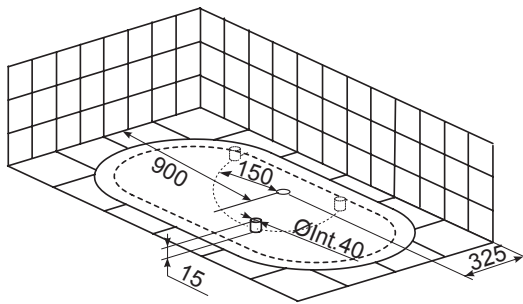

## PACKAGING DETAILS • DONNÉES D'EXPÉDITION

DIMENSIONS DIMENSIONS		VOLUME VOLUME	NET WEIGHT POIDS NET	GROSS WEIGHT POIDS BRUT
L	187 cm	1,46 m <sup>3</sup>	143 Kg	199 Kg
W	84 cm			
H	93 cm			

# VICTORIAN OVAL

bathtubs - baignoires

## VICTORIAN OVAL 170x78 cm.

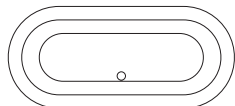
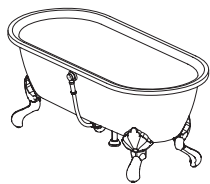

Water volume 190 l.  
Volume d'eau 190 l.

FINISH FINITION	FEET PIEDS	WASTE VIDAGE	SAP	KEA	€
White	Cast Iron	White	100083617	N710000326	4.506,00 €
		Gold	100083619	N710000343	5.230,00 €
Red	Cast Iron	White	100083621	N710000334	4.751,00 €
		White	100083625	N710000454	5.234,00 €
		White	100083623	N710000385	4.751,00 €
		Gold	100083627	N710000360	5.475,00 €
Blue	Cast Iron	White	100083629	N710000333	4.751,00 €
		White	100083633	N710000306	5.235,00 €
		White	100083631	N710000528	4.751,00 €
		Gold	100083635	N710000341	5.475,00 €
Black	Cast Iron	White	100083637	N710000421	4.751,00 €
		White	100083641	N710000348	5.234,00 €
		White	100083639	N710000417	4.751,00 €
		Gold	100083643	N710000463	5.475,00 €



Exposed bath waste with plug and chain, and floor flange included • *Vidage et Siphon inclus*



bathtubs / baignoires CONIC; brassware / robinetterie LOUNGE

## COLOURS • COULEURS



white  
blanc



Chrome  
Chromé

## ACCESSORIES • ACCESSOIRES



bath waste and overflow set  
*vidage automatique*

## SIZES cm. • FORMATS cm.

176 x 87 • 55h

## DRAWINGS mm. • PLANS mm.

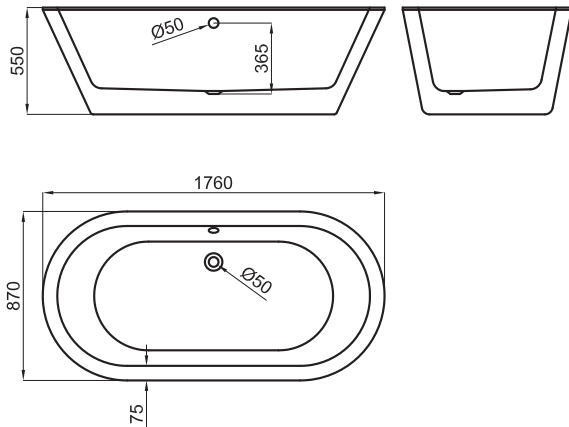

## PRE-INSTALLING • PRE-INSTALLATION

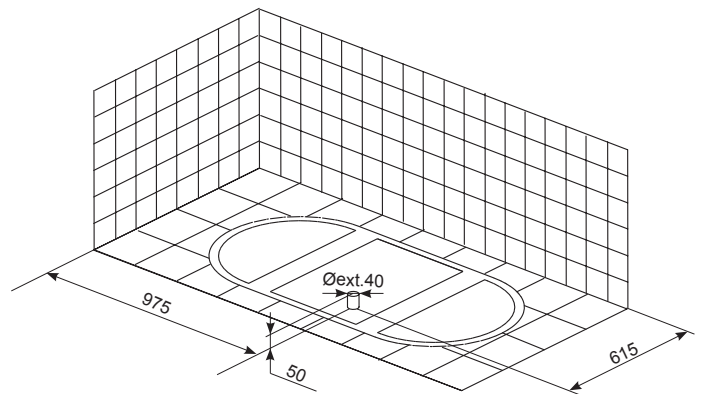

## PACKAGING DETAILS • DONNÉES D'EXPÉDITION

DIMENSIONS DIMENSIONS		VOLUME VOLUME	NET WEIGHT POIDS NET	GROSS WEIGHT POIDS BRUT
L	181 cm	1,16 m³	47 Kg	67 Kg
W	92 cm			
H	70 cm			

## CONIC 176 x 87 cm.

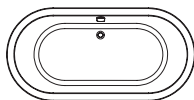
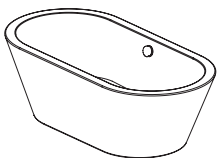

Water volume 231 l.  
Volume d'eau 231 l.

	SAP	KEA	€
CENTER	100080457	N710000262	3.208,00 €

Bath waste and overflow set included. Syphon not included  
Vidage automatique inclus. Siphon non inclus

## ACCESSORIES • ACCESSOIRES

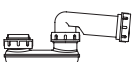

DESCRIPTION DESCRIPTION	SAP	KEA	€
Bath trap NEXT D40 • Siphon vidage pour baignoire NEXT D40	100158208	N790001657	11,00 €





bathtubs / baignoires KOAN

## COLOURS • COULEURS

---



white  
blanc



Chrome  
Chromé

## ACCESSORIES • ACCESSOIRES

---



bath waste and overflow set  
*vidage automatique*

**SIZES cm. • FORMATS cm.**

165 x 78 • 68h  
191 x 97 • 72h

**DRAWINGS mm. • PLANS mm.**

KOAN 1650 x 780

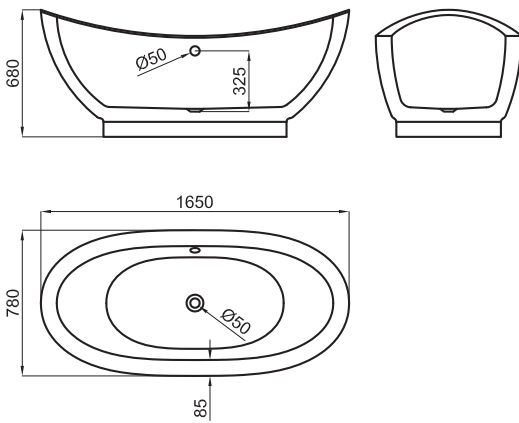

KOAN 1910 x 970

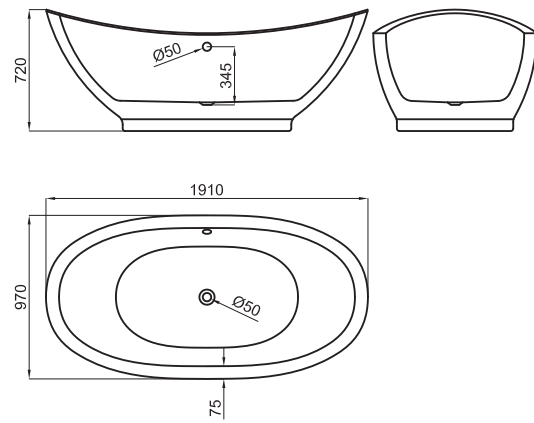

**PRE-INSTALLING • PRE-INSTALLATION**

KOAN 1650 x 780

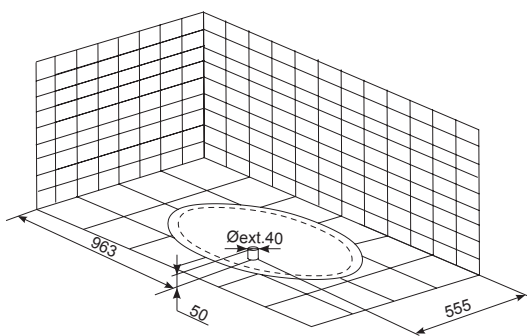

KOAN 1910 x 970

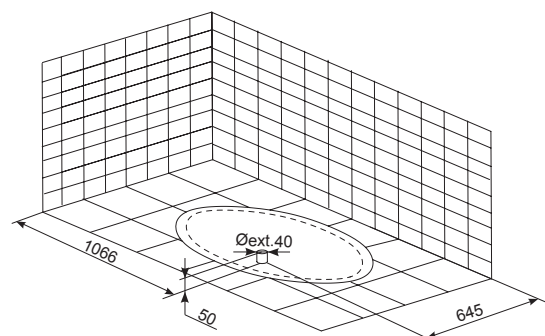

**PACKAGING DETAILS • DONNÉES D'EXPÉDITION**

	DIMENSIONS <i>DIMENSIONS</i>		VOLUME <i>VOLUME</i>	NET WEIGHT <i>POIDS NET</i>	GROSS WEIGHT <i>POIDS BRUT</i>
1650 x 780	L	170 cm	1,17 m <sup>3</sup>	39 Kg	59 Kg
	W	83 cm			
	H	83 cm			
1910 x 970	L	196 cm	1,74 m <sup>3</sup>	50 Kg	73 Kg
	W	102 cm			
	H	87 cm			

**KOAN 165 x 78 cm. - 191 x 97 cm.**

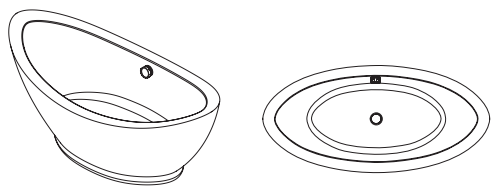

165x78  
Water volume 120 l.  
*Volume d'eau 120 l.*

191x97  
Water volume 195 l.  
*Volume d'eau 195 l.*

	DIMENSIONS <i>DIMENSIONS</i>	SAP	KEA	€
CENTER	165x78	100080463	N710000236	4.580,00 €
	191x97	100083261	N710000329	4.822,00 €

Bath waste and overflow set included. Syphon not included  
*Vidage automatique inclus. Siphon non inclus*

**ACCESSORIES • ACCESSOIRES**

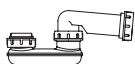

DESCRIPTION <i>DESCRIPTION</i>	SAP	KEA	€
Bath trap NEXT D40 • <i>Siphon vidage pour baignoire NEXT D40</i>	100158208	N790001657	11,00 €



bathtubs / baignoires KUBEC

## COLOURS • COULEURS

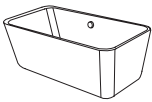

white  
blanc



Chrome  
Chromé

## ACCESSORIES • ACCESSOIRES



bath waste and overflow set  
*vidage automatique*

## SIZES cm. • FORMATS cm.

175 x 78 • 61h

## DRAWINGS mm. • PLANS mm.

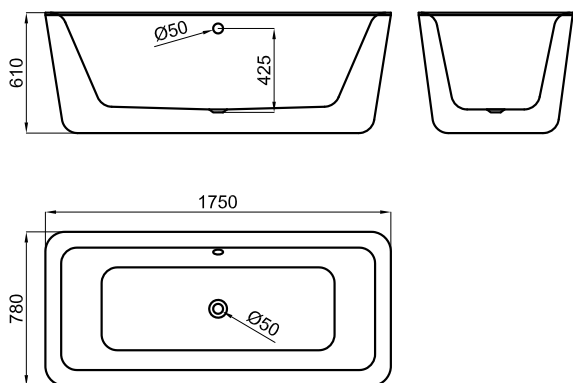

## PRE-INSTALLING • PRE-INSTALLATION

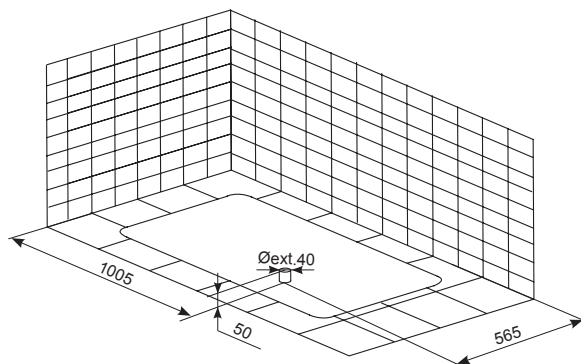

## PACKAGING DETAILS • DONNÉES D'EXPÉDITION

DIMENSIONS DIMENSIONS		VOLUME VOLUME	NET WEIGHT POIDS NET	GROSS WEIGHT POIDS BRUT
L	181 cm	1,13 m³	48 Kg	68 Kg
W	82 cm			
H	76 cm			

## KUBEC 175 x 78 cm.

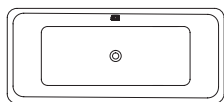
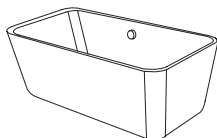

Water volume 262 l.  
Volume d'eau 262 l.

	SAP	KEA	€
CENTER	100142849	N710001151	3.939,00 €

Bath waste and overflow set included. Syphon not included  
Vidage automatique inclus. Siphon non inclus

## ACCESSORIES • ACCESSOIRES



DESCRIPTION DESCRIPTION	SAP	KEA	€
Bath trap NEXT D40 • Siphon vidage pour baignoire NEXT D40	100158208	N790001657	11,00 €



bathtubs / baignoires NOVAK

## COLOURS • COULEURS



white  
blanc



Chrome  
Chromé

## ACCESSORIES • ACCESSOIRES



bath waste and overflow set  
*vidage automatique*

## SIZES cm. • FORMATS cm.

180 x 84 • 51h

## DRAWINGS mm. • PLANS mm.

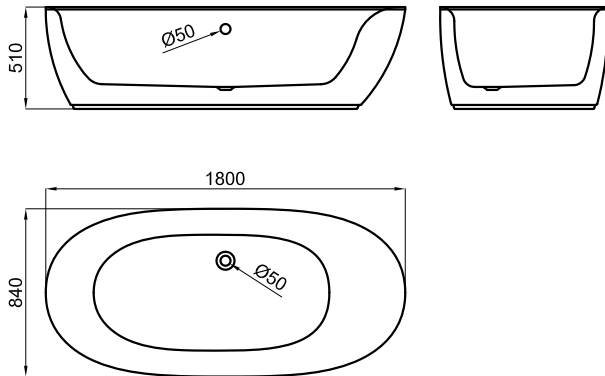

## PRE-INSTALLING • PRE-INSTALLATION

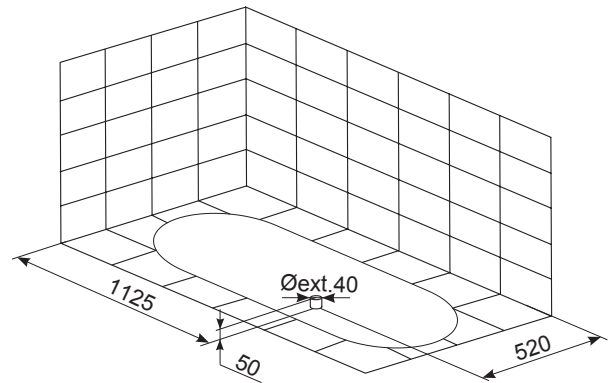

## PACKAGING DETAILS • DONNÉES D'EXPÉDITION

DIMENSIONS DIMENSIONS		VOLUME VOLUME	NET WEIGHT POIDS NET	GROSS WEIGHT POIDS BRUT
L	185 cm	1,14 m <sup>3</sup>	39 Kg	60 Kg
W	89 cm			
H	69 cm			

## NOVAK 180 x 84 cm

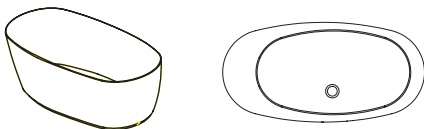

Water volume 182 l.  
Volume d'eau 182 l.

	SAP	KEA	€
CENTER	100146568	N710001057	4.085,00 €

Bath waste and overflow set included. Syphon not included  
Vidage automatique inclus. Siphon non inclus

## ACCESSORIES • ACCESSOIRES



DESCRIPTION DESCRIPTION	SAP	KEA	€
Bath trap NEXT D40 • Siphon vidage pour baignoire NEXT D40	100158208	N790001657	11,00 €

# BATHS - BAIGNOIRES

introduction - introduction

## BENEFITS OF WHIRL TUBS - BÉNÉFIQUE DU HYDROMASSAGE

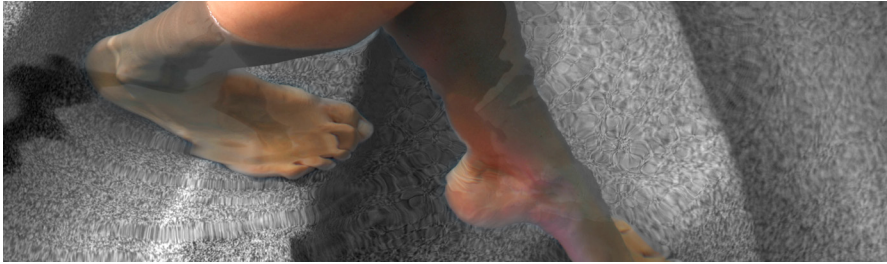

A whirl tub is much more than a luxurious accessory for your home. Bathing in whirl bath tubs for a period of time has a number of benefits, both physical and mental.

*L'hydro massage est recommandé par beaucoup de professionnels pour combattre la maladie de notre société : le stress. Les médecins le recommandaient de manière thérapeutique ; dans l'actualité, il s'agit d'une recommandation préventive. L'hydro massage peut également combattre l'anxiété et l'insomnie puisque cela fait du bien non seulement à notre corps mais aussi à notre esprit.*



### Some benefits:

- Stress relieving: mental stress can manifest itself as physical pain. By relieving this stress in a whirl tub, people can reduce their stiff necks, back aches and muscle tension. It is a rejuvenation for the body and mind.
- Sleep improving: regular users report having longer lasting and better quality sleep when they take a bath before bedtime. The hot water and jets relax the muscles and unwind the mind, getting the person's entire body and soul ready for sleep.
- Soothes Muscles and Joints. The hot water and surging jets improve blood flow and relieves the knots and cramps of over-exerted muscles and joints.
- Blood Pressure. A whirl tub can lower blood pressure on two fronts. First, by making the person take time to relax, and thus reduce their stress and blood pressure. Secondly, the hot water increases blood flow.

A soak in a whirl bath tub can leave you feeling invigorated and improve your health.

*Les bains à bulles exercent des effets très positifs sur la circulation sanguine. La pression active la circulation sanguine et aide l'activité cardiaque. Cela permet aussi de relaxer les muscles et d'éliminer les toxines en ouvrant les pores. Ce type de bains permet de soulager les ulcères d'estomac et de récupérer de fractures et lésions musculaires.*

## RECOMMENDATIONS FOR BATHING - RECOMMANDATIONS DE COMMENT UTILISER LE BAIN



1

Enjoy the pleasant sensations of air jets with the massaging power of whirl jets

*Submergez votre corps autant que vous pouvez et relaxez vous.*

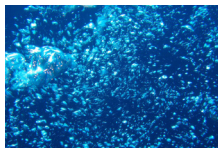

2

Select carefully the intensity and position of the jets to your personal preferences.

*Sélectionner l'intensité de pression et la position des buses.*



3

Relax for soaking and unwind your mind.

*Une musique relaxante dans votre bain vous permettra de rêver et de vous évader totalement.*



4

Do not use the whirl tub while under the influence of drugs or alcohol.

*Si vous êtes très fatigué ou sous l'effet de l'alcool ou de médicaments, ne prenez pas votre bain afin d'éviter de vous évanouir.*



5

Do not use the whirl tub when you feel sleepy.

*Si vous avez une sensation de sommeil, sortez rapidement de votre bain.*



6

Do not use massaging jets during pregnancy.

*Si vous êtes enceinte, ne pas activer les buses d'hydro massage non recommandées.*



7

The product is designed to be used only by adults. Children, elderly or infirm individuals should only use the whirl tub under supervision.

*Attention aux enfants ; toujours les contrôler s'ils sont proche ou dans la baignoire.*



8

Make sure you do not activate the hydro system until the tub is filled with sufficient water.

*Ne pas activer le système d'hydro massage avant d'avoir un niveau minimum d'eau.*



9

The recommended bathing time is 15 to 20 minutes.

*Ne pas rester des heures dans le bain. Vous pouvez avoir une baisse de tension. La durée recommandée est de 15-20 minutes. Faites attention au fait que, plus l'eau est froide, plus le bain doit être de courte durée.*



# BATHS - BAIGNOIRES

introduction - introduction

## S0 EQUIPMENT • EQUIPEMENT S0

The S0 version contains a powerful pump for a correct distribution of water into the massage jets of the whirl tub. It is also equipped with a safety system that prevents the pump to work when the aspiration window is blocked. If no water is detected the pump interrupts, to prevent it from working without water and get damaged. Moreover an internal water distribution system avoids water retention in the pipes. Additionally, the pump includes an anti-vibration system to make it more silent and improve your bathing experience. A stainless steel backlit keypad control for operating is positioned on the tub ledge.

Les baignoires avec système S0 sont équipées d'une pompe appropriée pour la distribution de l'eau dans les jets d'hydro massage que ces baignoires possèdent.

Le système de distribution interne d'eau évite la rétention d'eau dans la tuyauterie.

Tous les jets sont orientables, chromés et ont un système manuel d'ouverture et de fermeture. Si le flux d'eau n'est pas détecté, la pompe arrête de fonctionner, évitant ainsi de travailler sans eau.

Un système de sécurité permet d'éviter que la pompe ne fonctionne lorsque la crépine d'aspiration est bloquée afin d'éviter d'aspirer d'autres éléments dans celle-ci.

La pompe est silencieuse et possède des supports anti vibration, permettant ainsi un massage encore plus confortable.

Contrôle par clavier électronique rétro éclairé.

### S0

Water massage  
Hydromassage



6-10 hydromassage jets <sup>(1)</sup>  
6-10 jets hydromassage



Pump 800W  
Pompe 800W



<sup>(1)</sup> Check on version • Consultez la version



## SX EQUIPMENT • EQUIPEMENT SX

The SX systems, depending on the version, include a powerful pump for water massage jets and a blower for the ultra-slim air blowers that are located at the bottom part of the tub. An air tub system works on the introduction of air into the water to create bubbles and the sensation of an effervescent light massage. The water massage jets also present an ultra-slim format for an approved appearance, with an elegant chrome-white finish, and more comfortable bathing experience.

An incorporated electronic device will detect the water level and will block the system if the minimum level is not reached, even when you activate the start button. The pump is extra silent and includes an anti-vibration system. A stainless steel backlit keypad control for operating is positioned on the tub ledge. Depending on your SX version it will activate hydro massage jets, air jets, chromo therapy and/or automatic disinfection.

Les baignoires avec système SX sont équipées d'une forte pompe appropriée pour chacune des dimensions, garantissant un hydro massage correct.

Les nouveaux jets latéraux ultra plats sont parfaitement intégrés dans les parois des baignoires sans aucune protubérance. Cela permet un confort supplémentaire mais également une élégance avec ses finitions chromées et blanches.

Les buses d'air au sol de la baignoire sont également extra plats permettant ainsi un meilleur confort. La pompe ainsi que les jets incluent un système anti vibration qui permet de réduire le niveau sonore.

Une cellule électronique permet de détecter le niveau d'eau ; ainsi, si le bouton de mise en marche est actionné sans que le niveau minimum d'eau soit atteint, l'hydro massage ne fonctionnera pas.

Les claviers en acier inoxydable ultra brillant et rétro éclairés vous permettent de choisir entre les différentes fonctions d'hydro massage, la chromothérapie et le système de désinfection automatique.

### SX1

Air massage  
Massage air



8-22 air jets <sup>(1)</sup>  
8-22 jets air (1)



Blower 400W  
Blower 400W



Bath waste with hidden overflow <sup>(2)</sup>  
Vidage avec trop-plein caché (2)



### SX2

Water massage  
Hydromassage



8-15 hydromassage jets <sup>(1)</sup>  
8-15 jets hydromassage (1)



Pump 800W  
Pompe 800W



Bath waste with hidden overflow <sup>(2)</sup>  
Vidage avec trop-plein caché (2)



<sup>(1)</sup> Check on version • Consultez la version

<sup>(2)</sup> SOLEIL ROUND, SOLEIL SQUARE, SOLEIL OFFSET & SOLEIL OVAL

## SX EQUIPMENT • EQUIPEMENT SX

### SX3



Water massage  
*Hydromassage*



8-15 hydromassage jets <sup>(1)</sup>  
*8-15 jets hydromassage (1)*



Pump 800W  
*Pompe 800W*



Air massage  
*Massage air*



8-22 air jets <sup>(1)</sup>  
*8-22 jets air (1)*



Blower 400W  
*Blower 400W*



Bath waste with hidden overflow <sup>(2)</sup>  
*Vidage avec trop-plein caché (2)*



### SX4



Water massage  
*Hydromassage*



8-15 hydromassage jets <sup>(1)</sup>  
*8-15 jets hydromassage (1)*



Pump 800W  
*Pompe 800W*



Air massage  
*Massage air*



8-22 air jets <sup>(1)</sup>  
*8-22 jets air (1)*



Blower 400W  
*Blower 400W*



8-15 chromotherapy LED coloured light <sup>(1)</sup>  
*8-15 spots chromothérapie (1)*



Disinfection  
*Désinfection*



Bath waste with hidden overflow <sup>(2)</sup>  
*Vidage avec trop-plein caché (2)*



### SX5

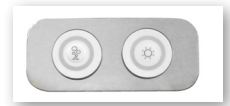

Air massage  
*Massage air*



Blower 400W  
*Blower 400W*



8-22 air jets <sup>(1)</sup>  
*8-22 jets air (1)*



8-15 chromotherapy LED coloured light <sup>(1)</sup>  
*8-15 spots chromothérapie (1)*



Bath waste with hidden overflow <sup>(2)</sup>  
*Vidage avec trop-plein caché (2)*



<sup>(1)</sup> Check on version • Consultez la version

<sup>(2)</sup> SOLEIL ROUND, SOLEIL SQUARE, SOLEIL OFFSET & SOLEIL OVAL

# BATHS - BAIGNOIRES

introduction - introduction

## ELECTRONICS OPTIONS • OPTIONS ÉLECTRONIQUES

### BASIC

Acrylic bath  
Baignoire acrylique

### S0



Backlight keypad control  
Water massage  
6-10 hydromassage jets  
Pump 800W  
Clavier contrôle rétroéclairé  
Hydromassage  
6-10 jets hydromassage  
Pompe 800W

### BASIC WITH LEGS BASIC AVEC PIEDS

Acrylic bath with legs  
Baignoire acrylique avec pieds

### SX1



Backlight keypad control  
Air massage  
8-22 air jets extra-slim  
Hidden overflow waste  
Blower 400W  
Clavier contrôle rétroéclairé  
Massage air  
8-22 jets air extraplat  
Vidage avec trop plein caché  
Blower 400W

### CENTER

Free-standing acrylic bath  
Baignoire acrylique pour free standing

### SX2

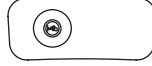

Backlight keypad control  
Water massage  
8-15 hydromassage jets extra-slim  
Pump 800W  
Hidden overflow waste  
Blower 400W  
Clavier contrôle rétroéclairé  
Hydromassage  
8-15 jets hydromassage extraplat  
Pompe 800W  
Vidage avec trop plein caché

### BATH WITH FRAME CHASSIS SANS HYDROMASSAGE

Acrylic bath with metallic galvanised frame  
Baignoire acrylique avec châssis métallique galvanisé

### SX3



Backlight keypad control  
Water massage  
8-15 hydromassage jets extra-slim  
Pump 800W  
Air massage  
8-22 air jets extra-slim  
Blower 400W  
Hidden overflow waste  
Clavier contrôle rétroéclairé  
Hydromassage  
8-15 jets hydromassage extraplat  
Pompe 800W  
Massage air  
8-22 jets air extraplat  
Blower 400W  
Vidage avec trop plein caché

### SX4



Backlight keypad control  
Water massage  
8-15 hydromassage jets extra-slim  
Pump 800W  
Air massage  
8-22 air jets extra-slim  
Blower 400W  
Hidden overflow waste  
8-15 chromotherapy LED coloured light extra-slim  
Disinfection  
Not available in built-in version  
Clavier contrôle rétroéclairé  
Hydromassage  
8-15 jets hydromassage extraplat  
Pompe 800W  
Hydromassage air  
8-22 jets air extraplat  
Blower 400W  
Vidage avec trop plein caché  
8-15 lumières chromothérapie extraplat  
Désinfection  
Version encastré non disponible

### SX5



Backlight keypad control  
Air massage  
8-15 air jets extra-slim  
Blower 400W  
Hidden overflow waste  
8-15 chromotherapy LED coloured light extra-slim  
Not available in built-in version  
Clavier contrôle rétroéclairé  
Hydromassage air  
8-22 jets air extraplat  
Blower 400W  
Vidage avec trop plein caché  
8-15 lumières chromothérapie extraplat  
Version encastré non disponible

# SOLEIL ROUND

bathtubs - baignoires



bathtubs / baignoires SOLEIL ROUND

## COLOURS • COULEURS

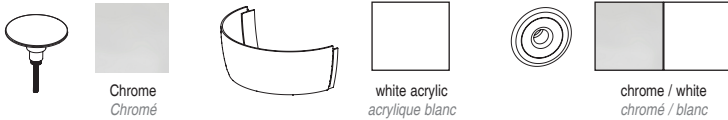

## ACCESSORIES • ACCESSOIRES

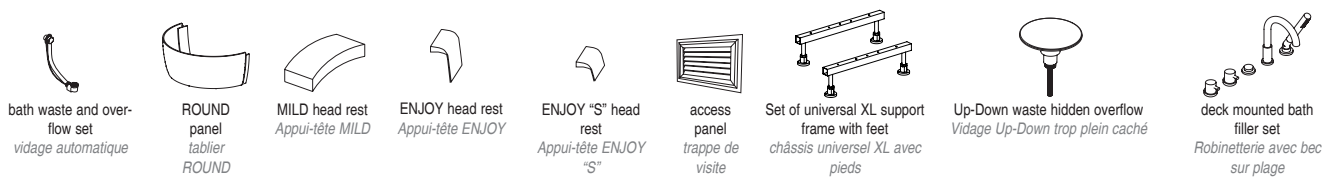

## SIZES cm. • FORMATS cm.

Ø170 • 68h

# SOLEIL ROUND

bathtubs - baignoires

## EQUIPMENT • EQUIPEMENT

		S0	SX1	SX2	SX3	SX4	SX5
JETS		10	-	12	12	12	-
BLOWERS		-	12	-	12	12	12
CHROMOTHERAPY CHROMOTHERAPIE		-	-	-	-	12	12
DISINFECTION DÉSINFECTION		-	-	-	-	✓	-

See features on page 22-25.

Consultez caractéristiques en page 22-25.

## DRAWINGS mm. • PLANS mm.

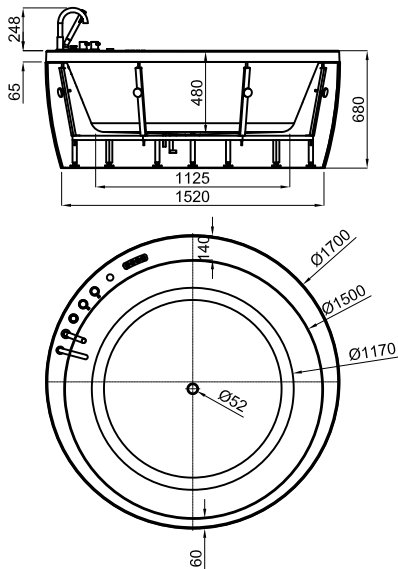

## PRE-INSTALLING • PRE-INSTALLATION

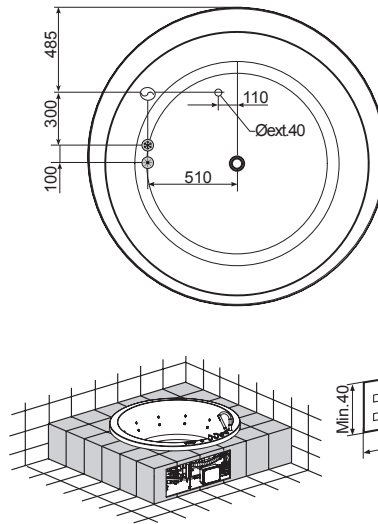

	Hot water connections Prise d'eau chaude
	Cold water connections Prise d'eau froide
	Waste Vidage
	Electrical connections Câblage électrique

## PACKAGING DETAILS • DONNÉES D'EXPÉDITION

	DIMENSIONS DIMENSIONS		VOLUME VOLUME	NET WEIGHT / PIECE POIDS NET / PIÈCE	GROSS WEIGHT / PALLET POIDS BRUT / PALETTE	PIECES / PALLET PIÈCES / PALETTE
BASIC	L	180 cm	4,54 m <sup>3</sup>	53 Kg	550 Kg	10
	W	180 cm				
	H	140 cm				
BATH WITH FRAME CHASSIS SANS HYDROMASSAGE	L	180 cm	3,08 m <sup>3</sup>	87 Kg	138,5 Kg	1
	W	180 cm				
	H	95 cm				
S0	L	180 cm	3,08 m <sup>3</sup>	104,7 Kg	156,2 Kg	1
	W	180 cm				
	H	95 cm				
SX1	L	180 cm	3,08 m <sup>3</sup>	98,5 Kg	150 Kg	1
	W	180 cm				
	H	95 cm				
SX2	L	180 cm	3,08 m <sup>3</sup>	101,5 Kg	153 Kg	1
	W	180 cm				
	H	95 cm				
SX3	L	180 cm	3,08 m <sup>3</sup>	113,5 Kg	165 Kg	1
	W	180 cm				
	H	95 cm				
SX4	L	180 cm	3,08 m <sup>3</sup>	116,5 Kg	168 Kg	1
	W	180 cm				
	H	95 cm				
SX5	L	180 cm	3,08 m <sup>3</sup>	99 Kg	150,5 Kg	1
	W	180 cm				
	H	95 cm				

# SOLEIL ROUND

bathtubs - baignoires

## SOLEIL ROUND Ø170 cm.

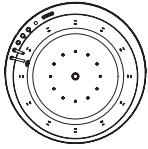

Water volume 500 l.  
Volume d'eau 500 l.

		FINISH FINITION	BRASSWARE ROBINETTERIE	SAP	KEA	€
<b>BASIC</b>			(1)	100078588	N710000237	2.586,00 €
			(2)	100078406	N710000230	3.563,00 €
<b>BATH WITH FRAME CHASSIS SANS HYDROMASSAGE</b>		built-in encastrément	-	100078411	N710000325	4.660,00 €
			(3)	100078412	N710000293	5.595,00 €
			-	100078407	N710000288	6.188,00 €
			(3)	100078408	N710000279	7.123,00 €
<b>S0</b>		built-in encastrément	(2)	100078416	N710000181	6.695,00 €
			-	100078589	N710000194	7.917,00 €
			(2)	100078413	N710000266	8.913,00 €
<b>SX1</b>		built-in encastrément	-	100078421	N710000332	7.159,00 €
			(3)	100078422	N710000268	8.094,00 €
			-	100078417	N710000200	8.688,00 €
			(3)	100078418	N710000297	9.623,00 €
<b>SX2</b>		built-in encastrément	-	100078428	N710000244	7.346,00 €
			(3)	100078429	N710000311	8.282,00 €
			-	100078423	N710000270	8.875,00 €
			(3)	100078424	N710000317	9.810,00 €
<b>SX3</b>		built-in encastrément	-	100078434	N710000359	9.141,00 €
			(3)	100078435	N710000310	10.076,00 €
			-	100078430	N710000261	10.668,00 €
			(3)	100078431	N710000205	11.603,00 €
<b>SX4</b> <sup>(4)</sup>			-	100078436	N710000265	12.958,00 €
			(3)	100078437	N710000302	13.894,00 €
<b>SX5</b> <sup>(4)</sup>			-	100078440	N710000225	10.477,00 €
			(3)	100078441	N710000189	11.412,00 €



<sup>(1)</sup> Bath waste not included • Vidage non inclus

<sup>(2)</sup> Deck mounted bath filler set, Bath waste and overflow set included • Robinetterie avec bec sur plage, Vidage automatique inclus

<sup>(3)</sup> Deck mounted bath filler set • Robinetterie avec bec sur plage





















- Up-Down waste hidden overflow • Vidage Up-Down trop plein caché

<sup>(4)</sup> Make sure that all the important equipment and LED lights can be easily accessed  
Ne doit pas être encastrée sans possibilité d'accéder aux spots

# SOLEIL ROUND

bathbubs - baignoires

## ACCESSORIES • ACCESSOIRES

	DESCRIPTION DESCRIPTION	COLOUR COULEUR	SAP	KEA	€	BASIC	FRAME CHASSIS	S0	SX1	SX2	SX3	SX4	SX5
	<sup>(1)</sup> L-110 NEXT Bath waste and overflow set including bath trap • <i>Vidage automatique NEXT L-110 + Siphon</i>		100080172	N770000154	73,00 €	✓		✓					
	MILD head rest • <i>Appui-tête ENJOY</i>		100066187	N770000050	91,00 €	✓	✓	✓	✓	✓	✓	✓	✓
	ENJOY head rest • <i>Appui-tête ENJOY</i>		100056383	N770000007	239,00 €								
			100056384	N770000034	239,00 €	✓	✓		✓				
			100056387	N770000017	239,00 €								
	ENJOY "S" head rest • <i>Appui-tête ENJOY "S"</i>		100060780	N770000049	198,00 €								
			100060753	N770000065	198,00 €	✓	✓	✓	✓	✓	✓	✓	✓
			100060767	N770000057	198,00 €								
	<sup>(2)</sup> Set of universal support XL frame with feet • <i>Châssis avec jeu de pieds universel</i>		100096848	N710000628	75,00 €	✓							
	<sup>(3)</sup> Bath access panel • <i>Trappe de visite baignoire</i>		250021559	N790001316	331,00 €	✓	✓	✓	✓	✓	✓		

<sup>(1)</sup> Only required for the models not including brassware • *Nécessaire uniquement pour les modèles sans robinetterie*

<sup>(2)</sup> Recommended use of 2 sets • *On recommande 2 jeux pour ce modèle*

<sup>(3)</sup> Required for all built-in installations • *Nécessaire pour tous les modèles encastrés*

# SOLEIL SQUARE

bathtubs - baignoires



bathtubs / baignoires SOLEIL SQUARE

## COLOURS • COULEURS

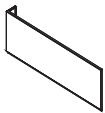

white acrylic  
acrylique blanc



chrome / white  
chromé / blanc



Chrome  
Chromé

## ACCESSORIES • ACCESSOIRES



ENJOY head rest  
Appui-tête ENJOY



ENJOY "S" head rest  
Appui-tête ENJOY "S"



COLD head rest  
appui-tête COLD

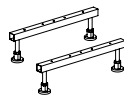

Set of universal support  
frame with feet  
Châssis universel avec  
pieds

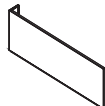

SQUARE panel  
tablier SQUARE



access panel  
trappe de visite



Up-Down waste hidden overflow  
Vidage Up-Down trop plein caché



bath waste and  
overflow set  
vidage automatique



deck mounted bath filler set  
Robinetterie avec bec sur  
plage

## SIZES cm. • FORMATS cm.





160x160 • 67h



# SOLEIL SQUARE

bathtubs - baignoires

## EQUIPMENT • EQUIPEMENT

		S0	SX1	SX2	SX3	SX4	SX5
JETS		9	-	15	15	15	-
BLOWERS		-	22	-	22	22	22
CHROMOTHERAPY CHROMOTHERAPIE		-	-	-	-	15	15
DISINFECTION DÉSINFECTION		-	-	-	-	✓	-

See features on page 22-25.

Consultez caractéristiques en page 22-25.

## DRAWINGS mm. • PLANS mm.

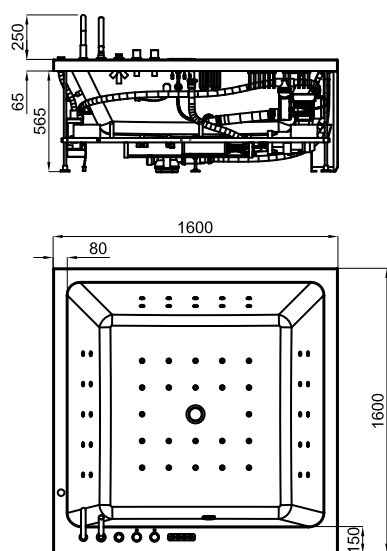

## PRE-INSTALLING • PRE-INSTALLATION

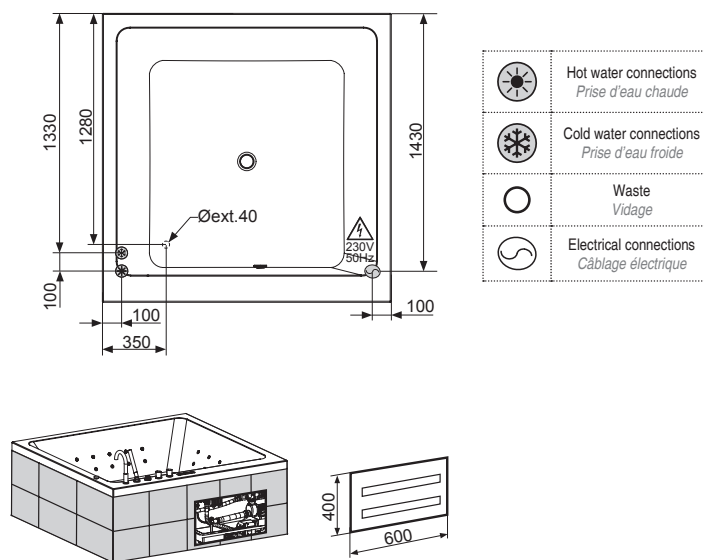

## PACKAGING DETAILS • DONNÉES D'EXPÉDITION

	DIMENSIONS DIMENSIONS		VOLUME VOLUME	NET WEIGHT / PIECE POIDS NET / PIÈCE	GROSS WEIGHT / PALLET POIDS BRUT / PALETTE	PIECES / PALLET PIÈCES / PALETTE
BASIC	L	180 cm	4,54 m <sup>3</sup>	45 Kg	470 Kg	10
	W	180 cm				
	H	140 cm				
BATH WITH FRAME CHASSIS SANS HYDROMASSAGE	L	180 cm	3,01 m <sup>3</sup>	77,5 Kg	109,5 Kg	1
	W	180 cm				
	H	93 cm				
S0	L	180 cm	3,01 m <sup>3</sup>	84,1 Kg	116,1 Kg	1
	W	180 cm				
	H	93 cm				
SX1	L	180 cm	3,01 m <sup>3</sup>	86,32 Kg	118,32 Kg	1
	W	180 cm				
	H	93 cm				
SX2	L	180 cm	3,01 m <sup>3</sup>	86,32 Kg	118,32 Kg	1
	W	180 cm				
	H	93 cm				
SX3	L	180 cm	3,01 m <sup>3</sup>	91,58 Kg	123,58 Kg	1
	W	180 cm				
	H	93 cm				
SX4	L	180 cm	3,01 m <sup>3</sup>	127,37 Kg	159,37 Kg	1
	W	180 cm				
	H	93 cm				
SX5	L	180 cm	3,01 m <sup>3</sup>	95,79 Kg	127,79 Kg	1
	W	180 cm				
	H	93 cm				

## SOLEIL SQUARE 160x160 cm.

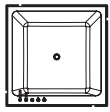

center

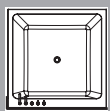

enter

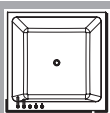

right  
droite

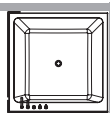

left  
gauche

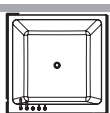

wall  
mur

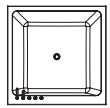

built-in  
encastrement

Water volume 564 l.  
Volume d'eau 564 l.

	POSITION POSITION	BRASSWARE ROBINETTERIE	SAP	KEA	€
<b>BASIC</b>		(1)	100094977	N710000394	2.243,00 €
		(2)	100094939	N710000372	3.114,00 €
<b>BATH WITH FRAME CHASSIS SANS HY- DROMAS- SAGE</b>	built-in encastrement	-	100094980	N710000370	3.895,00 €
		(3)	100094942	N710000397	4.813,00 €
	wall mur	-	100094983	N710000381	4.970,00 €
		(3)	100094945	N710000395	5.887,00 €
	right droite	-	100094979	N710000564	4.812,00 €
		(3)	100094941	N710000452	5.729,00 €
	left gauche	-	100094982	N710000508	4.812,00 €
		(3)	100094944	N710000393	5.729,00 €
	enter	-	100094981	N710000461	4.484,00 €
		(3)	100094943	N710000516	5.402,00 €
	center	-	100094978	N710000363	5.364,00 €
		(3)	100094940	N710000411	6.281,00 €
<b>S0</b>	built-in encastrement	-	100094986	N710000435	5.389,00 €
		(2)	100094948	N710000485	6.277,00 €
	wall mur	-	100094989	N710000481	6.367,00 €
		(2)	100094951	N710000356	7.255,00 €
	right droite	-	100094985	N710000425	6.223,00 €
		(2)	100094947	N710000449	7.111,00 €
	left gauche	-	100094988	N710000460	6.223,00 €
		(2)	100094950	N710000520	7.111,00 €
	enter	-	100094987	N710000408	5.925,00 €
		(2)	100094949	N710000382	6.813,00 €
	center	-	100094984	N710000429	6.724,00 €
		(2)	100094946	N710000521	7.612,00 €
<b>SX1</b>	built-in encastrement	-	100094992	N710000453	6.633,00 €
		(3)	100094954	N710000428	7.549,00 €
	wall mur	-	100094995	N710000403	7.707,00 €
		(3)	100094996	N710000437	8.625,00 €
	right droite	-	100094991	N710000391	7.549,00 €
		(3)	100094953	N710000573	8.466,00 €
	left gauche	-	100094994	N710000405	7.549,00 €
		(3)	100094956	N710000536	8.466,00 €
	enter	-	100094993	N710000455	7.222,00 €
		(3)	100094955	N710000459	8.139,00 €
	center	-	100094990	N710000407	8.101,00 €
		(3)	100094952	N710000527	9.018,00 €



<sup>(1)</sup>Waste included • Vidage inclus

<sup>(2)</sup> Deck mounted bath filler set, Bath waste and overflow set included • Robinetterie avec bec sur plage, Vidage automatique inclus

<sup>(3)</sup> Deck mounted bath filler set • Robinetterie avec bec sur plage



- Up-Down waste hidden overflow • Vidage Up-Down trop plein caché

# SOLEIL SQUARE

bathtubs - baignoires

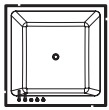

center

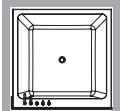

enter

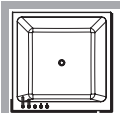

right  
droite

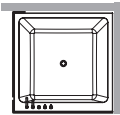

left  
gauche

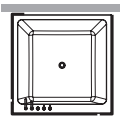

wall  
mur

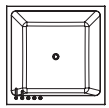

built-in  
encastrement

Water volume 564 l.  
Volume d'eau 564 l.

		POSITION POSITION	BRASSWARE ROBINETTERIE	SAP	KEA	€
SX2		built-in encastrement	-	100095001	N710000438	6.568,00 €
			(3)	100095002	N710000567	7.484,00 €
		wall mur	-	100095007	N710000507	7.642,00 €
			(3)	100095008	N710000465	8.560,00 €
		right droite	-	100094999	N710000409	7.484,00 €
			(3)	100095000	N710000467	8.401,00 €
		left gauche	-	100095005	N710000416	7.484,00 €
(3)	100095006	N710000471	8.401,00 €			
enter	(3)	100095003	N710000495	7.157,00 €		
SX3		built-in encastrement	-	100095013	N710000432	8.776,00 €
			(3)	100095014	N710000472	9.693,00 €
		wall mur	-	100095019	N710000494	9.851,00 €
			(3)	100095020	N710000388	10.768,00 €
		right droite	-	100095011	N710000571	9.693,00 €
			(3)	100095012	N710000490	10.609,00 €
		left gauche	-	100095017	N710000436	9.693,00 €
(3)	100095018	N710000510	10.609,00 €			
enter	(3)	100095015	N710000486	9.365,00 €		
SX4 (4)		wall mur	-	100095023	N710000451	12.087,00 €
			(3)	100095024	N710000346	13.003,00 €
		center	-	100095021	N710000504	12.480,00 €
			(3)	100095022	N710000513	13.398,00 €
SX5 (4)		wall mur	-	100095027	N710000446	9.357,00 €
			(3)	100095028	N710000415	10.274,00 €
		center	-	100095025	N710000484	10.236,00 €
			(3)	100095026	N710000412	11.153,00 €



<sup>(1)</sup>Waste included • Vidage inclus

<sup>(2)</sup> Deck mounted bath filler set, Bath waste and overflow set included • Robinetterie avec bec sur plage, Vidage automatique inclus















<sup>(3)</sup> Deck mounted bath filler set • Robinetterie avec bec sur plage



- Up-Down waste hidden overflow • Vidage Up-Down trop plein caché

<sup>(4)</sup> Make sure that all the important equipment and LED lights can be easily accessed  
Ne doit pas être encastrée sans possibilité d'accéder aux spots

ACCESSORIES • ACCESSOIRES

	DESCRIPTION DESCRIPTION	COLOUR COULEUR	SAP	KEA	€	BASIC	FRAME CHASSIS	S0	SX1	SX2	SX3	SX4	SX5
	<sup>(1)</sup> L-110 NEXT Bath waste and overflow set including bath trap • <i>Vidage automatique NEXT L-110 + Siphon</i>		100080172	N770000154	73,00 €	✓		✓					
	COLD head rest • <i>Appui-tête COLD</i>		100066186	N770000052	91,00 €	✓	✓	✓	✓	✓	✓	✓	✓
	ENJOY head rest • <i>Appui-tête ENJOY</i>		100056383	N770000007	239,00 €								
			100056384	N770000034	239,00 €	✓	✓		✓				
			100056387	N770000017	239,00 €								
	ENJOY "S" head rest • <i>Appui-tête ENJOY "S"</i>		100060780	N770000049	198,00 €								
			100060753	N770000065	198,00 €	✓	✓	✓	✓	✓	✓	✓	✓
			100060767	N770000057	198,00 €								
	<sup>(2)</sup> Set of universal support XL frame with feet • <i>Châssis universel XL avec pieds</i>		100096848	N710000628	75,00 €	✓							
	<sup>(3)</sup> Bath access panel • <i>Trappe de visite baignoire</i>		250021559	N790001316	331,00 €	✓	✓	✓	✓	✓	✓	✓	✓

<sup>(1)</sup> Only required for the models not including brassware • *Nécessaire uniquement pour les modèles sans robinetterie*

<sup>(2)</sup> Recommended use of 2 sets • *On recommande 2 jeux pour ce modèle*

<sup>(3)</sup> Required for all built-in installations • *Nécessaire pour tous les modèles encastrés*

# SOLEIL OVAL

bathtubs - baignoires



bathtubs / baignoires SOLEIL OVAL

## COLOURS • COULEURS



white acrylic  
acrylique blanc



chrome / white  
chromé / blanc



Chrome  
Chromé

## ACCESSORIES • ACCESSOIRES



ENJOY head rest  
Appui-tête ENJOY



ENJOY "S" head rest  
Appui-tête ENJOY "S"



COLD head rest  
appui-tête COLD



Set of CASUAL PLUS  
support frame with feet  
châssis universel CASUAL  
PLUS



OVAL panel  
tablier OVAL



access panel  
trappe de visite



Up-Down waste hidden overflow  
Vidage Up-Down trop plein caché



bath waste and  
overflow set  
vidage automatique







deck mounted bath filler set  
Robinetterie avec bec sur  
plage

## SIZES cm. • FORMATS cm.

180x90 • 67h

## EQUIPMENT • EQUIPEMENT

		S0	SX1	SX2	SX3	SX4	SX5
JETS		6	-	10	10	10	-
BLOWERS		-	9	-	9	9	9
CHROMOTHERAPY CHROMOTHERAPIE		-	-	-	-	10	10
DISINFECTION DÉSINFECTION		-	-	-	-	✓	-



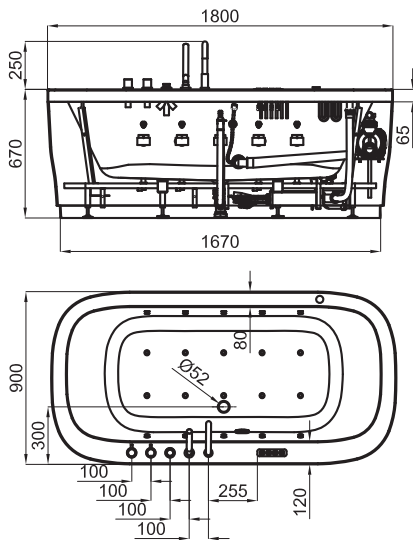

See features on page 22-25.  
Consultez caractéristiques en page 22-25.

## DRAWINGS mm. • PLANS mm.

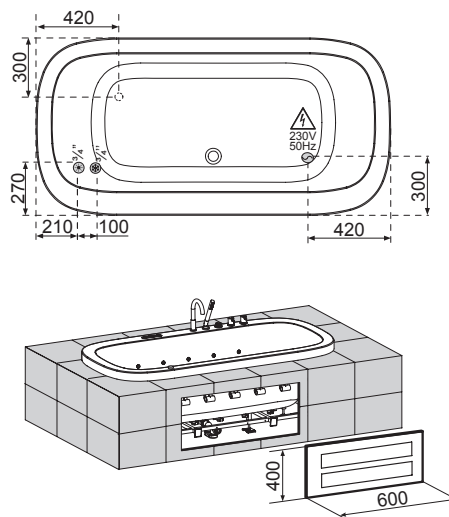

## PRE-INSTALLING • PRE-INSTALLATION



	Hot water connections Prise d'eau chaude
	Cold water connections Prise d'eau froide
	Waste Vidage
	Electrical connections Câblage électrique

## PACKAGING DETAILS • DONNÉES D'EXPÉDITION

	DIMENSIONS DIMENSIONS		VOLUME VOLUME	NET WEIGHT / PIECE POIDS NET / PIÈCE	GROSS WEIGHT / PALLET POIDS BRUT / PALETTE	PIECES / PALLET PIÈCES / PALETTE
BASIC	L	185 cm	2,63 m <sup>3</sup>	33,8 Kg	358Kg	10
	W	95 cm				
	H	150 cm				
BATH WITH FRAME CHASSIS SANS HYDROMAS- SAGE	L	185 cm	1,32 m <sup>3</sup>	44 Kg	57 Kg	1
	W	95 cm				
	H	75 cm				
CENTER	L	185 cm	1,32 m <sup>3</sup>	58 Kg	71 Kg	1
	W	95 cm				
	H	75 cm				
S0	L	185 cm	1,32 m <sup>3</sup>	68 Kg	81 Kg	1
	W	95 cm				
	H	75 cm				
SX1	L	185 cm	1,32 m <sup>3</sup>	68 Kg	81 Kg	1
	W	95 cm				
	H	75 cm				
SX2	L	185 cm	1,32 m <sup>3</sup>	73 Kg	86 Kg	1
	W	95 cm				
	H	75 cm				
SX3	L	185 cm	1,32 m <sup>3</sup>	78 Kg	91 Kg	1
	W	95 cm				
	H	75 cm				
SX4	L	185 cm	1,32 m <sup>3</sup>	83 Kg	96 Kg	1
	W	95 cm				
	H	75 cm				
SX5	L	185 cm	1,32 m <sup>3</sup>	78 Kg	91 Kg	1
	W	95 cm				
	H	75 cm				

# SOLEIL OVAL

bathbats - baignoires

## SOLEIL OVAL 180x90 cm.

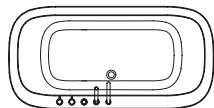

Water volume 500 l.  
Volume d'eau 500 l.

		FINISH FINITION	BRASSWARE ROBINETTERIE	SAP	KEA	€
<b>BASIC</b>			(1)	100099293	N710000637	848,00 €
			(2)	100099294	N710000672	2.366,00 €
<b>BATH WITH FRAME CHASSIS SANS HYDROMASSAGE</b>		built-in encastrement	-	100099036	N710000643	1.724,00 €
			(3)	100099037	N710000649	2.865,00 €
			-	100099584	N710000673	3.524,00 €
			(3)	100099445	N710000616	5.038,00 €
<b>S0</b>		built-in encastrement	-	100099042	N710000666	2.572,00 €
			(2)	100099043	N710000576	3.431,00 €
			-	100099038	N710000561	5.194,00 €
			(2)	100099039	N710000624	6.060,00 €
<b>SX1</b>		built-in encastrement	-	100099052	N710000525	4.278,00 €
			(3)	100099053	N710000705	5.131,00 €
			-	100099048	N710000574	7.422,00 €
			(3)	100099049	N710000625	8.312,00 €
<b>SX2</b>		built-in encastrement	-	100099058	N710000786	4.377,00 €
			(3)	100099059	N710000541	5.260,00 €
			-	100099054	N710000635	6.772,00 €
			(3)	100099055	N710000775	7.591,00 €
<b>SX3</b>		built-in encastrement	-	100099067	N710000585	6.351,00 €
			(3)	100099068	N710000601	7.204,00 €
			-	100099063	N710000634	8.639,00 €
			(3)	100099064	N710000670	9.506,00 €
<b>SX4</b> (4)			-	100099069	N710000592	10.869,00 €
			(3)	100099070	N710000657	11.673,00 €
<b>SX5</b> (4)			-	100099086	N710000477	8.512,00 €
			(3)	100099087	N710000754	9.356,00 €



(1) Bath waste not included • Vidage non inclus

(2) Deck mounted bath filler set, Bath waste and overflow set included • Robinetterie avec bec sur plage, Vidage automatique inclus















(3) Deck mounted bath filler set • Robinetterie avec bec sur plage



- Up-Down waste hidden overflow • Vidage Up-Down trop plein caché

(4) Make sure that all the important equipment and LED lights can be easily accessed  
Ne doit pas être encastrée sans possibilité d'accéder aux spots

ACCESSORIES • ACCESSOIRES

	DESCRIPTION DESCRIPTION	COLOUR COULEUR	SAP	KEA	€	BASIC	FRAME CHASSIS	S0	SX1	SX2	SX3	SX4	SX5
	<sup>(1)</sup> Bath waste and overflow set NEXT + Syphon • Vidage automatique NEXT + Syphon		100060498	N780000002	51,00 €	✓		✓					
	COLD head rest • Appui-tête COLD		100066186	N770000052	91,00 €	✓	✓	✓	✓	✓	✓	✓	✓
			100056383	N770000007	239,00 €								
	ENJOY head rest • Appui-tête ENJOY		100056384	N770000034	239,00 €	✓	✓	✓	✓	✓	✓	✓	✓
			100056387	N770000017	239,00 €								
			100060780	N770000049	198,00 €								
	ENJOY "S" head rest • Appui-tête ENJOY "S"		100060753	N770000065	198,00 €	✓	✓	✓	✓	✓	✓	✓	✓
			100060767	N770000057	198,00 €								
	<sup>(2)</sup> Set of CASUAL PLUS support frame with feet • Kit châssis universel CASUAL PLUS		100060499	N770000066	49,00 €	✓							
	<sup>(3)</sup> Bath access panel • Trappe de visite baignoire		250021559	N790001316	331,00 €	✓	✓	✓	✓	✓	✓		

<sup>(1)</sup> Only required for the models not including brassware • Nécessaire uniquement pour les modèles sans robinetterie

<sup>(2)</sup> Recommended use of 2 sets • On recommande 2 jeux pour ce modèle

<sup>(3)</sup> Required for all built-in installations • Nécessaire pour tous les modèles encastrés



# SOLEIL QUADRA

bathtubs - baignoires



bathtubs / baignoires SOLEIL QUADRA

## COLOURS • COULEURS

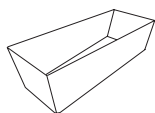

white acrylic  
acrylique blanc



chrome / white  
chromé / blanc



Chrome  
Chromé

## ACCESSORIES • ACCESSOIRES



ENJOY head rest  
Appui-tête ENJOY



ENJOY "S" head rest  
Appui-tête ENJOY "S"



COLD head rest  
appui-tête COLD

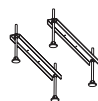

Set of CASUAL PLUS  
support frame with feet  
châssis universel CASUAL  
PLUS

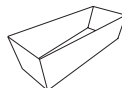

QUADRA panel  
tablier QUADRA



access panel  
trappe de visite



bath waste and  
overflow set  
vidage automatique













deck mounted bath filler set  
Robinetterie avec bec sur  
plage

## SIZES cm. • FORMATS cm.

180 x 80 • 60h

## EQUIPMENT • EQUIPEMENT

							
	S0	SX1	SX2	SX3	SX4	SX5	
JETS		6	-	10	10	10	-
BLOWERS		-	9	-	9	9	9
CHROMOTHERAPY CHROMOTHERAPIE		-	-	-	10	10	-
DISINFECTION DÉSINFECTION		-	-	-	✓	-	-

See features on page 22-25.  
Consultez caractéristiques en page 22-25.

## DRAWINGS mm. • PLANS mm.

### CENTER (SX)

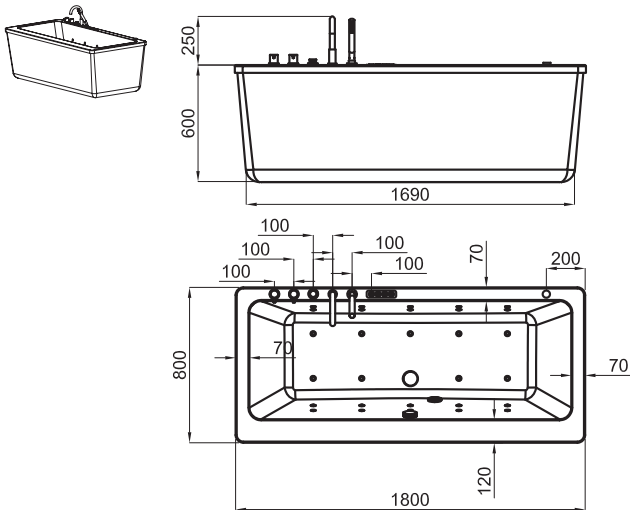

### BUILT-IN • ENCASTREMENT

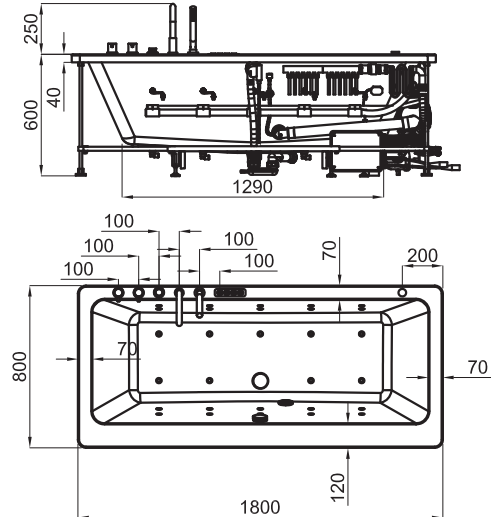



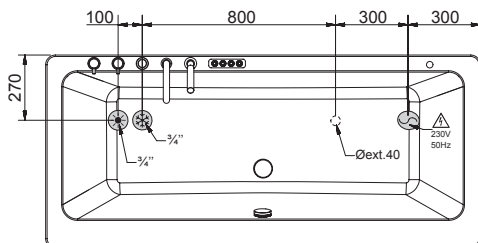

## PRE-INSTALLING • PRE-INSTALLATION

### CENTER (SX)

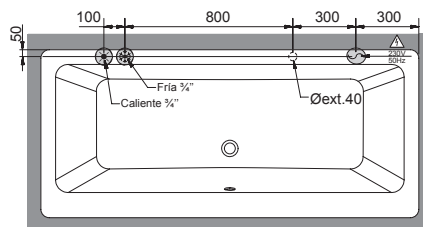

### BUILT-IN • ENCASTREMENT



	Hot water connections Prise d'eau chaude
	Cold water connections Prise d'eau froide
	Waste Vidage
	Electrical connections Câblage électrique

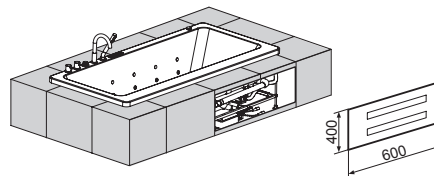

## PACKAGING DETAILS • DONNÉES D'EXPÉDITION

	DIMENSIONS DIMENSIONS		VOLUME VOLUME	NET WEIGHT / PIECE POIDS NET / PIÈCE	GROSS WEIGHT / PALLET POIDS BRUT / PALETTE	PIECES / PALLET PIÈCES / PALETTE
BASIC	L W H	120 cm 87 cm 200 cm	2,09 m <sup>3</sup>	35,2 Kg	301,4 Kg	8
BATH WITH FRAME CHASSIS SANS HYDROMAS- SAGE	L W H	184 cm 84 cm 82 cm	1,27 m <sup>3</sup>	60,1 Kg	77 Kg	1
S0	L W H	184 cm 84 cm 82 cm	1,27 m <sup>3</sup>	71,6 Kg	88,5 Kg	1
SX1	L W H	184 cm 84 cm 82 cm	1,27 m <sup>3</sup>	69,1 Kg	86 Kg	1
SX2	L W H	184 cm 84 cm 82 cm	1,27 m <sup>3</sup>	93,6 Kg	110,5 Kg	1
SX3	L W H	184 cm 84 cm 82 cm	1,27 m <sup>3</sup>	102,6 Kg	119,5 Kg	1
SX4	L W H	184 cm 84 cm 82 cm	1,27 m <sup>3</sup>	105,6 Kg	122,5 Kg	1
SX5	L W H	184 cm 84 cm 82 cm	1,27 m <sup>3</sup>	70,1 Kg	87 Kg	1

# SOLEIL QUADRA

bathtubs - baignoires

## SOLEIL QUADRA 180x80 cm.

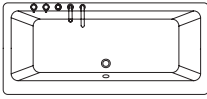

Water volume 214 l.  
Volume d'eau 214 l.

		FINISH FINITION	BRASSWARE ROBINETTERIE	SAP	KEA	€
<b>BASIC</b>			(1)	100050674	N71000033	709,00 €
			(2)	100050676	N71000043	2.141,00 €
<b>BATH WITH FRAME CHASSIS SANS HYDROMASSAGE</b>		built-in encastrément	(1)	100084751	N710000478	1.558,00 €
			(2)	100084752	N710000402	4.772,00 €
			(3)	100050673	N710000010	3.313,00 €
			(3)	100050675	N710000042	4.772,00 €
<b>S0</b>		built-in encastrément	(1)	100078688	N710000260	2.334,00 €
			(2)	100078653	N710000241	3.110,00 €
			(3)	100078689	N710000322	4.903,00 €
			(3)	100078654	N710000263	5.679,00 €
<b>SX1</b>		built-in encastrément	(2)	100078655	N710000195	3.887,00 €
			(2)	100078656	N710000327	4.662,00 €
			(3)	100078657	N710000240	7.092,00 €
			(3)	100078658	N710000277	7.868,00 €
<b>SX2</b>		built-in encastrément	(2)	100078659	N710000214	3.970,00 €
			(2)	100078660	N710000304	4.747,00 €
			(3)	100078661	N710000321	6.401,00 €
			(3)	100078662	N710000367	7.177,00 €
<b>SX3</b>		built-in encastrément	(2)	100078663	N710000276	5.766,00 €
			(2)	100078664	N710000287	6.542,00 €
			(3)	100078665	N710000307	8.196,00 €
			(3)	100078666	N710000228	8.972,00 €
<b>SX4</b> (4)			(3)	100078667	N710000323	10.299,00 €
			(3)	100078668	N710000291	11.075,00 €
<b>SX5</b> (4)			(3)	100078669	N710000375	8.106,00 €
			(3)	100078670	N710000305	8.881,00 €



(1) Bath waste not included • Vidage non inclus

(2) Deck mounted bath filler set, Bath waste and overflow set included • Robinetterie avec bec sur plage, Vidage automatique inclus

















(3) Deck mounted bath filler set • Robinetterie avec bec sur plage

(4) Make sure that all the important equipment and LED lights can be easily accessed  
Ne doit pas être encastrée sans possibilité d'accéder aux spots

# SOLEIL QUADRA

bathtubs - baignoires

## ACCESSORIES • ACCESSOIRES

	DESCRIPTION DESCRIPTION	COLOUR COULEUR	SAP	KEA	€	BASIC	FRAME CHASSIS	S0	SX1	SX2	SX3	SX4	SX5
	<sup>(1)</sup> Bath waste and overflow set NEXT + Syphon • Vidage automatique NEXT + Syphon		100060498	N780000002	51,00 €	✓	✓	✓					
	COLD head rest • Appui-tête COLD		100066186	N770000052	91,00 €	✓	✓	✓	✓	✓	✓	✓	✓
			100056383	N770000007	239,00 €								
	ENJOY head rest • Appui-tête ENJOY		100056384	N770000034	239,00 €	✓	✓	✓	✓	✓	✓	✓	✓
			100056387	N770000017	239,00 €								
			100060780	N770000049	198,00 €								
	ENJOY "S" head rest • Appui-tête ENJOY "S"		100060753	N770000065	198,00 €	✓	✓	✓	✓	✓	✓	✓	✓
			100060767	N770000057	198,00 €								
	<sup>(2)</sup> Set of CASUAL PLUS support frame with feet • Kit châssis universel CASUAL PLUS		100060499	N770000066	49,00 €	✓							
	<sup>(3)</sup> Bath access panel • Trappe de visite baignoire		250021559	N790001316	331,00 €	✓	✓	✓	✓	✓	✓		

<sup>(1)</sup> Only required for the models not including brassware • Nécessaire uniquement pour les modèles sans robinetterie

<sup>(2)</sup> Recommended use of 2 sets • On recommande 2 jeux pour ce modèle

<sup>(3)</sup> Required for all built-in installations • Nécessaire pour tous les modèles encastrés

# SOLEIL OFFSET

bathtubs - baignoires



bathtubs / baignoires SOLEIL OFFSET

## COLOURS • COULEURS



white acrylic  
acrylique blanc



chrome / white  
chromé / blanc



Chrome  
Chromé

## ACCESSORIES • ACCESSOIRES



ENJOY head rest  
Appui-tête ENJOY



ENJOY "S" head rest  
Appui-tête ENJOY "S"



COLD head rest  
appui-tête COLD

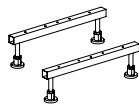

Set of universal support  
frame with feet  
châssis universel



OFFSET panel  
tablier OFFSET



access panel  
trappe de visite



Up-Down waste hidden overflow  
Vidage Up-Down trop plein caché



bath waste and  
overflow set  
vidage automatique



bath filler waste and over-  
flow set  
automatique vidage bec  
verseur



deck mounted bath filler set  
Robinetterie avec bec sur  
plage



deck mounted valves and  
handset  
robinetterie

# SOLEIL OFFSET

bathtubs - baignoires

## SIZES cm. • FORMATS cm.

170x120 • 65,5h

## EQUIPMENT • EQUIPEMENT

		S0	SX1	SX2	SX3	SX4	SX5
JETS		6	-	11	11	11	-
BLOWERS		-	12	-	12	12	12
CHROMOTHERAPY CHROMOTHERAPIE		-	-	-	-	8	8
DISINFECTION DÉSINFECTION		-	-	-	-	✓	-

See features on page 22-25.

Consultez caractéristiques en page 22-25.

## DRAWINGS mm. • PLANS mm.

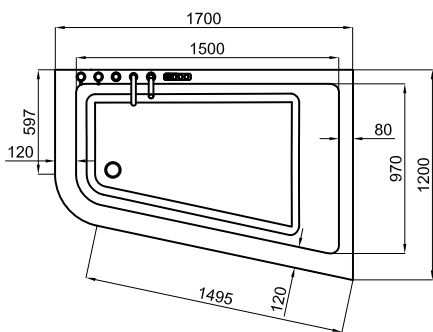
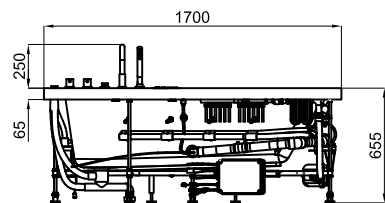

## PRE-INSTALLING • PRE-INSTALLATION

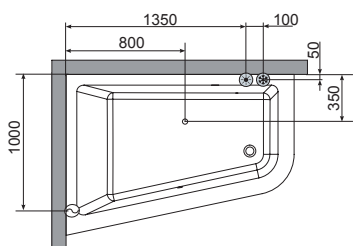

Left  
Gauche

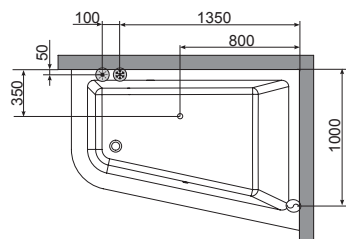

Right  
Droite

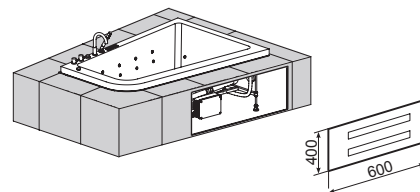

	Hot water connections Prise d'eau chaude
	Cold water connections Prise d'eau froide
	Waste Vidage
	Electrical connections Câblage électrique

# SOLEIL OFFSET

bathtubs - baignoires

## PACKAGING DETAILS • DONNÉES D'EXPÉDITION

	DIMENSIONS DIMENSIONS		VOLUME VOLUME	NET WEIGHT / PIECE POIDS NET / PIÈCE	GROSS WEIGHT / PALLET POIDS BRUT / PALETTE	PIECES / PALLET PIÈCES / PALETTE
BASIC	L	175 cm	3,07 m <sup>3</sup>	27,5 Kg	295 Kg	10
	W	125 cm				
	H	140 cm				
BATH WITH FRAME CHASSIS SANS HYDROMAS- SAGE	L	174 cm	2,01 m <sup>3</sup>	55,1 Kg	94,5 Kg	1
	W	124 cm				
	H	93 cm				
S0	L	174 cm	2,01 m <sup>3</sup>	64,6 Kg	104 Kg	1
	W	124 cm				
	H	93 cm				
SX1	L	174 cm	2,01 m <sup>3</sup>	65,7 Kg	105,1 Kg	1
	W	124 cm				
	H	93 cm				
SX2	L	174 cm	2,01 m <sup>3</sup>	67,8 Kg	107,2 Kg	1
	W	124 cm				
	H	93 cm				
SX3	L	174 cm	2,01 m <sup>3</sup>	78,4 Kg	117,8 Kg	1
	W	124 cm				
	H	93 cm				
SX4	L	174 cm	2,01 m <sup>3</sup>	81,4 Kg	120,8 Kg	1
	W	124 cm				
	H	93 cm				
SX5	L	174 cm	2,01 m <sup>3</sup>	66,6 Kg	106 Kg	1
	W	124 cm				
	H	93 cm				

## SOLEIL OFFSET 170x120 cm.

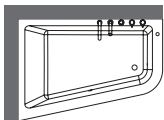

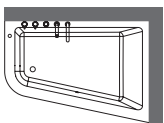

left  
gauche



right  
droite

Water volume 340 l.  
Volume d'eau 340 l.

	FINISH FINITION	BRASSWARE ROBINETTERIE	POSITION POSITION	SAP	KEA	€	
<b>BASIC</b> 		(1)	right • droite	100077228	N710000251	1.128,00 €	
			left • gauche	100077229	N710000319	1.128,00 €	
			right • droite	100077091	N710000296	1.990,00 €	
			left • gauche	100077092	N710000249	1.990,00 €	
<b>BATH WITH FRAME CHASSIS SANS HY- DROMAS- SAGE</b> 	built-in encastrement		right • droite	100077093	N710000210	2.295,00 €	
			left • gauche	100077095	N710000282	2.295,00 €	
			right • droite	100077094	N710000269	3.203,00 €	
			left • gauche	100077096	N710000187	3.203,00 €	
			(3)	right • droite	100077087	N710000198	2.902,00 €
				left • gauche	100077089	N710000165	2.902,00 €
				right • droite	100077088	N710000247	3.809,00 €
				left • gauche	100077090	N710000248	3.809,00 €
<b>S0</b> 	built-in encastrement		right • droite	100077232	N710000309	2.952,00 €	
			left • gauche	100077233	N710000295	2.952,00 €	
			right • droite	100077103	N710000290	3.831,00 €	
			left • gauche	100077104	N710000204	3.831,00 €	
			(2)	right • droite	100077230	N710000235	3.598,00 €
				left • gauche	100077231	N710000213	3.598,00 €
				right • droite	100077101	N710000281	4.477,00 €
				left • gauche	100077102	N710000234	4.477,00 €



(1) Bath waste not included • Vidage non inclus

(2) Deck mounted bath filler set, Bath waste and overflow set included • Robinetterie avec bec sur plaque, Vidage automatique inclus

(3) Deck mounted bath filler set • Robinetterie avec bec sur plaque



- Up-Down waste hidden overflow • Vidage Up-Down trop plein caché



# SOLEIL OFFSET

bathtubs - baignoires

## SOLEIL OFFSET 170x120 cm.

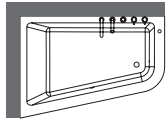

left  
gauche

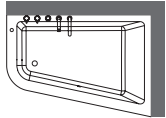

right  
droite

Water volume 340 l.  
Volume d'eau 340 l.

	FINISH FINITION	BRASSWARE ROBINETTERIE	POSITION POSITION	SAP	KEA	€
SX1	built-in encastrement	(3)	right • droite	100078198	N710000292	4.694,00 €
			left • gauche	100077113	N710000298	4.694,00 €
			right • droite	100077112	N710000255	5.602,00 €
	-		left • gauche	100077114	N710000285	5.602,00 €
			right • droite	100077109	N710000193	5.301,00 €
			left • gauche	100078197	N710000389	5.301,00 €
SX2	built-in encastrement	(3)	right • droite	100077110	N710000197	6.208,00 €
			left • gauche	100077111	N710000191	6.208,00 €
			right • droite	100077122	N710000223	4.833,00 €
	-		left • gauche	100077124	N710000254	4.833,00 €
			right • droite	100077123	N710000216	5.741,00 €
			left • gauche	100077125	N710000267	5.741,00 €
SX3	built-in encastrement	(3)	right • droite	100077118	N710000159	5.440,00 €
			left • gauche	100077120	N710000173	5.440,00 €
			right • droite	100077119	N710000253	6.347,00 €
	-		left • gauche	100077121	N710000257	6.347,00 €
			right • droite	100077134	N710000271	6.599,00 €
			left • gauche	100077136	N710000218	6.599,00 €
SX4 <sup>(4)</sup>	-	(3)	right • droite	100077135	N710000226	7.506,00 €
			left • gauche	100077137	N710000209	7.506,00 €
			right • droite	100077130	N710000316	7.205,00 €
	-		left • gauche	100077132	N710000264	7.205,00 €
			right • droite	100077131	N710000300	8.113,00 €
			left • gauche	100077133	N710000175	8.113,00 €
SX5 <sup>(4)</sup>	-	(3)	right • droite	100077142	N710000243	9.135,00 €
			left • gauche	100077144	N710000353	9.135,00 €
			right • droite	100077143	N710000222	10.042,00 €
			left • gauche	100077145	N710000219	10.042,00 €
SX5 <sup>(4)</sup>	-	(3)	right • droite	100077150	N710000177	6.769,00 €
			left • gauche	100077152	N710000286	6.769,00 €
			right • droite	100077151	N710000163	7.676,00 €
			left • gauche	100077153	N710000284	7.676,00 €



<sup>(1)</sup> Bath waste not included • Vidage non inclus

<sup>(2)</sup> Deck mounted bath filler set, Bath waste and overflow set included • Robinetterie avec bec sur plage, Vidage automatique inclus

<sup>(3)</sup> Deck mounted bath filler set • Robinetterie avec bec sur plage



- Up-Down waste hidden overflow  
Vidage Up-Down trap plein caché

<sup>(4)</sup> Make sure that all the important equipment and LED lights can be easily accessed  
Ne doit pas être encastrée sans possibilité d'accéder aux spots

### ACCESSORIES • ACCESSOIRES

	DESCRIPTION DESCRIPTION	COLOUR COULEUR	SAP	KEA	€	BASIC	FRAME CHASSIS	S0	SX1	SX2	SX3	SX4	SX5
	<sup>(1)</sup> Bath waste and overflow set NEXT + Syphon • Vidage automatique NEXT + Syphon		100060498	N780000002	51,00 €	✓		✓					
	<sup>(1)</sup> NEXT bath filler waste and overflow set including bath trap • Vidage NEXT avec bec verseur + Syphon		100060521	N780000008	130,00 €	✓		✓					
	COLD head rest • Appui-tête COLD		100066186	N770000052	91,00 €	✓	✓	✓	✓	✓	✓	✓	✓
	ENJOY head rest • Appui-tête ENJOY		100056383	N770000007	239,00 €								
			100056384	N770000034	239,00 €	✓	✓	✓	✓				
			100056387	N770000017	239,00 €								
	ENJOY "S" head rest • Appui-tête ENJOY "S"		100060780	N770000049	198,00 €								
			100060753	N770000065	198,00 €	✓	✓	✓	✓	✓	✓	✓	✓
			100060767	N770000057	198,00 €								
	<sup>(2)</sup> Set of XL support frame with feet • Kit châssis universel XL		100096848	N710000628	75,00 €	✓							
	<sup>(3)</sup> Bath access panel • Trappe de visite baignoire		250021559	N790001316	331,00 €	✓	✓	✓	✓	✓	✓		

<sup>(1)</sup> Only required for the models not including brassware • Nécessaire uniquement pour les modèles sans robinetterie

<sup>(2)</sup> Recommended use of 2 sets • On recommande 2 jeux pour ce modèle

<sup>(3)</sup> Required for all built-in installations • Nécessaire pour tous les modèles encastrés

# SOLEIL SINGLE

bathtubs - baignoires



bathtubs / baignoires SOLEIL SINGLE

## COLOURS • COULEURS



CLUB panel  
tablier CLUB



white  
blanc



black  
noir



Inox



MODUL panel  
tablier MODUL



white  
blanc



chrome / white  
chromé / blanc



Chrome  
Chromé

## ACCESSORIES • ACCESSOIRES



ENJOY head rest  
Appui-tête ENJOY



ENJOY "S" head rest  
Appui-tête ENJOY "S"



COLD head rest  
appui-tête COLD



Set of universal support  
frame with feet CASUAL  
châssis universel  
CASUAL



CLUB panel  
tablier CLUB



MODUL panel  
tablier MODUL



access panel  
trappe de visite



bath waste and  
overflow set  
vidage automatique



bath filler waste and over-  
flow set  
automatique vidage bec  
verseur



deck mounted valves and  
handset  
robinetterie

# SOLEIL SINGLE

bathtubs - baignoires

## SIZES cm. • FORMATS cm.

160x70 • 62,5h  
170x75 • 62,5h  
180x80 • 62,5h

## EQUIPMENT • EQUIPEMENT

		S0	SX1	SX2	SX3	SX4	SX5
JETS		6	-	8	8	8	-
BLOWERS		-	8	-	8	8	8
CHROMOTHERAPY CHROMOTHERAPIE		-	-	-	-	8	8
DISINFECTION DÉSINFECTION		-	-	-	-	✓	-

See features on page 22-25.

Consultez caractéristiques en page 22-25.

## DRAWINGS mm. • PLANS mm.

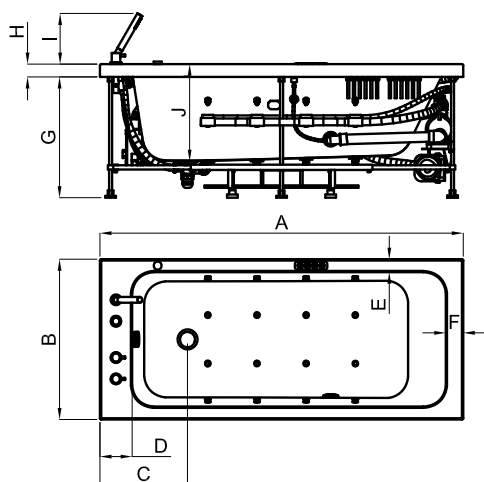

mm	A	B	C	D	E	F	G	H	I	J
1600 x 700	1600	700								
1700 x 750	1700	750	415	150	60	80	565	60	250	450
1800 x 800	1800	800								

## PRE-INSTALLING • PRE-INSTALLATION

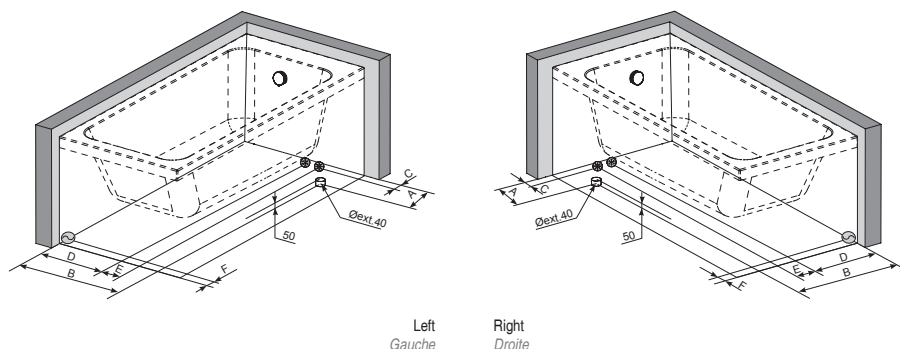

Left  
Gauche

Right  
Droite

	Hot water connections Prise d'eau chaude
	Cold water connections Prise d'eau froide
	Waste Vidage
	Electrical connections Câblage électrique

mm	A	B	C	D	E	F
1600 x 700						
1700 x 750	220	600	50	400	100	50
1800 x 800						

## PACKAGING DETAILS • DONNÉES D'EXPÉDITION

		DIMENSIONS DIMENSIONS		VOLUME VOLUME	NET WEIGHT / PIECE POIDS NET / PIÈCE	GROSS WEIGHT / PALLET POIDS BRUT / PALETTE	PIECES / PALLET PIÈCES / PALETTE
160x70	BASIC	L W H	130 cm 72 cm 140 cm	1,31 m <sup>3</sup>	20 Kg	220 Kg	10
	BATH WITH FRAME CHASSIS SANS HYDROMAS- SAGE	L W H	163 cm 73 cm 81 cm	0,96 m <sup>3</sup>	33 Kg	45 Kg	1
	S0	L W H	163 cm 73 cm 81 cm	0,96 m <sup>3</sup>	48 Kg	60 Kg	1
	SX1	L W H	163 cm 73 cm 81 cm	0,96 m <sup>3</sup>	49 Kg	61 Kg	1
	SX2	L W H	163 cm 73 cm 81 cm	0,96 m <sup>3</sup>	49 Kg	61 Kg	1
	SX3	L W H	163 cm 73 cm 81 cm	0,96 m <sup>3</sup>	56 Kg	68 Kg	1
	SX4	L W H	163 cm 73 cm 81 cm	0,96 m <sup>3</sup>	61 Kg	73 Kg	1
	SX5	L W H	163 cm 73 cm 81 cm	0,96 m <sup>3</sup>	49 Kg	61 Kg	1
170x75	BASIC	L W H	130 cm 77 cm 140 cm	1,4 m <sup>3</sup>	24 Kg	260 Kg	10
	BATH WITH FRAME CHASSIS SANS HYDROMAS- SAGE	L W H	173 cm 78 cm 81 cm	1,09 m <sup>3</sup>	37 Kg	49 Kg	1
	S0	L W H	173 cm 78 cm 81 cm	1,09 m <sup>3</sup>	52 Kg	64 Kg	1
	SX1	L W H	173 cm 78 cm 81 cm	1,09 m <sup>3</sup>	53 Kg	65 Kg	1
	SX2	L W H	173 cm 78 cm 81 cm	1,09 m <sup>3</sup>	53 Kg	65 Kg	1
	SX3	L W H	173 cm 78 cm 81 cm	1,09 m <sup>3</sup>	60 Kg	72 Kg	1
	SX4	L W H	173 cm 78 cm 81 cm	1,09 m <sup>3</sup>	65 Kg	77 Kg	1
	SX5	L W H	173 cm 78 cm 81 cm	1,09 m <sup>3</sup>	53 Kg	65 Kg	1

## PACKAGING DETAILS • DONNÉES D'EXPÉDITION

		DIMENSIONS DIMENSIONS		VOLUME VOLUME	NET WEIGHT / PIECE POIDS NET / PIÈCE	GROSS WEIGHT / PALLET POIDS BRUT / PALETTE	PIECES / PALLET PIÈCES / PALETTE
180x80	BASIC	L W H	130 cm 82 cm 140 cm	1,50 m <sup>3</sup>	29 Kg	310 Kg	10
	BATH WITH FRAME CHASSIS SANS HYDROMASSAGE	L W H	183 cm 83 cm 81 cm	1,23 m <sup>3</sup>	38 Kg	50 Kg	1
	S0	L W H	183 cm 83 cm 81 cm	1,23 m <sup>3</sup>	53 Kg	65 Kg	1
	SX1	L W H	183 cm 83 cm 81 cm	1,23 m <sup>3</sup>	54 Kg	66 Kg	1
	SX2	L W H	183 cm 83 cm 81 cm	1,23 m <sup>3</sup>	54 Kg	66 Kg	1
	SX3	L W H	183 cm 83 cm 81 cm	1,23 m <sup>3</sup>	61 Kg	73 Kg	1
	SX4	L W H	183 cm 83 cm 81 cm	1,23 m <sup>3</sup>	66 Kg	78 Kg	1
	SX5	L W H	183 cm 83 cm 81 cm	1,23 m <sup>3</sup>	54 Kg	66 Kg	1

# SOLEIL SINGLE

bathtubs - baignoires

## SOLEIL SINGLE 160x70 cm.

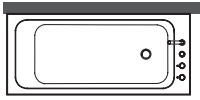

left  
gauche



right  
droite

Water volume 203 l.  
Volume d'eau 203 l.

		FINISH FINITION	BRASSWARE ROBINETTERIE	SAP	KEA	€
<b>BASIC</b>			(1)	100096495	N710000526	528,00 €
			(2)	100096498	N710000652	1.598,00 €
<b>BATH WITH FRAME CHASSIS SANS HYDROMAS- SAGE</b>			-	100096499	N710000595	1.094,00 €
			(2)	100096500	N710000586	2.217,00 €
<b>S0</b>		right droite	-	100096501	N710000578	2.316,00 €
			(2)	100096502	N710000640	3.404,00 €
		left gauche	-	100096503	N710000663	2.316,00 €
			(2)	100096504	N710000572	3.404,00 €
<b>SX1</b>		right droite	-	100096305	N710000441	3.377,00 €
			(2)	100096330	N710000550	4.291,00 €
		left gauche	-	100096306	N710000515	3.377,00 €
			(2)	100096331	N710000543	4.291,00 €
<b>SX2</b>		right droite	-	100096307	N710000489	3.797,00 €
			(2)	100096332	N710000639	4.546,00 €
		left gauche	-	100096308	N710000524	3.797,00 €
			(2)	100096333	N710000470	4.546,00 €
<b>SX3</b>		right droite	-	100096309	N710000468	4.909,00 €
			(2)	100096334	N710000464	6.029,00 €
		left gauche	-	100096310	N710000349	4.909,00 €
			(2)	100096335	N710000497	6.029,00 €
<b>SX4</b> <sup>(4)</sup>		right droite	-	100096311	N710000447	7.759,00 €
			(2)	100096336	N710000604	8.936,00 €
		left gauche	-	100096312	N710000659	7.759,00 €
			(2)	100096337	N710000629	8.936,00 €
<b>SX5</b> <sup>(4)</sup>		right droite	-	100096313	N710000583	5.596,00 €
			(2)	100096338	N710000514	6.346,00 €
		left gauche	-	100096314	N710000533	5.596,00 €
			(2)	100096339	N710000466	6.346,00 €



<sup>(1)</sup> Bath waste not included • *Vidage non inclus*

<sup>(2)</sup> Bath waste and overflow set included • *Vidage automatique inclus*





























<sup>(3)</sup> Bath waste and overflow set included with filler • *Vidage automatique avec bec verseur*

<sup>(4)</sup> Make sure that all the important equipment and LED lights can be easily accessed  
*Ne doit pas être encastrée sans possibilité d'accéder aux spots*

# SOLEIL SINGLE

bathtubs - baignoires

## ACCESSORIES • ACCESSOIRES

	DESCRIPTION DESCRIPTION	COLOUR COULEUR	SAP	KEA	€	BASIC	FRAME CHASSIS	S0	SX1	SX2	SX3	SX4	SX5
	<sup>(1)</sup> Bath waste and overflow set NEXT + Syphon • Vidage automatique NEXT + Syphon		100060498	N780000002	51,00 €	✓	✓	✓					
	<sup>(1)</sup> NEXT bath filler waste and overflow set including bath trap • Vidage NEXT avec bec verseur + Syphon		100060521	N780000008	130,00 €	✓	✓	✓					
	COLD head rest • Appui-tête COLD		100066186	N770000052	91,00 €	✓	✓	✓	✓	✓	✓	✓	✓
			100056383	N770000007	239,00 €								
	ENJOY head rest • Appui-tête ENJOY		100056384	N770000034	239,00 €	✓	✓	✓	✓	✓	✓	✓	✓
			100056387	N770000017	239,00 €								
	ENJOY "S" head rest • Appui-tête ENJOY "S"		100060780	N770000049	198,00 €								
			100060753	N770000065	198,00 €	✓	✓	✓	✓	✓	✓	✓	✓
			100060767	N770000057	198,00 €								
	<sup>(2)</sup> Set of CASUAL PLUS support frame with feet • Kit châssis universel CASUAL PLUS		100060499	N770000066	49,00 €	✓							
	<sup>(3)</sup> Bath access panel • Trappe de visite baignoire		250021559	N790001316	331,00 €	✓	✓	✓	✓	✓	✓	✓	✓
	MODUL panel 160 • 160 Tablier MODUL		100056215	N770000002	188,00 €		✓	✓	✓	✓	✓	✓	✓
	MODUL panel 70 • 70 tablier MODUL		100056218	N770000152	111,00 €		✓	✓	✓	✓	✓	✓	✓
			100056093	N770000121	331,00 €								
	CLUB panel 160 • 160 Tablier CLUB		100056095	N770000135	356,00 €		✓	✓	✓	✓	✓	✓	✓
			100056094	N770000138	384,00 €								
			100056075	N770000113	176,00 €								
	CLUB panel 70 • 70 Tablier CLUB		100056077	N770000132	191,00 €		✓	✓	✓	✓	✓	✓	✓
			100056076	N770000114	203,00 €								

<sup>(1)</sup> Only required for the models not including brassware • Nécessaire uniquement pour les modèles sans robinetterie

<sup>(2)</sup> Recommended use of 2 sets • On recommande 2 jeux pour ce modèle

<sup>(3)</sup> Required for all built-in installations • Nécessaire pour tous les modèles encastrés

# SOLEIL SINGLE

bathtubs - baignoires

## SOLEIL SINGLE 170x75 cm.

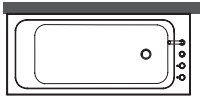

left  
gauche



right  
droite

Water volume 241 l.  
Volume d'eau 241 l.

		FINISH FINITION	BRASSWARE ROBINETTERIE	SAP	KEA	€
<b>BASIC</b>			(1)	100096496	N710000542	574,00 €
			(2)	100096505	N710000743	1.629,00 €
<b>BATH WITH FRAME CHASSIS SANS HYDROMAS- SAGE</b>			-	100096506	N710000532	1.127,00 €
			(2)	100096507	N710000548	2.250,00 €
<b>S0</b>		right droite	-	100096508	N710000530	2.340,00 €
			(2)	100096509	N710000684	3.428,00 €
		left gauche	-	100096510	N710000522	2.340,00 €
			(2)	100096511	N710000600	3.428,00 €
<b>SX1</b>		right droite	-	100096315	N710000633	3.397,00 €
			(2)	100096340	N710000539	4.313,00 €
		left gauche	-	100096341	N710000540	3.397,00 €
			(2)	100096342	N710000474	4.313,00 €
<b>SX2</b>		right droite	-	100096316	N710000547	3.820,00 €
			(2)	100096343	N710000476	4.569,00 €
		left gauche	-	100096344	N710000687	3.820,00 €
			(2)	100096345	N710000660	4.569,00 €
<b>SX3</b>		right droite	-	100096346	N710000511	4.931,00 €
			(2)	100096347	N710000483	6.052,00 €
		left gauche	-	100096348	N710000549	4.931,00 €
			(2)	100096349	N710000512	6.052,00 €
<b>SX4</b> (4)		right droite	-	100096350	N710000493	7.783,00 €
			(2)	100096351	N710000509	8.961,00 €
		left gauche	-	100096352	N710000653	7.783,00 €
			(2)	100096353	N710000473	8.961,00 €
<b>SX5</b> (4)		right droite	-	100096354	N710000537	5.620,00 €
			(2)	100096355	N710000414	6.369,00 €
		left gauche	-	100096356	N710000500	5.620,00 €
			(2)	100096357	N710000440	6.369,00 €



(1) Bath waste not included • Vidage non inclus

(2) Bath waste and overflow set included • Vidage automatique inclus

(3) Bath waste and overflow set included with filler • Vidage automatique avec bec verseur





























(4) Make sure that all the important equipment and LED lights can be easily accessed  
Ne doit pas être encastrée sans possibilité d'accéder aux spots



# SOLEIL SINGLE

bathtubs - baignoires

## ACCESSORIES • ACCESSOIRES

	DESCRIPTION DESCRIPTION	COLOUR COULEUR	SAP	KEA	€	BASIC	FRAME CHASSIS	S0	SX1	SX2	SX3	SX4	SX5
	<sup>(1)</sup> Bath waste and overflow set NEXT + Syphon • Vidage automatique NEXT + Syphon		100060498	N780000002	51,00 €	✓	✓	✓					
	<sup>(1)</sup> NEXT bath filler waste and overflow set including bath trap • Vidage NEXT avec bec verseur + Syphon		100060521	N780000008	130,00 €	✓	✓	✓					
	COLD head rest • Appui-tête COLD		100066186	N770000052	91,00 €	✓	✓	✓	✓	✓	✓	✓	✓
			100056383	N770000007	239,00 €								
	ENJOY head rest • Appui-tête ENJOY		100056384	N770000034	239,00 €	✓	✓	✓	✓	✓	✓	✓	✓
			100056387	N770000017	239,00 €								
	ENJOY "S" head rest • Appui-tête ENJOY "S"		100060780	N770000049	198,00 €								
			100060753	N770000065	198,00 €	✓	✓	✓	✓	✓	✓	✓	✓
			100060767	N770000057	198,00 €								
	<sup>(2)</sup> Set of CASUAL PLUS support frame with feet • Kit châssis universel CASUAL PLUS		100060499	N770000066	49,00 €	✓							
	<sup>(3)</sup> Bath access panel • Trappe de visite baignoire		250021559	N790001316	331,00 €	✓	✓	✓	✓	✓	✓	✓	✓
	MODUL panel 170 • 170 Tablier MODUL		100056216	N770000146	188,00 €		✓	✓	✓	✓	✓	✓	✓
	MODUL panel 75 • 75 tablier MODUL		100056217	N770000157	111,00 €		✓	✓	✓	✓	✓	✓	✓
			100056096	N770000144	341,00 €								
	CLUB panel 170 • 170 Tablier CLUB		100056098	N770000140	368,00 €		✓	✓	✓	✓	✓	✓	✓
			100056097	N770000145	398,00 €								
			100056078	N770000116	180,00 €								
	CLUB panel 75 • 75 Tablier CLUB		100056080	N770000120	192,00 €		✓	✓	✓	✓	✓	✓	✓
			100056079	N770000142	205,00 €								

<sup>(1)</sup> Only required for the models not including brassware • Nécessaire uniquement pour les modèles sans robinetterie

<sup>(2)</sup> Recommended use of 2 sets • On recommande 2 jeux pour ce modèle

<sup>(3)</sup> Required for all built-in installations • Nécessaire pour tous les modèles encastrés

# SOLEIL SINGLE

bathtubs - baignoires

## SOLEIL SINGLE 180x80 cm.

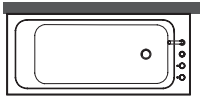

left  
gauche



right  
droite

Water volume 285 l.  
Volume d'eau 285 l.

		FINISH FINITION	BRASSWARE ROBINETTERIE	SAP	KEA	€
<b>BASIC</b>			(1)	100096497	N710000647	623,00 €
			(2)	100096512	N710000479	1.681,00 €
<b>BATH WITH FRAME CHASSIS SANS HYDROMAS- SAGE</b>			-	100096513	N710000610	1.231,00 €
			(2)	100096514	N710000545	2.305,00 €
<b>S0</b>		right droite	-	100096515	N710000622	2.367,00 €
			(2)	100096516	N710000831	3.459,00 €
		left gauche	-	100096517	N710000535	2.367,00 €
			(2)	100096518	N710000686	3.459,00 €
<b>SX1</b>		right droite	-	100096358	N710000518	3.459,00 €
			(2)	100096359	N710000517	4.379,00 €
		left gauche	-	100096360	N710000558	3.459,00 €
			(2)	100096361	N710000575	4.379,00 €
<b>SX2</b>		right droite	-	100096362	N710000480	3.888,00 €
			(2)	100096363	N710000555	4.638,00 €
		left gauche	-	100096364	N710000565	3.888,00 €
			(2)	100096365	N710000529	4.638,00 €
<b>SX3</b>		right droite	-	100096366	N710000538	4.993,00 €
			(2)	100096367	N710000668	6.119,00 €
		left gauche	-	100096368	N710000531	4.993,00 €
			(2)	100096369	N710000745	6.119,00 €
<b>SX4</b> <sup>(4)</sup>		right droite	-	100096370	N710000593	7.856,00 €
			(2)	100096371	N710000623	9.038,00 €
		left gauche	-	100096372	N710000627	7.856,00 €
			(2)	100096373	N710000577	9.038,00 €
<b>SX5</b> <sup>(4)</sup>		right droite	-	100096374	N710000674	5.688,00 €
			(2)	100096375	N710000546	6.437,00 €
		left gauche	-	100096376	N710000534	5.688,00 €
			(2)	100096377	N710000618	6.437,00 €



<sup>(1)</sup> Bath waste not included • *Vidage non inclus*

<sup>(2)</sup> Bath waste and overflow set included • *Vidage automatique inclus*





























<sup>(3)</sup> Bath waste and overflow set included with filler • *Vidage automatique avec bec verseur*

<sup>(4)</sup> Make sure that all the important equipment and LED lights can be easily accessed  
*Ne doit pas être encastrée sans possibilité d'accéder aux spots*

# SOLEIL SINGLE

bathtubs - baignoires

## ACCESSORIES • ACCESSOIRES

	DESCRIPTION DESCRIPTION	COLOUR COULEUR	SAP	KEA	€	BASIC	FRAME CHASSIS	S0	SX1	SX2	SX3	SX4	SX5
	<sup>(1)</sup> Bath waste and overflow set NEXT + Syphon • Vidage automatique NEXT + Syphon		100060498	N780000002	51,00 €	✓	✓	✓					
	<sup>(1)</sup> NEXT bath filler waste and overflow set including bath trap • Vidage NEXT avec bec verseur + Syphon		100060521	N780000008	130,00 €	✓	✓	✓					
	COLD head rest • Appui-tête COLD		100066186	N770000052	91,00 €	✓	✓	✓	✓	✓	✓	✓	✓
			100056383	N770000007	239,00 €								
	ENJOY head rest • Appui-tête ENJOY		100056384	N770000034	239,00 €	✓	✓	✓	✓	✓	✓	✓	✓
			100056387	N770000017	239,00 €								
	ENJOY "S" head rest • Appui-tête ENJOY "S"		100060780	N770000049	198,00 €								
			100060753	N770000065	198,00 €	✓	✓	✓	✓	✓	✓	✓	✓
			100060767	N770000057	198,00 €								
	<sup>(2)</sup> Set of CASUAL PLUS support frame with feet • Kit châssis universel CASUAL PLUS		100060499	N770000066	49,00 €	✓							
	<sup>(3)</sup> Bath access panel • Trappe de visite baignoire		250021559	N790001316	331,00 €	✓	✓	✓	✓	✓	✓	✓	✓
	MODUL panel 180 • 180 Tablier MODUL		100056222	N770000153	220,00 €		✓	✓	✓	✓	✓	✓	✓
	MODUL panel 80 • 80 tablier MODUL		100056219	N770000150	111,00 €		✓	✓	✓	✓	✓	✓	✓
			100056099	N770000130	354,00 €								
	CLUB panel 180 • 180 Tablier CLUB		100056101	N770000133	383,00 €		✓	✓	✓	✓	✓	✓	✓
			100056100	N770000118	414,00 €								
			100056081	N770000117	184,00 €								
	CLUB panel 80 • 80 Tablier CLUB		100056083	N770000136	196,00 €		✓	✓	✓	✓	✓	✓	✓
			100056082	N770000124	211,00 €								

<sup>(1)</sup> Only required for the models not including brassware • Nécessaire uniquement pour les modèles sans robinetterie

<sup>(2)</sup> Recommended use of 2 sets • On recommande 2 jeux pour ce modèle

<sup>(3)</sup> Required for all built-in installations • Nécessaire pour tous les modèles encastrés

# MINIMAL

bathtubs - baignoires



bathtubs / baignoires MINIMAL

## COLOURS • COULEURS



CLUB panel  
tablier CLUB



white  
blanc



black  
noir



Inox



MODUL panel  
tablier MODUL



white  
blanc



chrome / white  
chromé / blanc



Chrome  
Chromé

## ACCESSORIES • ACCESSOIRES



ENJOY head rest  
Appui-tête ENJOY



ENJOY "S" head rest  
Appui-tête ENJOY "S"



COLD head rest  
appui-tête COLD

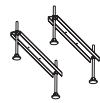

Set of universal support  
frame with feet CASUAL  
châssis universel  
CASUAL



CLUB panel  
tablier CLUB



MODUL panel  
tablier MODUL



access panel  
trappe de visite



bath waste and  
overflow set  
vidage automatique



bath filler waste and  
overflow set  
automatique vidage bec  
verseur



deck mounted valves and  
handset  
robinetterie

## SIZES cm. • FORMATS cm.

150x70 • 61h  
 160x70 • 61h  
 160x75 • 61h

## EQUIPMENT • EQUIPEMENT

		S0	SX1	SX2	SX3	SX4	SX5
JETS		6	-	8	8	8	-
BLOWERS		-	8	-	8	8	8
CHROMOTHERAPY CHROMOTHERAPIE		-	-	-	-	8	8
DISINFECTION DÉSINFECTION		-	-	-	-	✓	-

See features on page 22-25.  
 Consultez caracteristiques en page 22-25.

## DRAWINGS mm. • PLANS mm.

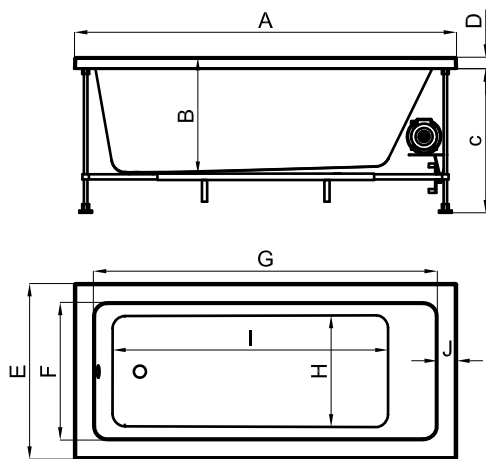

mm	A	B	C	D	E	F	G	H	I	J
1500 x 700	1500	450	565	45	700	540	1340	440	1070	80
1600 x 700	1600	450	565	45	700	540	1440	440	1170	80
1600 x 750	1600	450	565	45	750	590	1440	490	1170	80

## PRE-INSTALLING • PRE-INSTALLATION

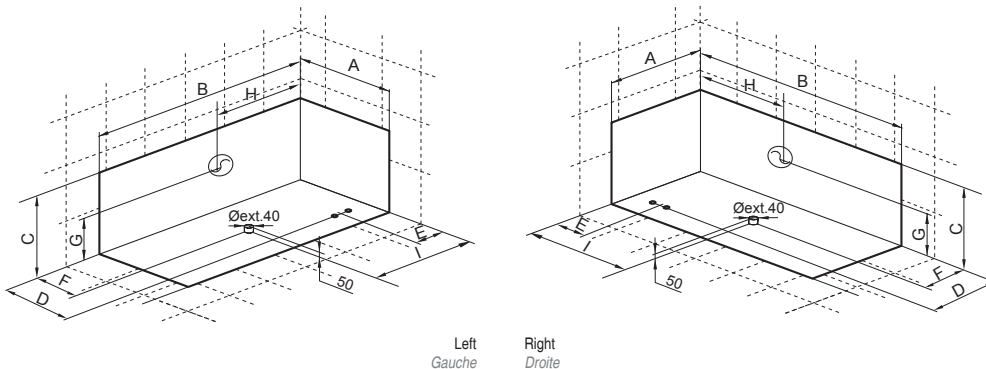

	Hot water connections Prise d'eau chaude
	Cold water connections Prise d'eau froide
	Waste Vidage
	Electrical connections Câblage électrique

mm	A	B	C	D	E	F	G	H	I
1500 x 700	700	1500	610	465	250	350	300	750	350
1600 x 700	700	1600	610	465	250	350	300	800	400
1600 x 750	750	1600	610	500	250	375	300	800	400

## PACKAGING DETAILS • DONNÉES D'EXPÉDITION

		DIMENSIONS DIMENSIONS		VOLUME VOLUME	NET WEIGHT / PIECE POIDS NET / PIÈCE	GROSS WEIGHT / PALLET POIDS BRUT / PALETTE	PIECES / PALLET PIÈCES / PALETTE
150x70	BASIC	L W H	120 cm 80 cm 170 cm	1,63 m <sup>3</sup>	24,3 Kg	229,4 Kg	8
	BATH WITH FRAME CHASSIS SANS HYDROMAS- SAGE	L W H	154 cm 74 cm 69 cm	0,79 m <sup>3</sup>	33,6 Kg	38,7 Kg	1
	S0	L W H	154 cm 74 cm 69 cm	0,79 m <sup>3</sup>	45,9 Kg	51 Kg	1
	SX1	L W H	154 cm 74 cm 69 cm	0,79 m <sup>3</sup>	39,9 Kg	45 Kg	1
	SX2	L W H	154 cm 74 cm 69 cm	0,79 m <sup>3</sup>	45,4 Kg	50,5 Kg	1
	SX3	L W H	154 cm 74 cm 69 cm	0,79 m <sup>3</sup>	51,7 Kg	56,8 Kg	1
	SX4	L W H	154 cm 74 cm 69 cm	0,79 m <sup>3</sup>	54,7 Kg	59,8 Kg	1
	SX5	L W H	154 cm 74 cm 69 cm	0,79 m <sup>3</sup>	40,9 Kg	46 Kg	1
160x70	BASIC	L W H	102 cm 80 cm 180 cm	1,73 m <sup>3</sup>	26,2 Kg	244,6 Kg	8
	BATH WITH FRAME CHASSIS SANS HYDROMAS- SAGE	L W H	164 cm 79 cm 69 cm	0,89 m <sup>3</sup>	32,9 Kg	38,9 Kg	1
	S0	L W H	164 cm 79 cm 69 cm	0,89 m <sup>3</sup>	48,5 Kg	54,5 Kg	1
	SX1	L W H	164 cm 79 cm 69 cm	0,89 m <sup>3</sup>	42,5 Kg	48,5 Kg	1
	SX2	L W H	164 cm 79 cm 69 cm	0,89 m <sup>3</sup>	48 Kg	54 Kg	1
	SX3	L W H	164 cm 79 cm 69 cm	0,89 m <sup>3</sup>	57,6 Kg	63,6 Kg	1
	SX4	L W H	162 cm 72 cm 45 cm	0,89 m <sup>3</sup>	60,6 Kg	66,6 Kg	1
	SX5	L W H	164 cm 79 cm 69 cm	0,89 m <sup>3</sup>	43,5 Kg	49,5 Kg	1

## PACKAGING DETAILS • DONNÉES D'EXPÉDITION

		DIMENSIONS DIMENSIONS		VOLUME VOLUME	NET WEIGHT / PIECE POIDS NET / PIÈCE	GROSS WEIGHT / PALLET POIDS BRUT / PALETTE	PIECES / PALLET PIÈCES / PALETTE
160x75	BASIC	L W H	120 cm 85 cm 180 cm	1,84 m <sup>3</sup>	26,8 Kg	249,4 Kg	8
	BATH WITH FRAME CHASSIS SANS HYDROMASSAGE	L W H	164 cm 79 cm 69 cm	0,89 m <sup>3</sup>	35,5 Kg	41,5 Kg	1
	S0	L W H	164 cm 79 cm 69 cm	0,89 m <sup>3</sup>	52 Kg	58 Kg	1
	SX1	L W H	164 cm 79 cm 69 cm	0,89 m <sup>3</sup>	46 Kg	52 Kg	1
	SX2	L W H	164 cm 79 cm 69 cm	0,89 m <sup>3</sup>	51,5 Kg	57,5 Kg	1
	SX3	L W H	164 cm 79 cm 69 cm	0,89 m <sup>3</sup>	62 Kg	68 Kg	1
	SX4	L W H	164 cm 79 cm 69 cm	0,89 m <sup>3</sup>	65 Kg	71 Kg	1
	SX5	L W H	164 cm 79 cm 69 cm	0,89 m <sup>3</sup>	47 Kg	53 Kg	1

## MINIMAL 150x70 cm.

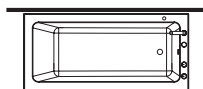



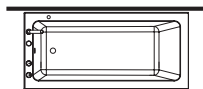





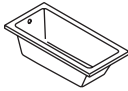

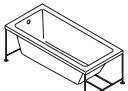











left  
gauche



right  
droite

Water volume 185 l.  
Volume d'eau 185 l.

		FINISH FINITION	BRASSWARE ROBINETTERIE	SAP	KEA	€	
<b>BASIC</b>		(1)		100050790	N710000067	496,00 €	
		(3)		100050791	N710000076	1.499,00 €	
<b>BATH WITH FRAME CHASSIS SANS HYDROMAS- SAGE</b>		(1)		100050792	N710000110	969,00 €	
		(3)		100050793	N710000057	1.990,00 €	
<b>S0</b>		right droite	(1)	100050794	N710000055	2.161,00 €	
		left gauche	(3)		100050795	N710000053	3.190,00 €
			(1)	100050804	N710000072	2.161,00 €	
		(3)		100050805	N710000061	3.190,00 €	
<b>SX1</b>		right droite	(2)	100102420	N710000732	2.790,00 €	
		left gauche	(3)		100102421	N710000584	3.865,00 €
			(2)	100102422	N710000699	2.790,00 €	
		(3)		100102423	N710000650	3.865,00 €	
<b>SX2</b>		right droite	(2)	100102424	N710000591	3.312,00 €	
		left gauche	(3)		100102425	N710000665	4.151,00 €
			(2)	100102426	N710000501	3.312,00 €	
		(3)		100102427	N710000617	4.151,00 €	
<b>SX3</b>		right droite	(2)	100102428	N710000651	4.434,00 €	
		left gauche	(3)		100102429	N710000608	5.509,00 €
			(2)	100102430	N710000707	4.434,00 €	
		(3)		100102431	N710000694	5.509,00 €	
<b>SX4</b> <sup>(4)</sup>		right droite	(2)	100102432	N710000587	7.092,00 €	
		left gauche	(3)		100102433	N710000706	8.167,00 €
			(2)	100102434	N710000594	7.092,00 €	
		(3)		100102435	N710000589	8.167,00 €	
<b>SX5</b> <sup>(4)</sup>		right droite	(2)	100102436	N710000740	4.986,00 €	
		left gauche	(3)		100102437	N710000559	5.826,00 €
			(2)	100102438	N710000630	4.986,00 €	
		(3)		100102439	N710000644	5.826,00 €	



<sup>(1)</sup> Bath waste not included • Vidage non inclus





























<sup>(2)</sup> Waste included • Vidage inclus

<sup>(3)</sup> Bath waste and overflow set included with filler • Vidage automatique avec bec verseur

<sup>(4)</sup> Make sure that all the important equipment and LED lights can be easily accessed  
Ne doit pas être encastrée sans possibilité d'accéder aux spots



## ACCESSORIES • ACCESSOIRES

	DESCRIPTION DESCRIPTION	COLOUR COULEUR	SAP	KEA	€	BASIC	FRAME CHASSIS	S0	SX1	SX2	SX3	SX4	SX5
	<sup>(1)</sup> Bath waste and overflow set NEXT + Syphon • Vidage automatique NEXT + Syphon		100060498	N780000002	51,00 €	✓	✓	✓					
	<sup>(1)</sup> NEXT bath filler waste and overflow set including bath trap • Vidage NEXT avec bec verseur + Syphon		100060521	N780000008	130,00 €	✓	✓	✓					
	COLD head rest • Appui-tête COLD		100066186	N770000052	91,00 €	✓	✓	✓	✓	✓	✓	✓	✓
			100056383	N770000007	239,00 €								
	ENJOY head rest • Appui-tête ENJOY		100056384	N770000034	239,00 €	✓	✓	✓	✓	✓	✓	✓	✓
			100056387	N770000017	239,00 €								
	ENJOY "S" head rest • Appui-tête ENJOY "S"		100060780	N770000049	198,00 €								
			100060753	N770000065	198,00 €	✓	✓	✓	✓	✓	✓	✓	✓
			100060767	N770000057	198,00 €								
	<sup>(2)</sup> Set of CASUAL PLUS support frame with feet • Kit châssis universel CASUAL PLUS		100057508	N770000042	39,00 €	✓							
	<sup>(3)</sup> Bath access panel • Trappe de visite baignoire		250021559	N790001316	331,00 €	✓	✓	✓	✓	✓	✓	✓	✓
	MODUL panel 150 • 150 Tablier MODUL		100056221	N770000156	188,00 €		✓	✓	✓	✓	✓	✓	✓
	MODUL panel 70 • 70 tablier MODUL		100056218	N770000152	111,00 €		✓	✓	✓	✓	✓	✓	✓
			100056090	N770000139	326,00 €								
	CLUB panel 150 • 150 Tablier CLUB		100056092	N770000143	350,00 €		✓	✓	✓	✓	✓	✓	✓
			100056091	N770000128	375,00 €								
			100056075	N770000113	176,00 €								
	CLUB panel 70 • 70 Tablier CLUB		100056077	N770000132	191,00 €		✓	✓	✓	✓	✓	✓	✓
			100056076	N770000114	203,00 €								

<sup>(1)</sup> Only required for the models not including brassware • Nécessaire uniquement pour les modèles sans robinetterie

<sup>(2)</sup> Recommended use of 2 sets • On recommande 2 jeux pour ce modèle

<sup>(3)</sup> Required for all built-in installations • Nécessaire pour tous les modèles encastrés

## MINIMAL 160x70 cm.

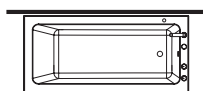









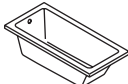

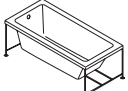











left  
gauche



right  
droite

Water volume 199 l.  
Volume d'eau 199 l.

		FINISH FINITION	BRASSWARE ROBINETTERIE	SAP	KEA	€	
<b>BASIC</b>		(1)		100050814	N710000058	503,00 €	
		(3)		100050815	N710000083	1.505,00 €	
<b>BATH WITH FRAME CHASSIS SANS HYDROMAS- SAGE</b>		(1)		100050816	N710000070	976,00 €	
		(3)		100050817	N710000052	1.998,00 €	
<b>S0</b>		right droite	(1)	100050818	N710000081	2.169,00 €	
		left gauche	(3)		100050819	N710000087	3.198,00 €
			(1)	100050828	N710000101	2.169,00 €	
		(3)		100050829	N710000059	3.198,00 €	
<b>SX1</b>		right droite	(2)	100102440	N710000703	2.798,00 €	
		left gauche	(3)		100102441	N710000751	3.873,00 €
			(2)	100102442	N710000597	2.798,00 €	
		(3)		100102443	N710000701	3.873,00 €	
<b>SX2</b>		right droite	(2)	100102444	N710000821	3.321,00 €	
		left gauche	(3)		100102445	N710000581	4.162,00 €
			(2)	100102446	N710000642	3.321,00 €	
		(3)		100102447	N710000763	4.162,00 €	
<b>SX3</b>		right droite	(2)	100102448	N710000683	4.441,00 €	
		left gauche	(3)		100102449	N710000702	5.516,00 €
			(2)	100102450	N710000692	4.441,00 €	
		(3)		100102451	N710000544	5.516,00 €	
<b>SX4</b> <sup>(4)</sup>		right droite	(2)	100102452	N710000795	7.099,00 €	
		left gauche	(3)		100102453	N710000636	8.175,00 €
			(2)	100102454	N710000603	7.099,00 €	
		(3)		100102455	N710000588	8.175,00 €	
<b>SX5</b> <sup>(4)</sup>		right droite	(2)	100102456	N710000761	4.996,00 €	
		left gauche	(3)		100102457	N710000552	5.836,00 €
			(2)	100102458	N710000557	4.996,00 €	
		(3)		100102459	N710000605	5.836,00 €	































<sup>(1)</sup> Bath waste not included • Vidage non inclus

<sup>(2)</sup> Waste included • Vidage inclus

<sup>(3)</sup> Bath waste and overflow set included with filler • Vidage automatique avec bec verseur

<sup>(4)</sup> Make sure that all the important equipment and LED lights can be easily accessed  
Ne doit pas être encastrée sans possibilité d'accéder aux spots

## ACCESSORIES • ACCESSOIRES

	DESCRIPTION DESCRIPTION	COLOUR COULEUR	SAP	KEA	€	BASIC	FRAME CHASSIS	S0	SX1	SX2	SX3	SX4	SX5
	<sup>(1)</sup> Bath waste and overflow set NEXT + Syphon • Vidage automatique NEXT + Syphon		100060498	N780000002	51,00 €	✓	✓	✓					
	<sup>(1)</sup> NEXT bath filler waste and overflow set including bath trap • Vidage NEXT avec bec verseur + Syphon		100060521	N780000008	130,00 €	✓	✓	✓					
	COLD head rest • Appui-tête COLD		100066186	N770000052	91,00 €	✓	✓	✓	✓	✓	✓	✓	✓
			100056383	N770000007	239,00 €								
	ENJOY head rest • Appui-tête ENJOY		100056384	N770000034	239,00 €	✓	✓	✓	✓	✓	✓	✓	✓
			100056387	N770000017	239,00 €								
	ENJOY "S" head rest • Appui-tête ENJOY "S"		100060780	N770000049	198,00 €								
			100060753	N770000065	198,00 €	✓	✓	✓	✓	✓	✓	✓	✓
			100060767	N770000057	198,00 €								
	<sup>(2)</sup> Set of CASUAL PLUS support frame with feet • Kit châssis universel CASUAL PLUS		100057508	N770000042	39,00 €	✓							
	<sup>(3)</sup> Bath access panel • Trappe de visite baignoire		250021559	N790001316	331,00 €	✓	✓	✓	✓	✓	✓	✓	✓
	MODUL panel 160 • 160 Tablier MODUL		100056215	N770000002	188,00 €		✓	✓	✓	✓	✓	✓	✓
	MODUL panel 70 • 70 tablier MODUL		100056218	N770000152	111,00 €		✓	✓	✓	✓	✓	✓	✓
			100056093	N770000121	331,00 €								
	CLUB panel 160 • 160 Tablier CLUB		100056095	N770000135	356,00 €		✓	✓	✓	✓	✓	✓	✓
			100056094	N770000138	384,00 €								
			100056075	N770000113	176,00 €								
	CLUB panel 70 • 70 Tablier CLUB		100056077	N770000132	191,00 €		✓	✓	✓	✓	✓	✓	✓
			100056076	N770000114	203,00 €								

<sup>(1)</sup> Only required for the models not including brassware • Nécessaire uniquement pour les modèles sans robinetterie

<sup>(2)</sup> Recommended use of 2 sets • On recommande 2 jeux pour ce modèle

<sup>(3)</sup> Required for all built-in installations • Nécessaire pour tous les modèles encastrés

## MINIMAL 160x75 cm.

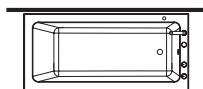

left  
gauche



right  
droite

Water volume 221 l.  
Volume d'eau 221 l.

		FINISH FINITION	BRASSWARE ROBINETTERIE	SAP	KEA	€
<b>BASIC</b>		(1)		100050838	N710000080	536,00 €
		(3)		100050839	N710000086	1.538,00 €
<b>BATH WITH FRAME CHASSIS SANS HYDROMAS- SAGE</b>		(1)		100050840	N710000084	1.013,00 €
		(3)		100050841	N710000068	2.034,00 €
<b>S0</b>		right droite	(1)	100050842	N710000119	2.204,00 €
			(3)		100050843	N710000085
		left gauche	(1)	100050852	N710000056	2.204,00 €
			(3)		100050853	N710000073
<b>SX1</b>		right droite	(2)	100102460	N710000791	2.835,00 €
			(3)		100102461	N710000685
		left gauche	(2)	100102462	N710000596	2.835,00 €
			(3)		100102463	N710000553
<b>SX2</b>		right droite	(2)	100102464	N710000609	3.352,00 €
			(3)		100102465	N710000560
		left gauche	(2)	100102466	N710000590	3.352,00 €
			(3)		100102467	N710000722
<b>SX3</b>		right droite	(2)	100102468	N710000752	4.478,00 €
			(3)		100102469	N710000664
		left gauche	(2)	100102470	N710000720	4.478,00 €
			(3)		100102471	N710000599
<b>SX4</b> <sup>(4)</sup>		right droite	(2)	100102472	N710000679	7.136,00 €
			(3)		100102473	N710000655
		left gauche	(2)	100102474	N710000747	7.136,00 €
			(3)		100102475	N710000759
<b>SX5</b> <sup>(4)</sup>		right droite	(2)	100102476	N710000691	5.027,00 €
			(3)		100102477	N710000744
		left gauche	(2)	100102478	N710000675	5.027,00 €
			(3)		100102479	N710000695































<sup>(1)</sup> Bath waste not included • Vidage non inclus

<sup>(2)</sup> Waste included • Vidage inclus

<sup>(3)</sup> Bath waste and overflow set included with filler • Vidage automatique avec bec verseur

<sup>(4)</sup> Make sure that all the important equipment and LED lights can be easily accessed  
Ne doit pas être encastrée sans possibilité d'accéder aux spots

## ACCESSORIES • ACCESSOIRES

	DESCRIPTION DESCRIPTION	COLOUR COULEUR	SAP	KEA	€	BASIC	FRAME CHASSIS	S0	SX1	SX2	SX3	SX4	SX5
	<sup>(1)</sup> Bath waste and overflow set NEXT + Syphon • Vidage automatique NEXT + Syphon		100060498	N780000002	51,00 €	✓	✓	✓					
	<sup>(1)</sup> NEXT bath filler waste and overflow set including bath trap • Vidage NEXT avec bec verseur + Syphon		100060521	N780000008	130,00 €	✓	✓	✓					
	COLD head rest • Appui-tête COLD		100066186	N770000052	91,00 €	✓	✓	✓	✓	✓	✓	✓	✓
			100056383	N770000007	239,00 €								
	ENJOY head rest • Appui-tête ENJOY		100056384	N770000034	239,00 €	✓	✓	✓	✓	✓	✓	✓	✓
			100056387	N770000017	239,00 €								
	ENJOY "S" head rest • Appui-tête ENJOY "S"		100060780	N770000049	198,00 €								
			100060753	N770000065	198,00 €	✓	✓	✓	✓	✓	✓	✓	✓
			100060767	N770000057	198,00 €								
	<sup>(2)</sup> Set of CASUAL PLUS support frame with feet • Kit châssis universel CASUAL PLUS		100057508	N770000042	39,00 €	✓							
	<sup>(3)</sup> Bath access panel • Trappe de visite baignoire		250021559	N790001316	331,00 €	✓	✓	✓	✓	✓	✓	✓	✓
	MODUL panel 160 • 160 Tablier MODUL		100056215	N770000002	188,00 €		✓	✓	✓	✓	✓	✓	✓
	MODUL panel 75 • 75 tablier MODUL		100056217	N770000157	111,00 €		✓	✓	✓	✓	✓	✓	✓
			100056093	N770000121	331,00 €								
	CLUB panel 160 • 160 Tablier CLUB		100056095	N770000135	356,00 €		✓	✓	✓	✓	✓	✓	✓
			100056094	N770000138	384,00 €								
			100056078	N770000116	180,00 €								
	CLUB panel 75 • 75 Tablier CLUB		100056080	N770000120	192,00 €		✓	✓	✓	✓	✓	✓	✓
			100056079	N770000142	205,00 €								

<sup>(1)</sup> Only required for the models not including brassware • Nécessaire uniquement pour les modèles sans robinetterie

<sup>(2)</sup> Recommended use of 2 sets • On recommande 2 jeux pour ce modèle

<sup>(3)</sup> Required for all built-in installations • Nécessaire pour tous les modèles encastrés

# MINIMAL XL

bathtubs - baignoires



bathtubs / baignoires MINIMAL XL

## COLOURS • COULEURS



CLUB panel  
tablier CLUB



white  
blanc



black  
noir



Inox



MODUL panel  
tablier MODUL



white  
blanc



chrome / white  
chromé / blanc



Chrome  
Chromé

## ACCESSORIES • ACCESSOIRES



ENJOY head rest  
Appui-tête ENJOY



ENJOY "S" head rest  
Appui-tête ENJOY "S"



COLD head rest  
appui-tête COLD

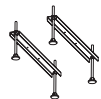

Set of universal support  
frame with feet CASUAL  
châssis universel  
CASUAL



CLUB panel  
tablier CLUB



MODUL panel  
tablier MODUL



access panel  
trappe de visite



bath waste and  
overflow set  
vidage automatique



bath filler waste and over-  
flow set  
automatique vidage bec  
verseur



deck mounted valves and  
handset  
robinetterie

# MINIMAL XL

bathtubs - baignoires

## SIZES cm. • FORMATS cm.

170 x 70 • 61h  
 170 x 75 • 61h  
 170 x 80 • 61h  
 180 x 80 • 61h  
 190 x 90 • 61h

## EQUIPMENT • EQUIPEMENT

		S0	SX1	SX2	SX3	SX4	SX5
JETS		6	-	10	10	10	-
BLOWERS		-	9	-	9	9	9
CHROMOTHERAPY CHROMOTHERAPIE		-	-	-	-	10	10
DISINFECTION DÉSINFECTION		-	-	-	-	✓	-

See features on page 22-25.

Consultez caractéristiques en page 22-25.

## DRAWINGS mm. • PLANS mm.

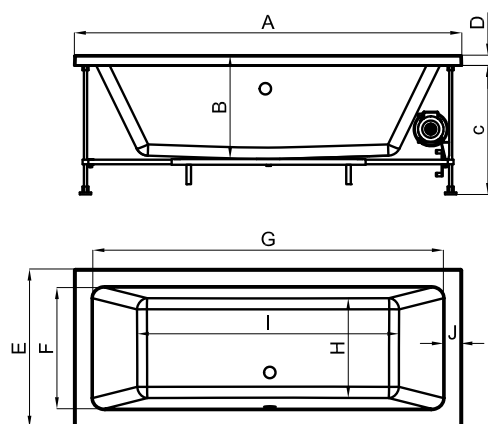

mm	A	B	C	D	E	F	G	H	I	J
1700 x 700	1700	450	565	45	700	540	1540	440	1140	80
1700 x 750	1700	470	565	45	750	600	1540	490	1140	80
1700 x 800	1700	470	565	45	800	640	1540	540	1140	80
1800 x 800	1800	470	565	45	800	640	1640	540	1240	80
1900 x 900	1900	470	565	45	900	740	1740	640	1340	80

## PRE-INSTALLING • PRE-INSTALLATION

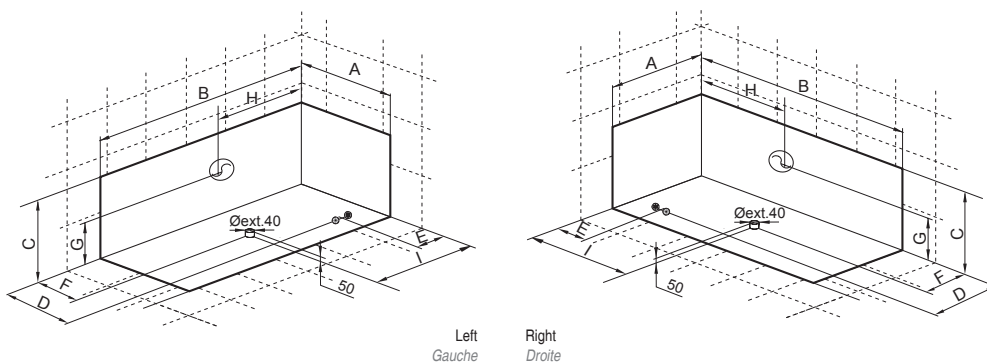

	Hot water connections Prise d'eau chaude
	Cold water connections Prise d'eau froide
	Waste Vidage
	Electrical connections Câblage électrique

mm	A	B	C	D	E	F	G	H	I
1700 x 700	700	1700	610	465	250	350	300	850	850
1700 x 750	750	1700	610	500	250	375	300	850	850
1700 x 800	800	1700	610	535	250	400	300	850	850
1800 x 800	800	1800	610	535	250	400	300	900	900
1900 x 900	900	1900	610	600	250	450	300	950	950

## PACKAGING DETAILS • DONNÉES D'EXPÉDITION

		DIMENSIONS DIMENSIONS		VOLUME VOLUME	NET WEIGHT / PIECE POIDS NET / PIECE	GROSS WEIGHT / PALLET POIDS BRUT / PALETTE	PIECES / PALLET PIECES / PALETTE								
170x70	BASIC	L	120 cm	1,83 m <sup>3</sup>	26,3 Kg	245,4 Kg	8								
		W	80 cm												
		H	190 cm												
	BATH WITH FRAME CHASSIS SANS HYDROMAS- SAGE	L	174 cm					0,95 m <sup>3</sup>	36,5 Kg	43,5 Kg	1				
		W	79cm												
		H	69 cm												
	S0	L	174 cm									0,95 m <sup>3</sup>	46,4 Kg	53,4 Kg	1
		W	79 cm												
	H	69 cm													
SX1	L	174 cm	0,95 m <sup>3</sup>	42,4 Kg	49,4 Kg	1									
	W	79cm													
	H	69 cm													
SX2	L	174 cm					0,95 m <sup>3</sup>	49,2 Kg	56,2 Kg	1					
	W	79 cm													
	H	69 cm													
SX3	L	174 cm									0,95 m <sup>3</sup>	55 Kg	62 Kg	1	
	W	79 cm													
	H	69 cm													
SX4	L	174 cm	0,95 m <sup>3</sup>	58 Kg	65 Kg	1									
	W	79 cm													
	H	69 cm													
SX5	L	174 cm					0,95 m <sup>3</sup>	43,4 Kg	50,4 Kg	1					
	W	79 cm													
	H	69 cm													
170x75	BASIC	L									120 cm	1,94 m <sup>3</sup>	28,0 Kg	259 Kg	8
		W									85 cm				
		H	190 cm												
	BATH WITH FRAME CHASSIS SANS HYDROMAS- SAGE	L	174 cm	0,95 m <sup>3</sup>	38,6 Kg	45,6 Kg					1				
		W	79 cm												
		H	69 cm												
	S0	L	174 cm				0,95 m <sup>3</sup>	48,5 Kg	55,5 Kg	1					
		W	79 cm												
	H	69 cm													
SX1	L	174 cm	0,95 m <sup>3</sup>									44,5 Kg	51,5 Kg	1	
	W	79 cm													
	H	69 cm													
SX2	L	174 cm		0,95 m <sup>3</sup>	51,3 Kg	58,3 Kg					1				
	W	79 cm													
	H	69 cm													
SX3	L	174 cm					0,95 m <sup>3</sup>	57,5 Kg	64,5 Kg	1					
	W	79 cm													
	H	69 cm													
SX4	L	174 cm	0,95 m <sup>3</sup>									60,5 Kg	67,5 Kg	1	
	W	79 cm													
	H	69 cm													
SX5	L	174 cm		0,95 m <sup>3</sup>	45,5 Kg	52,5 Kg					1				
	W	79 cm													
	H	69 cm													
170x80	BASIC	L					120 cm	2,1 m <sup>3</sup>	30,3 Kg	277,4 Kg					8
		W					90 cm								
		H	190 cm												
	BATH WITH FRAME CHASSIS SANS HYDROMAS- SAGE	L	184 cm				1,07 m <sup>3</sup>					40,3 Kg	47,8 Kg	1	
		W	84 cm												
		H	69 cm												
	S0	L	184 cm	1,07 m <sup>3</sup>	50,1 Kg	57,6 Kg					1				
		W	84 cm												
	H	69 cm													
SX1	L	184 cm	1,07 m <sup>3</sup>					46,1 Kg	53,6 Kg	1					
	W	84 cm													
	H	69 cm													
SX2	L	184 cm					1,07 m <sup>3</sup>					53 Kg	60,5 Kg	1	
	W	84 cm													
	H	69 cm													
SX3	L	184 cm		1,07 m <sup>3</sup>	52 Kg	59,5 Kg					1				
	W	84 cm													
	H	69 cm													
SX4	L	184 cm	1,07 m <sup>3</sup>					55 Kg	62,5 Kg	1					
	W	84 cm													
	H	69 cm													
SX5	L	184 cm					1,07 m <sup>3</sup>					47,1 Kg	54,6 Kg	1	
	W	84 cm													
	H	69 cm													



## PACKAGING DETAILS • DONNÉES D'EXPÉDITION

		DIMENSIONS DIMENSIONS		VOLUME VOLUME	NET WEIGHT / PIECE POIDS NET / PIECE	GROSS WEIGHT / PALLET POIDS BRUT / PALETTE	PIECES / PALLET PIECES / PALETTE
180x80	BASIC	L W H	120 cm 90 cm 200 cm	2,2 m <sup>3</sup>	31,3 Kg	285,4 Kg	8
	BATH WITH FRAME CHASSIS SANS HYDROMASSAGE	L W H	184 cm 84 cm 69 cm	1,07 m <sup>3</sup>	42,4 Kg	49,9 Kg	1
	S0	L W H	184 cm 84 cm 69 cm	1,07 m <sup>3</sup>	52,2 Kg	59,7 Kg	1
	SX1	L W H	184 cm 84 cm 69 cm	1,07 m <sup>3</sup>	48,2 Kg	55,7 Kg	1
	SX2	L W H	184 cm 84 cm 69 cm	1,07 m <sup>3</sup>	55,1 Kg	62,6 Kg	1
	SX3	L W H	184 cm 84 cm 69 cm	1,07 m <sup>3</sup>	55,5 Kg	63 Kg	1
	SX4	L W H	184 cm 84 cm 69 cm	1,07 m <sup>3</sup>	58,5 Kg	66 Kg	1
	SX5	L W H	184 cm 84 cm 69 cm	1,07 m <sup>3</sup>	49,2 Kg	56,7 Kg	1
190x90	BASIC	L W H	120 cm 100 cm 210 cm	2,52 m <sup>3</sup>	37,7 Kg	336,6 Kg	8
	BATH WITH FRAME CHASSIS SANS HYDROMASSAGE	L W H	194 cm 94 cm 69cm	1,26 m <sup>3</sup>	44,4 Kg	52,0 Kg	1
	S0	L W H	194 cm 94 cm 69cm	1,26 m <sup>3</sup>	54,3 Kg	61,9 Kg	1
	SX1	L W H	194 cm 94 cm 69cm	1,26 m <sup>3</sup>	50,3 Kg	57,9 Kg	1
	SX2	L W H	194 cm 94 cm 69cm	1,26 m <sup>3</sup>	57,1 Kg	64,7 Kg	1
	SX3	L W H	194 cm 94 cm 69cm	1,26 m <sup>3</sup>	65,9 Kg	73,5 Kg	1
	SX4	L W H	194 cm 94 cm 69cm	1,26 m <sup>3</sup>	68,9 Kg	76,5 Kg	1
	SX5	L W H	194 cm 94 cm 69cm	1,26 m <sup>3</sup>	51,3 Kg	58,9 Kg	1

## MINIMAL XL 170x70 cm.

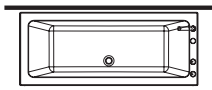
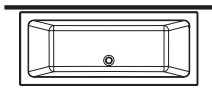

left  
gauche

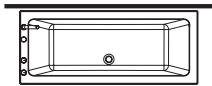

right  
droite

Water volume 196 l.  
Volume d'eau 196 l.



- <sup>(1)</sup> Bath waste not included  
*Vidage non inclus*
- <sup>(2)</sup> Waste included  
*Vidage inclus*
- <sup>(3)</sup> Bath waste and overflow set included with filler  
*Vidage automatique avec bec verseur*
- <sup>(4)</sup> Make sure that all the important equipment and LED lights can be easily accessed  
*Ne doit pas être encastrée sans possibilité d'accéder aux spots*

		FINISH FINITION	BRASSWARE ROBINETTERIE	SAP	KEA	€
<b>BASIC</b>			(1)	100050862	N710000098	536,00 €
		(3)		100050863	N710000104	1.538,00 €
<b>BATH WITH FRAME CHASSIS SANS HYDROMASSAGE</b>			(1)	100050864	N710000062	1.013,00 €
		(3)		100050865	N710000077	2.034,00 €
<b>S0</b>		right droite	(1)	100050866	N710000065	2.204,00 €
		left gauche	(3)	100050867	N710000107	3.234,00 €
<b>SX1</b>		right droite	(2)	100102480	N710000748	3.105,00 €
		left gauche	(3)	100102481	N710000693	4.022,00 €
<b>SX2</b>		right droite	(3)	100102482	N710000776	4.022,00 €
		left gauche	(2)	100102483	N710000680	3.454,00 €
<b>SX3</b>		right droite	(3)	100102484	N710000766	4.255,00 €
		left gauche	(3)	100102485	N710000648	4.255,00 €
<b>SX4</b> <sup>(4)</sup>		right droite	(2)	100102486	N710000750	4.904,00 €
		left gauche	(3)	100102487	N710000716	5.712,00 €
<b>SX5</b> <sup>(4)</sup>		right droite	(3)	100102488	N710000658	5.712,00 €
		left gauche	(2)	100102489	N710000645	7.340,00 €
<b>SX6</b> <sup>(4)</sup>		right droite	(3)	100102490	N710000615	8.446,00 €
		left gauche	(3)	100102491	N710000607	8.446,00 €
<b>SX7</b> <sup>(4)</sup>		right droite	(2)	100102492	N710000765	5.189,00 €
		left gauche	(3)	100102493	N710000736	6.035,00 €
<b>SX8</b> <sup>(4)</sup>		right droite	(3)	100102494	N710000714	6.035,00 €
		left gauche	(3)	100102494	N710000714	6.035,00 €

### ACCESSORIES • ACCESSOIRES

	DESCRIPTION DESCRIPTION	COLOUR COULEUR	SAP	KEA	€	BASIC	FRAME CHASSIS	S0	SX1	SX2	SX3	SX4	SX5
	<sup>(1)</sup> Bath waste and overflow set NEXT + Syphon • <i>Vidage automatique NEXT + Syphon</i>		100060498	N780000002	51,00 €	✓	✓	✓					
	<sup>(1)</sup> NEXT bath filler waste and overflow set including bath trap • <i>Vidage NEXT avec bec verseur + Syphon</i>		100060521	N780000008	130,00 €	✓	✓	✓					
	COLD head rest • <i>Appui-tête COLD</i>		100066186	N770000052	91,00 €	✓	✓	✓	✓	✓	✓	✓	✓
	ENJOY head rest • <i>Appui-tête ENJOY</i>		100056383	N770000007	239,00 €								
			100056384	N770000034	239,00 €	✓	✓	✓	✓	✓	✓	✓	✓
			100056387	N770000017	239,00 €								
	ENJOY "S" head rest • <i>Appui-tête ENJOY "S"</i>		100060780	N770000049	198,00 €								
			100060753	N770000065	198,00 €	✓	✓	✓	✓	✓	✓	✓	✓
			100060767	N770000057	198,00 €								
	<sup>(2)</sup> Set of CASUAL PLUS support frame with feet • <i>Kit châssis universel CASUAL PLUS</i>		100057508	N770000042	39,00 €	✓							
	<sup>(3)</sup> Bath access panel • <i>Trappe de visite baignoire</i>		250021559	N790001316	331,00 €	✓	✓	✓	✓	✓	✓	✓	✓
	MODUL panel 170 • 170 Tablier MODUL		100056216	N770000146	188,00 €		✓	✓	✓	✓	✓	✓	✓
	MODUL panel 70 • 70 tablier MODUL		100056218	N770000152	111,00 €		✓	✓	✓	✓	✓	✓	✓
	CLUB panel 170 • 170 Tablier CLUB		100056096	N770000144	341,00 €								
			100056098	N770000140	368,00 €		✓	✓	✓	✓	✓	✓	✓
			100056097	N770000145	398,00 €								
			100056075	N770000113	176,00 €								
	CLUB panel 70 • 70 Tablier CLUB		100056077	N770000132	191,00 €		✓	✓	✓	✓	✓	✓	✓
			100056076	N770000114	203,00 €								

<sup>(1)</sup> Only required for the models not including brassware • *Nécessaire uniquement pour les modèles sans robinetterie*

<sup>(2)</sup> Recommended use of 2 sets • *On recommande 2 jeux pour ce modèle*

<sup>(3)</sup> Required for all built-in installations • *Nécessaire pour tous les modèles encastrés*

# MINIMAL XL

bathtubs - baignoires

## MINIMAL XL 170x75 cm.

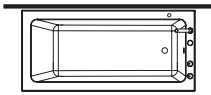
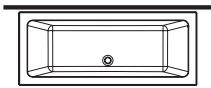

left  
gauche

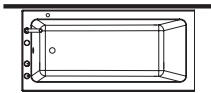

right  
droite

Water volume 239 l.  
Volume d'eau 239 l.



- <sup>(1)</sup> Bath waste not included  
*Vidage non inclus*
- <sup>(2)</sup> Waste included  
*Vidage inclus*
- <sup>(3)</sup> Bath waste and overflow set included with filler  
*Vidage automatique avec bec verseur*
- <sup>(4)</sup> Make sure that all the important equipment and LED lights can be easily accessed  
*Ne doit pas être encastrée sans possibilité d'accéder aux spots*

		FINISH FINITION	BRASSWARE ROBINETTERIE	SAP	KEA	€
<b>BASIC</b>			(1)	100050881	N710000074	543,00 €
		(3)		100050882	N710000078	1.545,00 €
<b>BATH WITH FRAME CHASSIS SANS HYDROMASSAGE</b>			(1)	100050883	N710000063	1.020,00 €
		(3)		100050884	N710000105	2.041,00 €
<b>S0</b>			(1)	100050885	N710000066	2.211,00 €
		right droite	(3)	100050886	N710000095	3.241,00 €
		left gauche	(3)	100050895	N710000071	3.241,00 €
<b>SX1</b>			(2)	100102495	N710000760	3.113,00 €
		right droite	(3)	100102496	N710000646	4.030,00 €
		left gauche	(3)	100102497	N710000632	4.030,00 €
<b>SX2</b>			(2)	100102498	N710000677	3.466,00 €
		right droite	(3)	100102499	N710000676	4.268,00 €
		left gauche	(3)	100102500	N710000825	4.268,00 €
<b>SX3</b>			(2)	100102501	N710000690	4.913,00 €
		right droite	(3)	100102502	N710000711	5.719,00 €
		left gauche	(3)	100102503	N710000688	5.719,00 €
<b>SX4</b> <sup>(4)</sup>			(2)	100102504	N710000773	7.347,00 €
		right droite	(3)	100102505	N710000613	8.454,00 €
		left gauche	(3)	100102506	N710000770	8.454,00 €
<b>SX5</b> <sup>(4)</sup>			(2)	100102507	N710000614	5.201,00 €
		right droite	(3)	100102508	N710000780	6.048,00 €
		left gauche	(3)	100102509	N710000598	6.048,00 €

### ACCESSORIES • ACCESSOIRES

	DESCRIPTION DESCRIPTION	COLOUR COULEUR	SAP	KEA	€	BASIC	FRAME CHASSIS	S0	SX1	SX2	SX3	SX4	SX5
	<sup>(1)</sup> Bath waste and overflow set NEXT + Syphon • <i>Vidage automatique NEXT + Syphon</i>		100060498	N780000002	51,00 €	✓	✓	✓					
	<sup>(1)</sup> NEXT bath filler waste and overflow set including bath trap • <i>Vidage NEXT avec bec verseur + Syphon</i>		100060521	N780000008	130,00 €	✓	✓	✓					
	COLD head rest • <i>Appui-tête COLD</i>		100066186	N770000052	91,00 €	✓	✓	✓	✓	✓	✓	✓	✓
	ENJOY head rest • <i>Appui-tête ENJOY</i>		100056383	N770000007	239,00 €								
			100056384	N770000034	239,00 €	✓	✓	✓	✓	✓	✓	✓	✓
			100056387	N770000017	239,00 €								
	ENJOY "S" head rest • <i>Appui-tête ENJOY "S"</i>		100060780	N770000049	198,00 €								
			100060753	N770000065	198,00 €	✓	✓	✓	✓	✓	✓	✓	✓
			100060767	N770000057	198,00 €								
	<sup>(2)</sup> Set of CASUAL PLUS support frame with feet • <i>Kit châssis universel CASUAL PLUS</i>		100057508	N770000042	39,00 €	✓							
	<sup>(3)</sup> Bath access panel • <i>Trappe de visite baignoire</i>		250021559	N790001316	331,00 €	✓	✓	✓	✓	✓	✓	✓	✓
	MODUL panel 170 • 170 Tablier MODUL		100056216	N770000146	188,00 €		✓	✓	✓	✓	✓	✓	✓
	MODUL panel 75 • 75 tablier MODUL		100056217	N770000157	111,00 €		✓	✓	✓	✓	✓	✓	✓
	CLUB panel 170 • 170 Tablier CLUB		100056096	N770000144	341,00 €								
			100056098	N770000140	368,00 €		✓	✓	✓	✓	✓	✓	✓
			100056097	N770000145	398,00 €								
			100056078	N770000116	180,00 €								
	CLUB panel 75 • 75 Tablier CLUB		100056080	N770000120	192,00 €		✓	✓	✓	✓	✓	✓	✓
			100056079	N770000142	205,00 €								

<sup>(1)</sup> Only required for the models not including brassware • *Nécessaire uniquement pour les modèles sans robinetterie*

<sup>(2)</sup> Recommended use of 2 sets • *On recommande 2 jeux pour ce modèle*

<sup>(3)</sup> Required for all built-in installations • *Nécessaire pour tous les modèles encastrés*

## MINIMAL XL 170x80 cm.

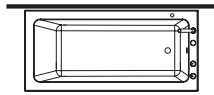
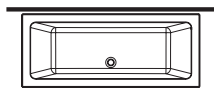

left  
gauche

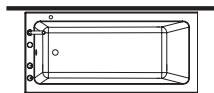

right  
droite

Water volume 261 l.  
Volume d'eau 261 l.



- <sup>(1)</sup> Bath waste not included  
*Vidage non inclus*
- <sup>(2)</sup> Waste included  
*Vidage inclus*
- <sup>(3)</sup> Bath waste and overflow set included with filler  
*Vidage automatique avec bec verseur*
- <sup>(4)</sup> Make sure that all the important equipment and LED lights can be easily accessed  
*Ne doit pas être encastrée sans possibilité d'accéder aux spots*

		FINISH FINITION	BRASSWARE ROBINETTERIE	SAP	KEA	€
<b>BASIC</b>			(1)	100050900	N710000088	590,00 €
		(3)		100050901	N710000125	1.592,00 €
<b>BATH WITH FRAME CHASSIS SANS HYDROMASSAGE</b>			(1)	100050902	N710000123	1.072,00 €
		(3)		100050903	N710000127	2.091,00 €
<b>S0</b>			(1)	100050904	N710000106	2.260,00 €
		right droite	(3)	100050905	N710000075	3.290,00 €
		left gauche	(3)	100050914	N710000092	3.290,00 €
<b>SX1</b>			(2)	100102510	N710000803	2.894,00 €
		right droite	(3)	100102511	N710000789	3.969,00 €
		left gauche	(3)	100102512	N710000777	3.969,00 €
<b>SX2</b>			(2)	100102513	N710000721	3.536,00 €
		right droite	(3)	100102514	N710000726	4.383,00 €
		left gauche	(3)	100102515	N710000698	4.383,00 €
<b>SX3</b>			(2)	100102516	N710000611	4.538,00 €
		right droite	(3)	100102517	N710000654	5.613,00 €
		left gauche	(3)	100102518	N710000729	5.613,00 €
<b>SX4</b> <sup>(4)</sup>			(2)	100102519	N710000757	7.196,00 €
		right droite	(3)	100102520	N710000667	8.271,00 €
		left gauche	(3)	100102521	N710000758	8.271,00 €
<b>SX5</b> <sup>(4)</sup>			(2)	100102522	N710000749	5.271,00 €
		right droite	(3)	100102523	N710000741	6.118,00 €
		left gauche	(3)	100102524	N710000841	6.118,00 €

### ACCESSORIES • ACCESSOIRES

	DESCRIPTION DESCRIPTION	COLOUR COULEUR	SAP	KEA	€	BASIC	FRAME CHASSIS	S0	SX1	SX2	SX3	SX4	SX5
	<sup>(1)</sup> Bath waste and overflow set NEXT + Syphon • <i>Vidage automatique NEXT + Syphon</i>		100060498	N780000002	51,00 €	✓	✓	✓					
	<sup>(1)</sup> NEXT bath filler waste and overflow set including bath trap • <i>Vidage NEXT avec bec verseur + Syphon</i>		100060521	N780000008	130,00 €	✓	✓	✓					
	COLD head rest • <i>Appui-tête COLD</i>		100066186	N770000052	91,00 €	✓	✓	✓	✓	✓	✓	✓	✓
	ENJOY head rest • <i>Appui-tête ENJOY</i>		100056383	N770000007	239,00 €								
			100056384	N770000034	239,00 €	✓	✓	✓	✓	✓	✓	✓	✓
			100056387	N770000017	239,00 €								
	ENJOY "S" head rest • <i>Appui-tête ENJOY "S"</i>		100060780	N770000049	198,00 €								
			100060753	N770000065	198,00 €	✓	✓	✓	✓	✓	✓	✓	✓
			100060767	N770000057	198,00 €								
	<sup>(2)</sup> Set of CASUAL PLUS support frame with feet • <i>Kit châssis universel CASUAL PLUS</i>		100060499	N770000066	49,00 €	✓							
	<sup>(3)</sup> Bath access panel • <i>Trappe de visite baignoire</i>		250021559	N790001316	331,00 €	✓	✓	✓	✓	✓	✓	✓	✓
	MODUL panel 170 • 170 Tablier MODUL		100056216	N770000146	188,00 €		✓	✓	✓	✓	✓	✓	✓
	MODUL panel 80 • 80 tablier MODUL		100056218	N770000152	111,00 €		✓	✓	✓	✓	✓	✓	✓
	CLUB panel 170 • 170 Tablier CLUB		100056096	N770000144	341,00 €								
			100056098	N770000140	368,00 €		✓	✓	✓	✓	✓	✓	✓
			100056097	N770000145	398,00 €								
			100056075	N770000113	184,00 €								
	CLUB panel 80 • 80 Tablier CLUB		100056077	N770000132	196,00 €		✓	✓	✓	✓	✓	✓	✓
			100056076	N770000114	211,00 €								

<sup>(1)</sup> Only required for the models not including brassware • *Nécessaire uniquement pour les modèles sans robinetterie*

<sup>(2)</sup> Recommended use of 2 sets • *On recommande 2 jeux pour ce modèle*

<sup>(3)</sup> Required for all built-in installations • *Nécessaire pour tous les modèles encastrés*

# MINIMAL XL

bathubs - baignoires

## MINIMAL XL 180x80 cm.

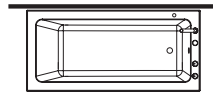
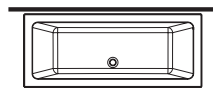

left  
gauche



right  
droite

Water volume 282 l.  
Volume d'eau 282 l.



- <sup>(1)</sup> Bath waste not included  
*Vidage non inclus*
- <sup>(2)</sup> Waste included  
*Vidage inclus*
- <sup>(3)</sup> Bath waste and overflow set included with filler  
*Vidage automatique avec bec verseur*
- <sup>(4)</sup> Make sure that all the important equipment and LED lights can be easily accessed  
*Ne doit pas être encastrée sans possibilité d'accéder aux spots*

		FINISH FINITION	BRASSWARE ROBINETTERIE	SAP	KEA	€
<b>BASIC</b>			(1)	100050919	N710000103	590,00 €
		(3)		100050920	N710000112	1.592,00 €
<b>BATH WITH FRAME CHASSIS SANS HYDROMASSAGE</b>			(1)	100050921	N710000108	1.112,00 €
		(3)		100050922	N710000100	2.091,00 €
<b>S0</b>			(1)	100050923	N710000096	2.260,00 €
		right droite	(3)	100050924	N710000120	3.290,00 €
		left gauche	(3)	100050933	N710000099	3.290,00 €
<b>SX1</b>			(2)	100102525	N710000755	2.894,00 €
		right droite	(3)	100102526	N710000689	3.969,00 €
		left gauche	(3)	100102527	N710000762	3.969,00 €
<b>SX2</b>			(2)	100102528	N710000793	3.533,00 €
		right droite	(3)	100102529	N710000719	4.380,00 €
		left gauche	(3)	100102530	N710000715	4.380,00 €
<b>SX3</b>			(2)	100102531	N710000708	4.538,00 €
		right droite	(3)	100102532	N710000809	5.613,00 €
		left gauche	(3)	100102533	N710000730	5.613,00 €
<b>SX4</b> <sup>(4)</sup>			(2)	100102534	N710000756	7.196,00 €
		right droite	(3)	100102535	N710000772	8.271,00 €
		left gauche	(3)	100102536	N710000728	8.271,00 €
<b>SX5</b> <sup>(4)</sup>			(2)	100102537	N710000734	5.268,00 €
		right droite	(3)	100102538	N710000835	6.115,00 €
		left gauche	(3)	100102539	N710000669	6.115,00 €

### ACCESSORIES • ACCESSOIRES

	DESCRIPTION DESCRIPTION	COLOUR COULEUR	SAP	KEA	€	BASIC	FRAME CHASSIS	S0	SX1	SX2	SX3	SX4	SX5
	<sup>(1)</sup> Bath waste and overflow set NEXT + Syphon • <i>Vidage automatique NEXT + Syphon</i>		100060498	N780000002	51,00 €	✓	✓	✓					
	<sup>(1)</sup> NEXT bath filler waste and overflow set including bath trap • <i>Vidage NEXT avec bec verseur + Syphon</i>		100060521	N780000008	130,00 €	✓	✓	✓					
	COLD head rest • <i>Appui-tête COLD</i>		100066186	N770000052	91,00 €	✓	✓	✓	✓	✓	✓	✓	✓
	ENJOY head rest • <i>Appui-tête ENJOY</i>		100056383	N770000007	239,00 €								
			100056384	N770000034	239,00 €	✓	✓	✓	✓	✓	✓	✓	✓
			100056387	N770000017	239,00 €								
	ENJOY "S" head rest • <i>Appui-tête ENJOY "S"</i>		100060780	N770000049	198,00 €								
			100060753	N770000065	198,00 €	✓	✓	✓	✓	✓	✓	✓	✓
			100060767	N770000057	198,00 €								
	<sup>(2)</sup> Set of CASUAL PLUS support frame with feet • <i>Kit châssis universel CASUAL PLUS</i>		100060499	N770000066	49,00 €	✓							
	<sup>(3)</sup> Bath access panel • <i>Trappe de visite baignoire</i>		250021559	N790001316	331,00 €	✓	✓	✓	✓	✓	✓	✓	✓
	MODUL panel 180 • 180 <i>Tablier MODUL</i>		100056222	N770000153	220,00 €		✓	✓	✓	✓	✓	✓	✓
	MODUL panel 80 • 80 <i>tablier MODUL</i>		100056219	N770000150	111,00 €		✓	✓	✓	✓	✓	✓	✓
	CLUB panel 180 • 180 <i>Tablier CLUB</i>		100056099	N770000130	354,00 €								
			100056101	N770000133	383,00 €		✓	✓	✓	✓	✓	✓	✓
			100056100	N770000118	414,00 €								
			100056081	N770000117	184,00 €								
	CLUB panel 80 • 80 <i>Tablier CLUB</i>		100056083	N770000136	196,00 €		✓	✓	✓	✓	✓	✓	✓
			100056082	N770000124	211,00 €								

<sup>(1)</sup> Only required for the models not including brassware • *Nécessaire uniquement pour les modèles sans robinetterie*

<sup>(2)</sup> Recommended use of 2 sets • *On recommande 2 jeux pour ce modèle*

<sup>(3)</sup> Required for all built-in installations • *Nécessaire pour tous les modèles encastrés*

## MINIMAL XL 190x90 cm.

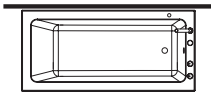
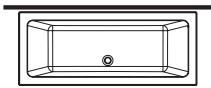

left  
gauche

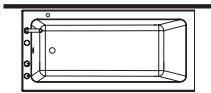

right  
droite

Water volume 351 l.  
Volume d'eau 351 l.



- <sup>(1)</sup> Bath waste not included  
*Vidage non inclus*
- <sup>(2)</sup> Waste included  
*Vidage inclus*
- <sup>(3)</sup> Bath waste and overflow set included with filler  
*Vidage automatique avec bec verseur*
- <sup>(4)</sup> Make sure that all the important equipment and LED lights can be easily accessed  
*Ne doit pas être encastrée sans possibilité d'accéder aux spots*

		FINISH FINITION	BRASSWARE ROBINETTERIE	SAP	KEA	€
<b>BASIC</b>			(1)	100050938	N710000114	724,00 €
		(3)		100050939	N710000115	1.725,00 €
<b>BATH WITH FRAME CHASSIS SANS HYDROMASSAGE</b>			(1)	100050940	N710000102	1.265,00 €
		(3)		100050941	N710000126	2.236,00 €
<b>S0</b>		right droite	(1)	100050942	N710000129	2.402,00 €
		left gauche	(3)	100050943	N710000139	3.432,00 €
<b>SX1</b>		right droite	(2)	100102555	N710000631	3.042,00 €
		left gauche	(3)	100102556	N710000784	4.117,00 €
<b>SX2</b>		right droite	(3)	100102557	N710000823	4.117,00 €
		left gauche	(2)	100102558	N710000641	3.667,00 €
<b>SX3</b>		right droite	(3)	100102559	N710000844	4.514,00 €
		left gauche	(3)	100102560	N710000735	4.514,00 €
<b>SX4</b> <sup>(4)</sup>		right droite	(2)	100102561	N710000713	4.686,00 €
		left gauche	(3)	100102562	N710000709	5.761,00 €
<b>SX5</b> <sup>(4)</sup>		right droite	(3)	100102563	N710000682	5.761,00 €
		left gauche	(2)	100102564	N710000817	7.344,00 €
<b>SX4</b> <sup>(4)</sup>		right droite	(3)	100102565	N710000779	8.420,00 €
		left gauche	(3)	100102566	N710000785	8.420,00 €
<b>SX5</b> <sup>(4)</sup>		right droite	(2)	100102567	N710000783	5.402,00 €
		left gauche	(3)	100102568	N710000769	6.248,00 €
<b>SX5</b> <sup>(4)</sup>		right droite	(3)	100102569	N710000661	6.248,00 €
		left gauche	(3)	100102569	N710000661	6.248,00 €

### ACCESSORIES • ACCESSOIRES

	DESCRIPTION DESCRIPTION	COLOUR COULEUR	SAP	KEA	€	BASIC	FRAME CHASSIS	S0	SX1	SX2	SX3	SX4	SX5
	<sup>(1)</sup> Bath waste and overflow set NEXT + Syphon • <i>Vidage automatique NEXT + Syphon</i>		100060498	N780000002	51,00 €	✓	✓	✓					
	<sup>(1)</sup> NEXT bath filler waste and overflow set including bath trap • <i>Vidage NEXT avec bec verseur + Syphon</i>		100060521	N780000008	130,00 €	✓	✓	✓					
	COLD head rest • <i>Appui-tête COLD</i>		100066186	N770000052	91,00 €	✓	✓	✓	✓	✓	✓	✓	✓
	ENJOY head rest • <i>Appui-tête ENJOY</i>		100056383	N770000007	239,00 €								
			100056384	N770000034	239,00 €	✓	✓	✓	✓	✓	✓	✓	✓
			100056387	N770000017	239,00 €								
	ENJOY "S" head rest • <i>Appui-tête ENJOY "S"</i>		100060780	N770000049	198,00 €								
			100060753	N770000065	198,00 €	✓	✓	✓	✓	✓	✓	✓	✓
			100060767	N770000057	198,00 €								
	<sup>(2)</sup> Set of CASUAL PLUS support frame with feet • <i>Kit châssis universel CASUAL PLUS</i>		100060499	N770000066	49,00 €	✓							
	<sup>(3)</sup> Bath access panel • <i>Trappe de visite baignoire</i>		250021559	N790001316	331,00 €	✓	✓	✓	✓	✓	✓	✓	✓
	MODUL panel 190 • 190 Tablier MODUL		100056223	N770000159	232,00 €		✓	✓	✓	✓	✓	✓	✓
	MODUL panel 90 • 90 tablier MODUL		100056220	N770000147	111,00 €		✓	✓	✓	✓	✓	✓	✓
	CLUB panel 190 • 190 Tablier CLUB		100056102	N770000141	371,00 €								
			100056104	N770000127	402,00 €		✓	✓	✓	✓	✓	✓	✓
			100056103	N770000131	434,00 €								
			100056084	N770000115	194,00 €								
	CLUB panel 90 • 90 Tablier CLUB		100056086	N770000137	208,00 €		✓	✓	✓	✓	✓	✓	✓
			100056085	N770000119	224,00 €								

<sup>(1)</sup> Only required for the models not including brassware • *Nécessaire uniquement pour les modèles sans robinetterie*

<sup>(2)</sup> Recommended use of 2 sets • *On recommande 2 jeux pour ce modèle*

<sup>(3)</sup> Required for all built-in installations • *Nécessaire pour tous les modèles encastrés*

# MINIMAL DUO

bathtubs - baignoires



bathtubs / baignoires MINIMAL DUO

## COLOURS • COULEURS



CLUB panel  
tablier CLUB



white  
blanc



black  
noir



Inox

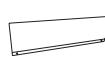

MODUL panel  
tablier MODUL



white  
blanc



chrome / white  
chromé / blanc



Chrome  
Chromé

## ACCESSORIES • ACCESSOIRES



ENJOY head rest  
Appui-tête ENJOY



ENJOY "S" head rest  
Appui-tête ENJOY "S"

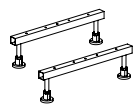

Set of universal support  
frame with feet  
Châssis universel avec  
pieds



CLUB panel  
tablier CLUB



MODUL panel  
tablier MODUL



access panel  
trappe de visite



bath waste and  
overflow set  
vidage automatique



bath filler waste and over-  
flow set  
automatique vidage bec  
verseur



deck mounted valves and  
handset  
robinetterie

# MINIMAL DUO

bathtubs - baignoires

## SIZES cm. • FORMATS cm.

190x120 • 61h

## EQUIPMENT • EQUIPEMENT

		S0	SX1	SX2	SX3	SX4	SX5
JETS		6	-	14	14	14	-
BLOWERS		-	10	-	10	10	10
CHROMOTHERAPY CHROMOTHERAPIE		-	-	-	-	10	10
DISINFECTION DÉSINFECTION		-	-	-	-	✓	-

See features on page 22-25.

Consultez caractéristiques en page 22-25.

## DRAWINGS mm. • PLANS mm.

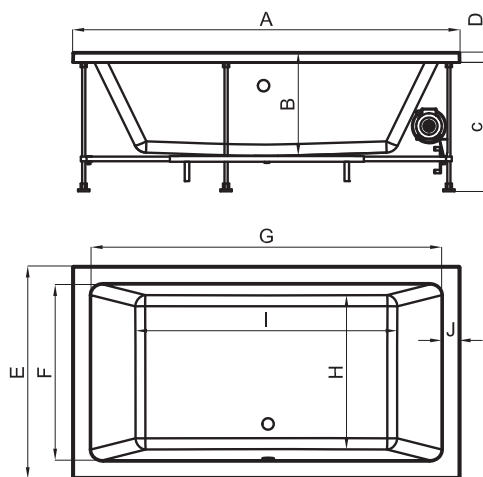

mm	A	B	C	D	E	F	G	H	I	J
1900 x 1200	1900	470	565	45	1200	1040	1740	940	1340	80

## PRE-INSTALLING • PRE-INSTALLATION

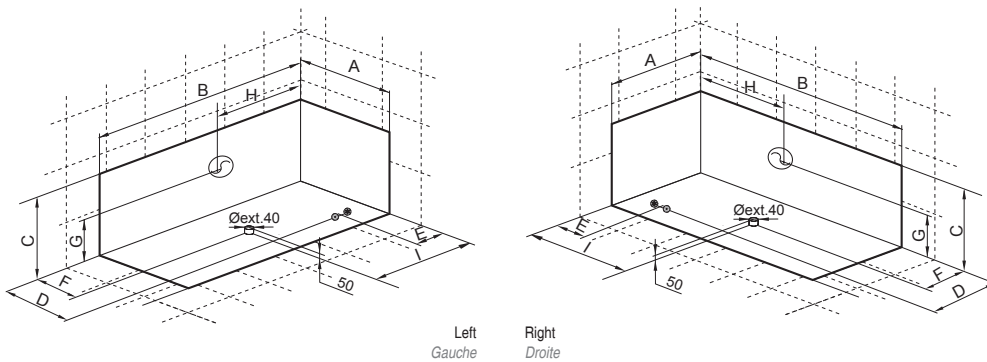

Left  
Gauche

Right  
Droite

	Hot water connections Prise d'eau chaude
	Cold water connections Prise d'eau froide
	Waste Vidage
	Electrical connections Câblage électrique

mm	A	B	C	D	E	F	G	H	I
1900 x 1200	1200	1900	610	800	250	600	300	950	950



# MINIMAL DUO

bathtubs - baignoires

## PACKAGING DETAILS • DONNÉES D'EXPÉDITION

	DIMENSIONS DIMENSIONS		VOLUME VOLUME	NET WEIGHT / PIECE POIDS NET / PIÈCE	GROSS WEIGHT / PALLET POIDS BRUT / PALETTE	PIECES / PALLET PIÈCES / PALETTE
BASIC	L W H	192 cm 125 cm 120 cm	2,4 m <sup>3</sup>	51 Kg	430 Kg	8
BATH WITH FRAME CHASSIS SANS HYDROMAS- SAGE	L W H	195 cm 125cm 69 cm	1,68 m <sup>3</sup>	61,5 Kg	72 Kg	1
S0	L W H	195 cm 125cm 69 cm	1,68 m <sup>3</sup>	73,5 Kg	84 Kg	1
SX1	L W H	195 cm 125cm 69 cm	1,68 m <sup>3</sup>	68,5 Kg	79 Kg	1
SX2	L W H	195 cm 125cm 69 cm	1,68 m <sup>3</sup>	77,5 Kg	88 Kg	1
SX3	L W H	195 cm 125cm 69 cm	1,68 m <sup>3</sup>	84,5 Kg	95 Kg	1
SX4	L W H	195 cm 125cm 69 cm	1,68 m <sup>3</sup>	89,5 Kg	100 Kg	1
SX5	L W H	195 cm 125cm 69 cm	1,68 m <sup>3</sup>	69,5 Kg	80 Kg	1

# MINIMAL DUO

bathtubs - baignoires

## MINIMAL DUO 190x120 cm.

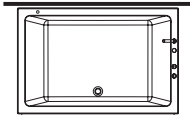
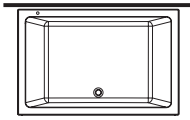

left  
gauche

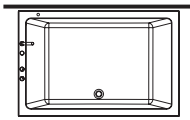

right  
droite

Water volume 510 l.  
Volume d'eau 510 l.



- <sup>(1)</sup> Bath waste not included  
*Vidage non inclus*
- <sup>(2)</sup> Waste included  
*Vidage inclus*
- <sup>(3)</sup> Bath waste and overflow set included with filler  
*Vidage automatique avec bec verseur*
- <sup>(4)</sup> Make sure that all the important equipment and LED lights can be easily accessed  
*Ne doit pas être encastrée sans possibilité d'accéder aux spots*

		FINISH FINITION	BRASSWARE ROBINETTERIE	SAP	KEA	€
<b>BASIC</b>			(1)	100056665	N710000203	1.841,00 €
		(3)		100056666	N710000231	2.831,00 €
<b>BATH WITH FRAME CHASSIS SANS HYDROMASSAGE</b>			(1)	100056667	N710000151	2.840,00 €
		(3)		100056668	N710000171	3.850,00 €
<b>S0</b>		right droite	(1)	100056669	N710000141	3.498,00 €
		left gauche	(3)	100056670	N710000153	4.569,00 €
<b>SX1</b>		right droite	(2)	100102540	N710000612	4.056,00 €
		left gauche	(3)	100102541	N710000753	5.146,00 €
<b>SX2</b>		right droite	(3)	100102542	N710000790	5.146,00 €
		left gauche	(2)	100102543	N710000606	4.890,00 €
<b>SX3</b>		right droite	(3)	100102544	N710000839	5.736,00 €
		left gauche	(3)	100102545	N710000697	5.736,00 €
<b>SX4</b> <sup>(4)</sup>		right droite	(2)	100102546	N710000671	5.876,00 €
		left gauche	(3)	100102547	N710000662	6.966,00 €
<b>SX5</b> <sup>(4)</sup>		right droite	(3)	100102548	N710000771	6.966,00 €
		left gauche	(2)	100102549	N710000737	8.193,00 €
<b>SX6</b> <sup>(4)</sup>		right droite	(3)	100102550	N710000787	9.284,00 €
		left gauche	(3)	100102551	N710000764	9.284,00 €
<b>SX7</b> <sup>(4)</sup>		right droite	(2)	100102552	N710000696	6.514,00 €
		left gauche	(3)	100102553	N710000774	7.361,00 €
<b>SX8</b> <sup>(4)</sup>		right droite	(3)	100102554	N710000801	7.361,00 €
		left gauche	(3)	100102555	N710000801	7.361,00 €

### ACCESSORIES • ACCESSOIRES

	DESCRIPTION DESCRIPTION	COLOUR COULEUR	SAP	KEA	€	BASIC	FRAME CHASSIS	S0	SX1	SX2	SX3	SX4	SX5
	<sup>(1)</sup> Bath waste and overflow set NEXT + Syphon • <i>Vidage automatique NEXT + Syphon</i>		100060498	N780000002	51,00 €	✓	✓	✓					
	<sup>(1)</sup> NEXT bath filler waste and overflow set including bath trap • <i>Vidage NEXT avec bec verseur + Syphon</i>		100060521	N780000008	130,00 €	✓	✓	✓					
	COLD head rest • <i>Appui-tête COLD</i>		100066186	N770000052	91,00 €	✓	✓	✓	✓	✓	✓	✓	✓
	ENJOY head rest • <i>Appui-tête ENJOY</i>		100056383	N770000007	239,00 €				✓				✓
	ENJOY "S" head rest • <i>Appui-tête ENJOY "S"</i>		100056384	N770000034	239,00 €	✓	✓		✓				✓
			100056387	N770000017	239,00 €				✓				✓
			100060780	N770000049	198,00 €				✓				✓
			100060753	N770000065	198,00 €	✓	✓	✓	✓	✓	✓	✓	✓
			100060767	N770000057	198,00 €				✓				✓
	<sup>(2)</sup> Set of universal support frame with feet • <i>Châssis universel avec pieds</i>		100096848	N710000628	75,00 €	✓							
	<sup>(3)</sup> Bath access panel • <i>Trappe de visite baignoire</i>		250021559	N790001316	331,00 €	✓	✓	✓	✓	✓	✓	✓	✓
	MODUL panel 190 • 190 Tablier MODUL		100056223	N770000159	232,00 €		✓	✓	✓	✓	✓	✓	✓
	MODUL panel 120 • 120 tablier MODUL		100057503	N770000012	186,00 €		✓	✓	✓	✓	✓	✓	✓
	CLUB panel 190 • 190 Tablier CLUB		100056102	N770000141	371,00 €				✓			✓	✓
			100056104	N770000127	402,00 €		✓	✓	✓	✓	✓	✓	✓
			100056103	N770000131	434,00 €				✓			✓	✓
			100056087	N770000134	221,00 €				✓			✓	✓
	CLUB panel 120 • 120 Tablier CLUB		100056089	N770000129	240,00 €		✓	✓	✓	✓	✓	✓	✓
			100056088	N770000122	261,00 €				✓			✓	✓

<sup>(1)</sup> Only required for the models not including brassware • *Nécessaire uniquement pour les modèles sans robinetterie*

<sup>(2)</sup> Recommended use of 2 sets • *On recommande 2 jeux pour ce modèle*

<sup>(3)</sup> Required for all built-in installations • *Nécessaire pour tous les modèles encastrés*

# MINIMAL OFFSET

bathtubs - baignoires



bathtubs / baignoires MINIMAL OFFSET

## COLOURS • COULEURS

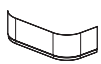

MINIMAL OFFSET  
panel  
tablier MINIMAL  
OFFSET



white  
blanc



chrome / white  
chromé / blanc



Chrome  
Chromé

## ACCESSORIES • ACCESSOIRES



ENJOY head rest  
Appui-tête ENJOY



ENJOY "S" head rest  
Appui-tête ENJOY "S"



MILD head rest  
Appui-tête MILD

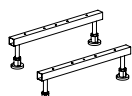

Set of universal support  
frame with feet  
Châssis universel avec  
pieds



MINIMAL OFFSET panel  
tablier MINIMAL OFFSET



access panel  
trappe de visite



bath waste and  
overflow set  
vidage automatique



bath filler waste and over-  
flow set  
automatique vidage bec  
verseur



deck mounted valves and  
handset  
robinetterie

# MINIMAL OFFSET

bathtubs - baignoires

SIZES cm. • FORMATS cm.

150x75 • 61h

EQUIPMENT • EQUIPEMENT

		S0	SX1	SX2	SX3	SX4	SX5
JETS		6	-	8	8	8	-
BLOWERS		-	8	-	8	8	8
CHROMOTHERAPY CHROMOTHERAPIE		-	-	-	-	8	8
DISINFECTION DÉSINFECTION		-	-	-	-	✓	-

See features on page 22-25.

Consultez caractéristiques en page 22-25.

DRAWINGS mm. • PLANS mm.

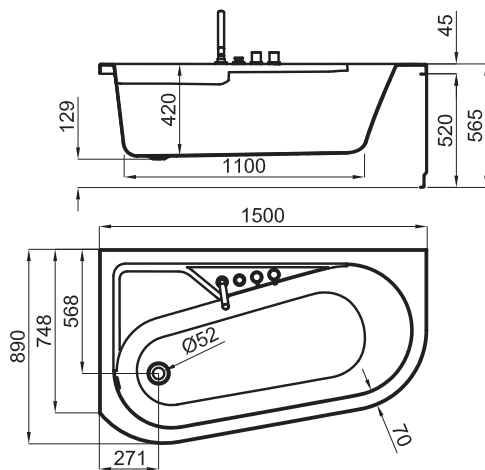

PRE-INSTALLING • PRE-INSTALLATION

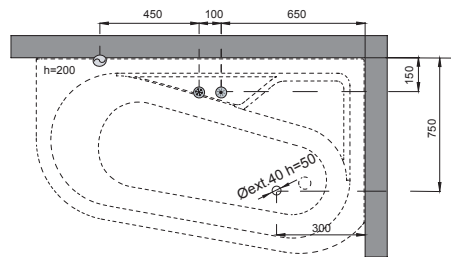
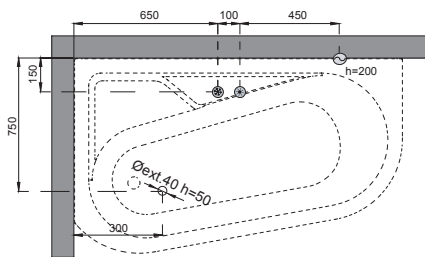

	Hot water connections Prise d'eau chaude
	Cold water connections Prise d'eau froide
	Waste Vidage
	Electrical connections Câblage électrique

Left  
Gauche

Right  
Droite

# MINIMAL OFFSET

bathtubs - baignoires

## PACKAGING DETAILS • DONNÉES D'EXPÉDITION

	DIMENSIONS DIMENSIONS		VOLUME VOLUME	NET WEIGHT / PIECE POIDS NET / PIÈCE	GROSS WEIGHT / PALLET POIDS BRUT / PALETTE	PIECES / PALLET PIÈCES / PALETTE
BASIC	L W H	175 cm 125 cm 190 cm	4,2 m <sup>3</sup>	30 Kg	620 Kg	20
BATH WITH FRAME CHASSIS SANS HYDROMAS- SAGE	L W H	190 cm 90 cm 75 cm	1,2 m <sup>3</sup>	43 Kg	49 Kg	1
S0	L W H	190 cm 90 cm 75 cm	1,2 m <sup>3</sup>	50 Kg	56 Kg	1
SX1	L W H	190 cm 90 cm 75 cm	1,2 m <sup>3</sup>	49 Kg	55 Kg	1
SX2	L W H	190 cm 90 cm 75 cm	1,2 m <sup>3</sup>	52 Kg	58 Kg	1
SX3	L W H	190 cm 90 cm 75 cm	1,2 m <sup>3</sup>	54 Kg	60 Kg	1
SX4	L W H	190 cm 90 cm 75 cm	1,2 m <sup>3</sup>	60 Kg	66 Kg	1
SX5	L W H	190 cm 90 cm 75 cm	1,2 m <sup>3</sup>	50 Kg	56 Kg	1

# MINIMAL OFFSET

bathubs - baignoires

## MINIMAL OFFSET 150x75 cm.

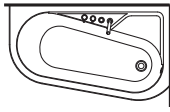

left  
gauche

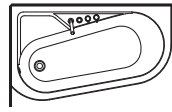

right  
droite

Water volume 174 l.  
Volume d'eau 174 l.

		POSITION POSITION	PANEL TABLIER	BRASSWARE ROBINETTERIE	SAP	KEA	€
<b>BASIC</b>		right droite		(1)	100142666	N710001138	641,00 €
				(2)	100142667	N710001055	1.868,00 €
		left gauche		(1)	100142669	N710001128	641,00 €
				(2)	100142668	N710001062	1.868,00 €
<b>BATH WITH FRAME CHASSIS SANS HYDROMASSAGE</b>		right droite		(1)	100142670	N710001096	1.258,00 €
				(2)	100142672	N710001053	2.282,00 €
				(1)	100142671	N710001081	1.802,00 €
				(2)	100142673	N710001007	2.826,00 €
		left gauche		(1)	100142680	N710001073	1.258,00 €
				(2)	100142674	N710001037	2.282,00 €
				(1)	100142681	N710001076	1.802,00 €
				(2)	100142675	N710001049	2.826,00 €
<b>S0</b>		right droite		(1)	100142690	N710001058	2.295,00 €
				(2)	100142692	N710001124	3.375,00 €
				(1)	100142691	N710001104	2.839,00 €
				(2)	100142693	N710001084	3.919,00 €
		left gauche		(1)	100142694	N710001144	2.295,00 €
				(2)	100142696	N710001135	3.375,00 €
				(1)	100142695	N710001146	2.839,00 €
				(2)	100142697	N710001059	3.919,00 €
<b>SX1</b>		right droite		(2)	100142687	N710001102	3.326,00 €
				(3)	100142689	N710001039	4.356,00 €
				(2)	100142688	N710001108	3.892,00 €
				(3)	100142700	N710001035	4.922,00 €
		left gauche		(2)	100142710	N710001018	3.326,00 €
				(3)	100142712	N710001136	4.356,00 €
				(2)	100142711	N710001048	3.892,00 €
				(3)	100142713	N710001105	4.922,00 €
<b>SX2</b>		right droite		(2)	100142637	N710000959	3.605,00 €
				(3)	100142639	N710001078	4.631,00 €
				(2)	100142638	N710000907	4.194,00 €
				(3)	100142720	N710001121	5.265,00 €
		left gauche		(2)	100142698	N710001147	3.605,00 €
				(3)	100142730	N710000925	4.631,00 €
				(2)	100142699	N710001095	4.194,00 €
				(3)	100142731	N710000978	5.265,00 €



<sup>(1)</sup> Bath waste not included • Vidage non inclus













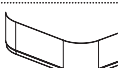



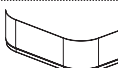

<sup>(2)</sup> Waste included • Vidage inclus

<sup>(3)</sup> Bath waste and overflow set included with filler • Vidage automatique avec bec verseur

<sup>(4)</sup> Make sure that all the important equipment and LED lights can be easily accessed  
Ne doit pas être encastrée sans possibilité d'accéder aux spots

# MINIMAL OFFSET

bathtubs - baignoires

	POSITION POSITION	PANEL TABLIER	BRASSWARE ROBINETTERIE	SAP	KEA	€
<b>SX3</b> 	right droite		(2)	100142714	N710001149	4.922,00 €
			(3) 	100142716	N710001085	5.952,00 €
			(2)	100142715	N710001093	5.486,00 €
	left gauche		(3) 	100142717	N710001110	6.511,00 €
			(2)	100142732	N710001071	4.922,00 €
			(3) 	100142734	N710001063	5.952,00 €
<b>SX4</b> <sup>(4)</sup> 	right droite		(2)	100142736	N710001080	7.492,00 €
			(3) 	100142738	N710001141	8.544,00 €
			(2)	100142737	N710001154	8.074,00 €
	left gauche		(3) 	100142739	N710001109	9.089,00 €
			(2)	100142740	N710001150	7.492,00 €
			(3) 	100142742	N710001072	8.544,00 €
<b>SX5</b> <sup>(4)</sup> 	right droite		(2)	100142748	N710001113	5.420,00 €
			(3) 	100142750	N710001140	6.240,00 €
			(2)	100142749	N710001097	6.008,00 €
	left gauche		(3) 	100142751	N710001111	6.800,00 €
			(2)	100142744	N710001087	5.420,00 €
			(3) 	100142746	N710001064	6.240,00 €
			(2)	100142745	N710001067	6.008,00 €
			(3) 	100142747	N710001047	6.800,00 €



<sup>(1)</sup> Bath waste not included • Vidage non inclus



















<sup>(2)</sup> Waste included • Vidage inclus

<sup>(3)</sup> Bath waste and overflow set included with filler • Vidage automatique avec bec verseur

<sup>(4)</sup> Make sure that all the important equipment and LED lights can be easily accessed

Ne doit pas être encastrée sans possibilité d'accéder aux spots

## ACCESSORIES • ACCESSOIRES

	DESCRIPTION DESCRIPTION	COLOUR COULEUR	SAP	KEA	€	BASIC	FRAME CHASSIS	S0	SX1	SX2	SX3	SX4	SX5
	<sup>(1)</sup> Bath waste and overflow set NEXT + Syphon • Vidage automatique NEXT + Syphon		100060498	N780000002	51,00 €	✓	✓	✓					
	<sup>(1)</sup> NEXT bath filler waste and overflow set including bath trap • Vidage NEXT avec bec verseur + Syphon		100060521	N780000008	130,00 €	✓	✓	✓					
	MILD head rest • Appui-tête ENJOY		100066187	N770000050	91,00 €	✓	✓	✓	✓	✓	✓	✓	✓
			100056383	N770000007	239,00 €								
	ENJOY head rest • Appui-tête ENJOY		100056384	N770000034	239,00 €	✓	✓	✓	✓	✓	✓	✓	✓
			100056387	N770000017	239,00 €								
			100060780	N770000049	198,00 €								
	ENJOY "S" head rest • Appui-tête ENJOY "S"		100060753	N770000065	198,00 €	✓	✓	✓	✓	✓	✓	✓	✓
			100060767	N770000057	198,00 €								
	Set of universal support frame with feet • Châssis universel avec pieds		100096848	N710000628	75,00 €	✓							
	<sup>(2)</sup> Bath access panel • Trappe de visite baignoire		250021559	N790001316	331,00 €	✓	✓	✓	✓	✓	✓	✓	✓

<sup>(1)</sup> Only required for the models not including brassware • Nécessaire uniquement pour les modèles sans robinetterie

<sup>(2)</sup> Required for all built-in installations • Nécessaire pour tous les modèles encastrés

# MINIMAL OVAL

bathtubs - baignoires



bathtubs / baignoires MINIMAL OVAL

## COLOURS • COULEURS

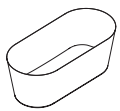

white acrylic  
acrylique blanc



chrome / white  
chromé / blanc



Chrome  
Chromé

## ACCESSORIES • ACCESSOIRES



ENJOY head rest  
Appui-tête ENJOY



ENJOY "S" head rest  
Appui-tête ENJOY "S"



MILD head rest  
Appui-tête MILD



OVAL panel  
tablier OVAL



access panel  
trappe de visite



bath waste and  
overflow set  
vidage automatique



deck mounted bath  
filler set  
Robinetterie avec bec  
sur plage

## SIZES cm. • FORMATS cm.





175x80 • 58,5h  
190x87 • 58,5h



# MINIMAL OVAL

bathtubs - baignoires

## EQUIPMENT • EQUIPEMENT

		SX1	SX5
JETS		x	x
BLOWERS		12	12
CHROMOTHERAPY CHROMOTHERAPIE		x	12
DISINFECTION DÉSINFECTION		x	x

See features on page 22-25.

Consultez caractéristiques en page 22-25.



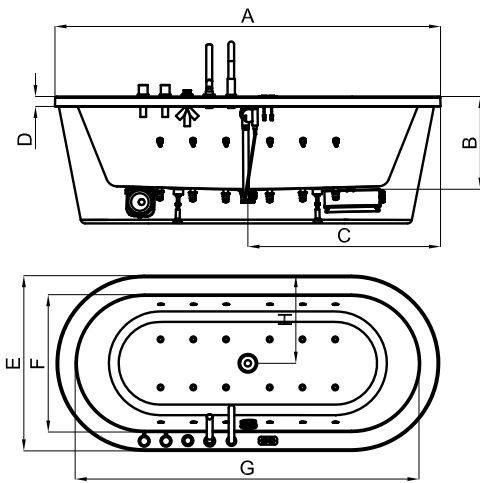

## DRAWINGS mm. • PLANS mm.

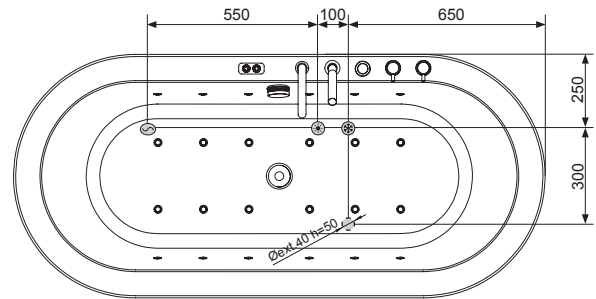

mm	A	B	C	D	E	F	G	H
1750 x 800	1750	440	875	45	800	620	1570	400
1900 x 870	1900	440	950	45	870	675	1700	435

## PRE-INSTALLING • PRE-INSTALLATION



	Hot water connections Prise d'eau chaude
	Cold water connections Prise d'eau froide
	Waste Vidage
	Electrical connections Câblage électrique

## PACKAGING DETAILS • DONNÉES D'EXPÉDITION

		DIMENSIONS DIMENSIONS		VOLUME VOLUME	NET WEIGHT / PIECE POIDS NET / PIÈCE	GROSS WEIGHT / PALLET POIDS BRUT / PALETTE	PIECES / PALLET PIÈCES / PALETTE
175 x 80	BASIC WITH LEGS BASIC AVEC PIEDS	L	180 cm	1,99 m <sup>3</sup>	23,5 Kg	250 Kg	10
		W	85 cm				
		H	130 cm				
	CENTER	L	180 cm				
		W	85 cm	1,15 m <sup>3</sup>	50 Kg	68 Kg	1
		H	75 cm				
SX1	L	180 cm					
		W	85 cm				
		H	75 cm	1,15 m <sup>3</sup>	64 Kg	75 Kg	1
SX5	L	180 cm					
		W	85 cm				
		H	75 cm				
190 x 87	BASIC WITH LEGS BASIC AVEC PIEDS	L	195 cm	2,41 m <sup>3</sup>	28,5 Kg	300 Kg	10
		W	95 cm				
		H	130 cm				
	CENTER	L	195 cm				
		W	95 cm	1,39 m <sup>3</sup>	55 Kg	73 Kg	1
		H	75 cm				
SX1	L	195 cm					
		W	95 cm				
		H	75 cm	1,39 m <sup>3</sup>	70 Kg	81 Kg	1
SX5	L	195 cm					
		W	95 cm				
		H	75 cm				

# MINIMAL OVAL

bathubs - baignoires

## MINIMAL OVAL 175x80 cm.

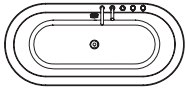

Water volume 195 l.  
Volume d'eau 195 l.

		FINISH FINITION	BRASSWARE ROBINETTERIE	SAP	KEA	€
<b>BASIC WITH LEGS BASIC AVEC PIEDS</b>			(1) - (2)	100057458	N710001156	1.057,00 €
			(3)	100060695	N710001155	2.169,00 €
<b>CENTER</b>			(4)	100057459	N710000134	1.950,00 €
			(3)	100060553	N710000183	3.238,00 €
<b>SX1</b>		built-in encastrement	(5)	100099093	N710000621	3.829,00 €
			(3)	100099094	N710000579	4.728,00 €
			(5)	100099091	N710000619	4.965,00 €
			(3)	100099092	N710000602	5.864,00 €
<b>SX5 (6)</b>			(5)	100099095	N710000556	7.178,00 €
			(3)	100099096	N710000562	8.077,00 €



<sup>(1)</sup> Including set of CASUAL universal support frame with feet • *Inclus châssis universelle CASUAL*



<sup>(2)</sup> Bath waste not included • *Vidage non inclus*

<sup>(3)</sup> Deck mounted bath filler set, Bath waste and overflow set included  
*Robinetterie avec bec sur plage, Vidage automatique inclus*



<sup>(4)</sup> Bath waste and overflow set included. Syphon not included • *Vidage automatique inclus. Siphon non inclus*

<sup>(5)</sup> Deck mounted bath filler set • *Robinetterie avec bec sur plage*

<sup>(6)</sup> Make sure that all the important equipment and LED lights can be easily accessed  
*Ne doit pas être encastrée sans possibilité d'accéder aux spots*

### ACCESSORIES • ACCESSOIRES

	DESCRIPTION DESCRIPTION	COLOUR COULEUR	SAP	KEA	€	BASIC	CENTER	SX1	SX5
	<sup>(1)</sup> Bath waste and overflow set NEXT + Syphon • <i>Vidage automatique NEXT + Syphon</i>		100060498	N780000002	51,00 €	✓			
	MILD head rest • <i>Appui-tête ENJOY</i>		100066187	N770000050	91,00 €	✓	✓	✓	✓
			100056383	N770000007	239,00 €				
	ENJOY head rest • <i>Appui-tête ENJOY</i>		100056384	N770000034	239,00 €	✓	✓	✓	✓
			100056387	N770000017	239,00 €				
	ENJOY "S" head rest • <i>Appui-tête ENJOY "S"</i>		100060780	N770000049	198,00 €				
			100060753	N770000065	198,00 €	✓	✓	✓	✓
			100060767	N770000057	198,00 €				
	<sup>(2)</sup> Bath access panel • <i>Trappe de visite baignoire</i>		250021559	N790001316	331,00 €			✓	
	<sup>(1)</sup> Bath trap NEXT D40 • <i>Siphon vidage pour baignoire NEXT D40</i>		100158208	N790001657	11,00 €	✓	✓		

<sup>(1)</sup> Only required for the models not including brassware • *Nécessaire uniquement pour les modèles sans robinetterie*

<sup>(2)</sup> Required for all built-in installations • *Nécessaire pour tous les modèles encastrés*

# MINIMAL OVAL

bathtubs - baignoires

## MINIMAL OVAL 190x87 cm.

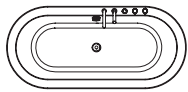

Water volume 238 l.  
Volume d'eau 238 l.

		FINISH FINITION	BRASSWARE ROBINETTERIE	SAP	KEA	€
<b>BASIC WITH LEGS BASIC AVEC PIEDS</b>			(1) - (2)	100096245	N710001157	1.215,00 €
			(3)	100096246	N710001158	2.573,00 €
<b>CENTER</b>			(4)	100096269	N710000487	2.846,00 €
			(3)	100096270	N710000390	4.169,00 €
<b>SX1</b>		built-in encastrement	(5)	100099099	N710000656	4.038,00 €
			(5)	100099100	N710000678	4.936,00 €
			(5)	100099097	N710000554	5.500,00 €
			(3)	100099098	N710000681	6.399,00 €
<b>SX5 (6)</b>			(5)	100099101	N710000620	7.712,00 €
			(3)	100099102	N710000704	8.611,00 €



<sup>(1)</sup> Including set of CASUAL universal support frame with feet • *Inclus châssis universelle*



<sup>(2)</sup> Bath waste not included • *Vidage non inclus*



<sup>(3)</sup> Deck mounted bath filler set, Bath waste and overflow set included  
*Robinetterie avec bec sur plage, Vidage automatique inclus*

<sup>(4)</sup> Bath waste and overflow set included. Syphon not included • *Vidage automatique inclus. Siphon non inclus*

<sup>(5)</sup> Deck mounted bath filler set • *Robinetterie avec bec sur plage*

<sup>(6)</sup> Make sure that all the important equipment and LED lights can be easily accessed  
*Ne doit pas être encastrée sans possibilité d'accéder aux spots*

## ACCESSORIES • ACCESSOIRES

	DESCRIPTION DESCRIPTION	COLOUR COULEUR	SAP	KEA	€	BASIC	CENTER	SX1	SX5
	<sup>(1)</sup> Bath waste and overflow set NEXT + Syphon • <i>Vidage automatique NEXT + Syphon</i>		100060498	N780000002	51,00 €	✓			
	MILD head rest • <i>Appui-tête ENJOY</i>		100066187	N770000050	91,00 €	✓	✓	✓	✓
	ENJOY head rest • <i>Appui-tête ENJOY</i>		100056383	N770000007	239,00 €				
			100056384	N770000034	239,00 €	✓	✓	✓	✓
			100056387	N770000017	239,00 €				
	ENJOY "S" head rest • <i>Appui-tête ENJOY "S"</i>		100060780	N770000049	198,00 €				
			100060753	N770000065	198,00 €	✓	✓	✓	✓
			100060767	N770000057	198,00 €				
	<sup>(2)</sup> Bath access panel • <i>Trappe de visite baignoire</i>		250021559	N790001316	331,00 €			✓	
	<sup>(1)</sup> Bath trap NEXT D40 • <i>Siphon vidage pour baignoire NEXT D40</i>		100158208	N790001657	11,00 €	✓	✓		

<sup>(1)</sup> Only required for the models not including brassware • *Nécessaire uniquement pour les modèles sans robinetterie*

<sup>(2)</sup> Required for all built-in installations • *Nécessaire pour tous les modèles encastrés*

# SP ONE

bathtubs - baignoires



bathtubs / baignoires SP ONE

## COLOURS • COULEURS



CLUB panel  
tablier CLUB



white  
blanc



black  
noir



Inox



MODUL panel  
tablier MODUL



white  
blanc



chrome / white  
chromé / blanc



Chrome  
Chromé

## ACCESSORIES • ACCESSOIRES



ENJOY head rest  
Appui-tête ENJOY



ENJOY "S" head rest  
Appui-tête ENJOY "S"

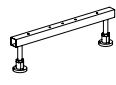

Set of universal support  
frame with feet  
Châssis universel avec  
pieds



CLUB panel  
tablier CLUB



MODUL panel  
tablier MODUL



access panel  
trappe de visite



bath waste and  
overflow set  
vidage automatique



bath filler waste and over-  
flow set  
automatique vidage bec  
verseur



deck mounted  
valves and  
handset  
robinetterie

## SIZES cm. • FORMATS cm.

140x70 • 61h  
150x70 • 61h  
160x70 • 61h  
160x75 • 61h

## EQUIPMENT • EQUIPEMENT

	
JETS	6

See features on page 22-25.  
Consultez caractéristiques en page 22-25.



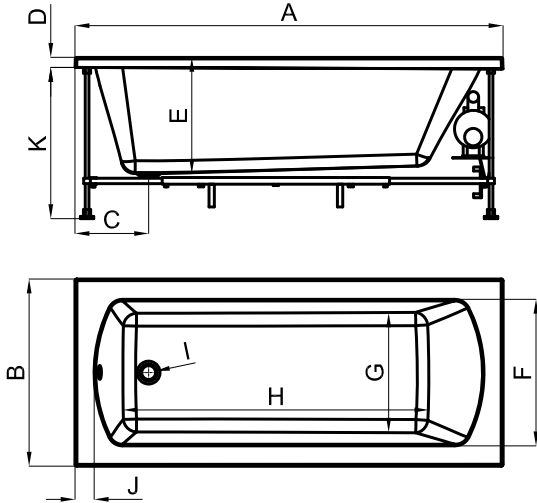

## DRAWINGS mm. • PLANS mm.

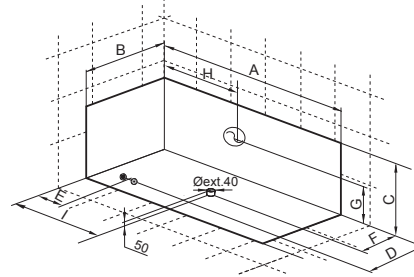
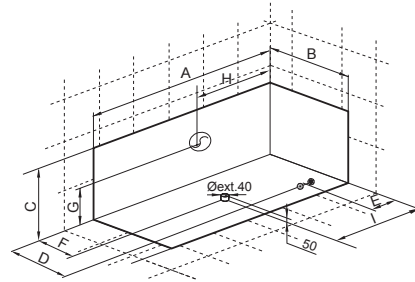

mm	A	B	C	D	E	F	G	H	I	J	K
1400 x 700	1400	700	290	45	430	540	445	940	ø52	70	565
1500 x 700	1500	700	290	45	430	540	445	1040	ø52	70	565
1600 x 700	1600	700	290	45	430	540	445	1140	ø52	70	565
1600 x 750	1600	750	290	45	430	590	495	1140	ø52	70	565

## PRE-INSTALLING • PRE-INSTALLATION



	Hot water connections Prise d'eau chaude
	Cold water connections Prise d'eau froide
	Waste Vidage
	Electrical connections Câblage électrique

mm	A	B	C	D	E	F	G	H	I
1400 x 700	1400	700	610	465	250	350	300	700	350
1500 x 700	1500	700	610	465	250	350	300	750	350
1600 x 700	1600	700	610	465	250	350	300	800	400
1600 x 750	1600	750	610	500	250	375	300	800	400

## PACKAGING DETAILS • DONNÉES D'EXPÉDITION

		DIMENSIONS DIMENSIONS	VOLUME VOLUME	NET WEIGHT / PIECE POIDS NET / PIÈCE	GROSS WEIGHT / PALLET POIDS BRUT / PALETTE	PIECES / PALLET PIÈCES / PALETTE
140 x 70	BASIC	L 125 cm W 72 cm H 160 cm	1,44 m³	19 Kg	305 Kg	15
	BATH WITH FRAME CHASSIS SANS HYDROMAS- SAGE	L 144 cm W 74 cm H 69 cm	0,74 m³	22,1 Kg	31,1 Kg	1
	S0	L 144 cm W 74 cm H 69 cm	0,74 m³	30,3 Kg	39,3 Kg	1
150 x 70	BASIC	L 125 cm W 72 cm H 170 cm	1,53 m³	21,5 Kg	342,5 Kg	15
	BATH WITH FRAME CHASSIS SANS HYDROMAS- SAGE	L 154 cm W 74 cm H 69 cm	0,79 m³	24,8 Kg	34,3 Kg	1
	S0	L 154 cm W 74 cm H 69 cm	0,79 m³	33 Kg	42,5 Kg	1
160 x 70	BASIC	L 125 cm W 77 cm H 180 cm	1,73 m³	22 Kg	350 Kg	15
	BATH WITH FRAME CHASSIS SANS HYDROMAS- SAGE	L 164 cm W 79 cm H 69 cm	0,89 m³	25,4 Kg	35,4 Kg	1
	S0	L 164 cm W 79 cm H 69 cm	0,89 m³	33,6 Kg	43,6 Kg	1
160 x 75	BASIC	L 125 cm W 77 cm H 180 cm	1,73 m³	23 Kg	365 Kg	15
	BATH WITH FRAME CHASSIS SANS HYDROMAS- SAGE	L 164 cm W 79 cm H 69 cm	0,89 m³	26,5 Kg	36,5 Kg	1
	S0	L 164 cm W 79 cm H 69 cm	0,89 m³	34,7 Kg	44,7 Kg	1

## SP ONE 140x70 cm.

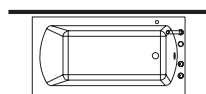

left  
gauche

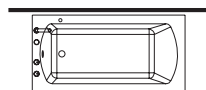

right  
droite

		FINISH FINITION	BRASSWARE ROBINETTERIE	SAP	KEA	€
<b>BASIC</b>		(1)		100057450	N710000145	420,00 €
		(2)		100060003	N710000158	1.418,00 €
<b>BATH WITH FRAME CHASSIS SANS HYDROMAS- SAGE</b>		(1)		100060004	N710000160	937,00 €
		(2)		100060005	N710000233	1.936,00 €
<b>S0</b>		right droite	(1)	100060006	N710000196	1.979,00 €
			(2)		100060007	N710000169
		left gauche	(1)	100060008	N710000157	1.979,00 €
			(2)		100060009	N710000140

Water volume 147 l.  
Volume d'eau 147 l.



<sup>(1)</sup> Bath waste not included • Vidage non inclus

<sup>(2)</sup> Bath waste and overflow set included with filler • Vidage automatique avec bec verseur

## ACCESSORIES • ACCESSOIRES

	DESCRIPTION DESCRIPTION	COLOUR COULEUR	SAP	KEA	€	BASIC	FRAME CHASSIS	S0
	<sup>(1)</sup> Bath waste and overflow set NEXT + Syphon • Vidage automatique NEXT + Syphon		100060498	N780000002	51,00 €	✓	✓	✓
	<sup>(1)</sup> NEXT bath filler waste and overflow set including bath trap • Vidage NEXT avec bec verseur + Syphon		100060521	N780000008	130,00 €	✓	✓	
	COLD head rest • Appui-tête COLD		100066186	N770000052	91,00 €	✓	✓	✓
	ENJOY head rest • Appui-tête ENJOY		100056383	N770000007	239,00 €			
			100056384	N770000034	239,00 €	✓	✓	✓
			100056387	N770000017	239,00 €			
	ENJOY "S" head rest • Appui-tête ENJOY "S"		100060780	N770000049	198,00 €			
			100060753	N770000065	198,00 €	✓	✓	✓
			100060767	N770000057	198,00 €			
	Set of CASUAL PLUS support frame with feet • Kit châssis universel CASUAL PLUS		100057508	N770000042	39,00 €	✓		
	<sup>(2)</sup> Bath access panel • Trappe de visite baignoire		250021559	N790001316	331,00 €	✓	✓	✓
	MODUL panel 140 • 140 Tablier MODUL		100060327	N770000060	188,00 €		✓	✓
	MODUL panel 70 • 70 tablier MODUL		100056218	N770000152	111,00 €		✓	✓
	CLUB panel 140 • 140 Tablier CLUB		100060696	N770000123	311,00 €			
			100060698	N770000125	333,00 €		✓	✓
			100060697	N770000126	358,00 €			
			100056075	N770000113	176,00 €			
	CLUB panel 70 • 70 Tablier CLUB		100056077	N770000132	191,00 €		✓	✓
			100056076	N770000114	203,00 €			

<sup>(1)</sup> Only required for the models not including brassware • Nécessaire uniquement pour les modèles sans robinetterie

<sup>(2)</sup> Required for all built-in installations • Nécessaire pour tous les modèles encastrés

## SP ONE 150x70 cm.

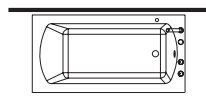

left  
gauche

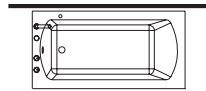

right  
droite

		FINISH FINITION	BRASSWARE ROBINETTERIE	SAP	KEA	€
<b>BASIC</b>		(1)		100057451	N710000229	427,00 €
		(2)		100060010	N710000283	1.444,00 €
<b>BATH WITH FRAME CHASSIS SANS HYDROMAS- SAGE</b>		(1)		100060011	N710000136	942,00 €
		(2)		100060012	N710000154	1.919,00 €
<b>S0</b>		right droite	(1)	100060013	N710000178	2.004,00 €
			(2)		100060014	N710000130
		left gauche	(1)	100060015	N710000138	2.004,00 €
			(2)		100060016	N710000185

Water volume 160 l.  
Volume d'eau 160 l.



<sup>(1)</sup> Bath waste not included • Vidage non inclus

<sup>(2)</sup> Bath waste and overflow set included with filler • Vidage automatique avec bec verseur

## ACCESSORIES • ACCESSOIRES

	DESCRIPTION DESCRIPTION	COLOUR COULEUR	SAP	KEA	€	BASIC	FRAME CHASSIS	S0
	<sup>(1)</sup> Bath waste and overflow set NEXT + Syphon • Vidage automatique NEXT + Syphon		100060498	N780000002	51,00 €	✓	✓	✓
	<sup>(1)</sup> NEXT bath filler waste and overflow set including bath trap • Vidage NEXT avec bec verseur + Syphon		100060521	N780000008	130,00 €	✓	✓	
	COLD head rest • Appui-tête COLD		100066186	N770000052	91,00 €	✓	✓	✓
	ENJOY head rest • Appui-tête ENJOY		100056383	N770000007	239,00 €			
			100056384	N770000034	239,00 €	✓	✓	✓
	ENJOY "S" head rest • Appui-tête ENJOY "S"		100060780	N770000049	198,00 €			
			100060753	N770000065	198,00 €	✓	✓	✓
			100060767	N770000057	198,00 €			
	Set of CASUAL PLUS support frame with feet • Kit châssis universel CASUAL PLUS		100057508	N770000042	39,00 €	✓		
	<sup>(2)</sup> Bath access panel • Trappe de visite baignoire		250021559	N790001316	331,00 €	✓	✓	✓
	MODUL panel 150 • 150 Tablier MODUL		100056221	N770000156	188,00 €		✓	✓
	MODUL panel 70 • 70 tablier MODUL		100056218	N770000152	111,00 €		✓	✓
	CLUB panel 150 • 150 Tablier CLUB		100056090	N770000139	326,00 €			
			100056092	N770000143	350,00 €		✓	✓
			100056091	N770000128	375,00 €			
			100056075	N770000113	176,00 €			
	CLUB panel 70 • 70 Tablier CLUB		100056077	N770000132	191,00 €		✓	✓
			100056076	N770000114	203,00 €			

<sup>(1)</sup> Only required for the models not including brassware • Nécessaire uniquement pour les modèles sans robinetterie

<sup>(2)</sup> Required for all built-in installations • Nécessaire pour tous les modèles encastrés

## SP ONE 160x70 cm.

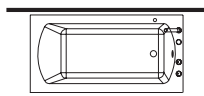

left  
gauche

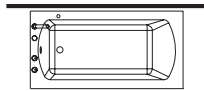

right  
droite

		FINISH FINITION	BRASSWARE ROBINETTERIE	SAP	KEA	€
<b>BASIC</b>		(1)		100057452	N710000217	433,00 €
		(2)		100060017	N710000176	1.456,00 €
<b>BATH WITH FRAME CHASSIS SANS HYDROMAS- SAGE</b>		(1)		100060018	N710000162	954,00 €
		(2)		100060019	N710000128	1.953,00 €
<b>S0</b>		right droite	(1)	100060020	N710000142	2.038,00 €
			(2)		100060021	N710000148
		left gauche	(1)	100060022	N710000147	2.038,00 €
			(2)		100060023	N710000211

Water volume 174 l.  
Volume d'eau 174 l.



<sup>(1)</sup> Bath waste not included • Vidage non inclus

<sup>(2)</sup> Bath waste and overflow set included with filler • Vidage automatique avec bec verseur

## ACCESSORIES • ACCESSOIRES

	DESCRIPTION DESCRIPTION	COLOUR COULEUR	SAP	KEA	€	BASIC	FRAME CHASSIS	S0
	<sup>(1)</sup> Bath waste and overflow set NEXT + Syphon • Vidage automatique NEXT + Syphon		100060498	N780000002	51,00 €	✓	✓	✓
	<sup>(1)</sup> NEXT bath filler waste and overflow set including bath trap • Vidage NEXT avec bec verseur + Syphon		100060521	N780000008	130,00 €	✓	✓	
	COLD head rest • Appui-tête COLD		100066186	N770000052	91,00 €	✓	✓	✓
	ENJOY head rest • Appui-tête ENJOY		100056383	N770000007	239,00 €			
			100056384	N770000034	239,00 €	✓	✓	✓
	ENJOY "S" head rest • Appui-tête ENJOY "S"		100060780	N770000049	198,00 €			
			100060753	N770000065	198,00 €	✓	✓	✓
			100060767	N770000057	198,00 €			
	Set of CASUAL PLUS support frame with feet • Kit châssis universel CASUAL PLUS		100057508	N770000042	39,00 €	✓		
	<sup>(2)</sup> Bath access panel • Trappe de visite baignoire		250021559	N790001316	331,00 €	✓	✓	✓
	MODUL panel 160 • 160 Tablier MODUL		100056215	N770000002	188,00 €		✓	✓
	MODUL panel 70 • 70 tablier MODUL		100056218	N770000152	111,00 €		✓	✓
	CLUB panel 160 • 160 Tablier CLUB		100056093	N770000121	331,00 €			
			100056095	N770000135	356,00 €		✓	✓
			100056094	N770000138	384,00 €			
			100056075	N770000113	176,00 €			
	CLUB panel 70 • 70 Tablier CLUB		100056077	N770000132	191,00 €		✓	✓
			100056076	N770000114	203,00 €			

<sup>(1)</sup> Only required for the models not including brassware • Nécessaire uniquement pour les modèles sans robinetterie

<sup>(2)</sup> Required for all built-in installations • Nécessaire pour tous les modèles encastrés



## SP ONE 160x75 cm.

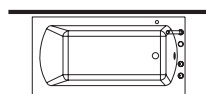

left  
gauche

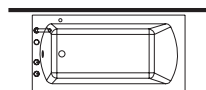

right  
droite

		FINISH FINITION	BRASSWARE ROBINETTERIE	SAP	KEA	€
<b>BASIC</b>		(1)		100057453	N710000152	460,00 €
		(2)		100060024	N710000182	1.472,00 €
<b>BATH WITH FRAME CHASSIS SANS HYDROMASSAGE</b>		(1)		100060025	N710000166	988,00 €
		(2)		100060026	N710000184	1.970,00 €
<b>S0</b>		right droite	(1)	100060027	N710000156	2.054,00 €
			(2)		100060028	N710000278
		left gauche	(1)	100060029	N710000289	2.054,00 €
			(2)		100060030	N710000227

Water volume 183 l.  
Volume d'eau 183 l.



<sup>(1)</sup> Bath waste not included • Vidage non inclus

<sup>(2)</sup> Bath waste and overflow set included with filler • Vidage automatique avec bec verseur

## ACCESSORIES • ACCESSOIRES

	DESCRIPTION DESCRIPTION	COLOUR COULEUR	SAP	KEA	€	BASIC	FRAME CHASSIS	S0
	<sup>(1)</sup> Bath waste and overflow set NEXT + Syphon • Vidage automatique NEXT + Syphon		100060498	N780000002	51,00 €	✓	✓	✓
	<sup>(1)</sup> NEXT bath filler waste and overflow set including bath trap • Vidage NEXT avec bec verseur + Syphon		100060521	N780000008	130,00 €	✓	✓	
	COLD head rest • Appui-tête COLD		100066186	N770000052	91,00 €	✓	✓	✓
	ENJOY head rest • Appui-tête ENJOY		100056383	N770000007	239,00 €			
			100056384	N770000034	239,00 €	✓	✓	✓
	ENJOY "S" head rest • Appui-tête ENJOY "S"		10006780	N770000049	198,00 €			
			10006753	N770000065	198,00 €	✓	✓	✓
			10006767	N770000057	198,00 €			
	Set of CASUAL PLUS support frame with feet • Kit châssis universel CASUAL PLUS		100057508	N770000042	39,00 €	✓		
	<sup>(2)</sup> Bath access panel • Trappe de visite baignoire		250021559	N790001316	331,00 €	✓	✓	✓
	MODUL panel 160 • 160 Tablier MODUL		100056215	N770000002	188,00 €		✓	✓
	MODUL panel 75 • 75 tablier MODUL		100056217	N770000157	111,00 €		✓	✓
	CLUB panel 160 • 160 Tablier CLUB		100056093	N770000121	331,00 €			
			100056095	N770000135	356,00 €		✓	✓
			100056094	N770000138	384,00 €			
			100056078	N770000116	180,00 €			
	CLUB panel 75 • 75 Tablier CLUB		100056080	N770000120	192,00 €		✓	✓
			100056079	N770000142	205,00 €			

<sup>(1)</sup> Only required for the models not including brassware • Nécessaire uniquement pour les modèles sans robinetterie

<sup>(2)</sup> Required for all built-in installations • Nécessaire pour tous les modèles encastrés

# SP ONE XL

bathtubs - baignoires



bathtubs / baignoires SP ONE XL

## COLOURS • COULEURS



CLUB panel  
tablier CLUB



white  
blanc



black  
noir



Inox



MODUL panel  
tablier MODUL



white  
blanc



chrome / white  
chromé / blanc



Chrome  
Chromé

## ACCESSORIES • ACCESSOIRES



ENJOY head rest  
Appui-tête ENJOY



ENJOY "S" head rest  
Appui-tête ENJOY "S"

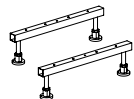

Set of universal support  
frame with feet  
Châssis universel avec  
pieds



CLUB panel  
tablier CLUB



MODUL panel  
tablier MODUL



access panel  
trappe de visite



bath waste and  
overflow set  
vidage automatique



bath filler waste and over-  
flow set  
automatique vidage bec  
verseur



deck mounted  
valves and  
handset  
robinetterie

## SIZES cm. • FORMATS cm.

170x70 • 61h  
170x75 • 61h  
180x80 • 61h  
180x90 • 61h

# SP ONE XL

bathubs - baignoires

## EQUIPMENT • EQUIPEMENT

	
	S0
JETS	6

See features on page 22-25.

Consultez caractéristiques en page 22-25.



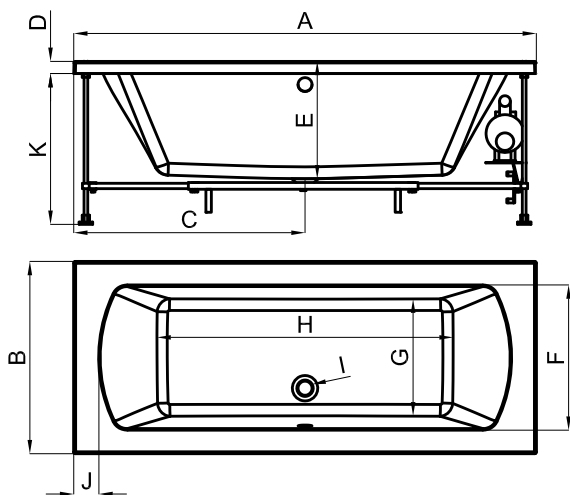

## DRAWINGS mm. • PLANS mm.

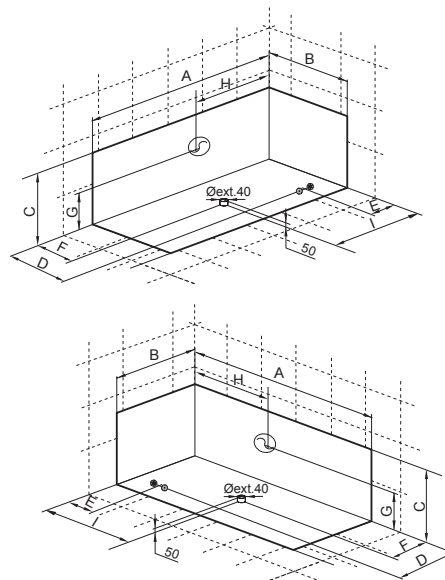

mm	A	B	C	D	E	F	G	H	I	J	K
1700x700	1700	700	850	45	430	540	445	1095	ø52	70	565
1700x750	1700	750	850	45	430	590	495	1095	ø52	70	565
1800x800	1800	800	900	45	430	640	545	1195	ø52	70	565
1800x900	1800	900	900	45	430	740	645	1195	ø52	70	565

## PRE-INSTALLING • PRE-INSTALLATION



	Hot water connections Prise d'eau chaude
	Cold water connections Prise d'eau froide
	Waste Vidage
	Electrical connections Câblage électrique

mm	A	B	C	D	E	F	G	H	I
1700x700	1700	700	610	450	250	350	300	850	850
1700x750	1700	750	610	500	250	375	300	850	850
1800x800	1800	800	610	550	250	400	300	900	900
1800x900	1800	900	610	650	250	450	300	950	950

## PACKAGING DETAILS • DONNÉES D'EXPÉDITION

		DIMENSIONS DIMENSIONS	VOLUME VOLUME	NET WEIGHT / PIECE POIDS NET / PIÈCE	GROSS WEIGHT / PALLET POIDS BRUT / PALETTE	PIECES / PALLET PIÈCES / PALETTE
170 x 70	BASIC	L 125 cm W 77 cm H 190 cm	1,83 m³	24 Kg	380 Kg	15
	BATH WITH FRAME CHASSIS SANS HYDROMAS- SAGE	L 174 cm W 79 cm H 69 cm	0,95 m³	27,6 Kg	38,1 Kg	1
	S0	L 174 cm W 79 cm H 69 cm	0,95 m³	35,8 Kg	46,3 Kg	1
170 x 75	BASIC	L 125 cm W 77 cm H 190 cm	1,83 m³	25,5 Kg	402,5 Kg	15
	BATH WITH FRAME CHASSIS SANS HYDROMAS- SAGE	L 174 cm W 79 cm H 69 cm	0,95 m³	29,2 Kg	39,7 Kg	1
	S0	L 174 cm W 79 cm H 69 cm	0,95 m³	37,4 Kg	47,9 Kg	1
180 x 80	BASIC	L 125 cm W 82 cm H 200 cm	2,05 m³	30 Kg	470 Kg	15
	BATH WITH FRAME CHASSIS SANS HYDROMAS- SAGE	L 184 cm W 84 cm H 69 cm	1,07 m³	33,9 Kg	45,4 Kg	1
	S0	L 184 cm W 84 cm H 69 cm	1,07 m³	42,1 Kg	53,6 Kg	1
180 x 90	BASIC	L 125 cm W 92 cm H 200 cm	2,3 m³	32,5 Kg	507,5 Kg	15
	BATH WITH FRAME CHASSIS SANS HYDROMAS- SAGE	L 194 cm W 94 cm H 69 cm	1,26 m³	36,5 Kg	49 Kg	1
	S0	L 194 cm W 94 cm H 69 cm	1,26 m³	44,7 Kg	57,2 Kg	1

# SP ONE XL

bathtubs - baignoires

## SP ONE XL 170x70 cm.

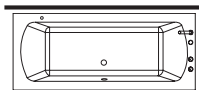
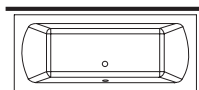

left  
gauche

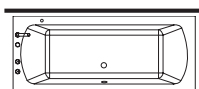

right  
droite

		FINISH FINITION	BRASSWARE ROBINETTERIE	SAP	KEA	€
<b>BASIC</b>		(1)		100057454	N710000133	442,00 €
		(2)		100060031	N710000150	1.457,00 €
<b>BATH WITH FRAME CHASSIS SANS HYDROMAS- SAGE</b>		(1)		100060032	N710000168	992,00 €
		(2)		100060033	N710000174	1.953,00 €
<b>S0</b>		(1)		100060034	N710000239	2.038,00 €
		right droite	(2)	100060035	N710000199	3.066,00 €
		left gauche	(2)	100060036	N710000201	3.066,00 €

Water volume 174 l.  
Volume d'eau 174 l.



<sup>(1)</sup> Bath waste not included • Vidage non inclus

<sup>(2)</sup> Bath waste and overflow set included with filler • Vidage automatique avec bec verseur

## ACCESSORIES • ACCESSOIRES

	DESCRIPTION DESCRIPTION	COLOUR COULEUR	SAP	KEA	€	BASIC	FRAME CHASSIS	S0
	<sup>(1)</sup> Bath waste and overflow set NEXT + Syphon • Vidage automatique NEXT + Syphon		100060498	N780000002	51,00 €	✓	✓	✓
	<sup>(1)</sup> NEXT bath filler waste and overflow set including bath trap • Vidage NEXT avec bec verseur + Syphon		100060521	N780000008	130,00 €	✓	✓	✓
	COLD head rest • Appui-tête COLD		100066186	N770000052	91,00 €	✓	✓	✓
	ENJOY head rest • Appui-tête ENJOY		100056383	N770000007	239,00 €			
			100056384	N770000034	239,00 €	✓	✓	✓
			100056387	N770000017	239,00 €			
	ENJOY "S" head rest • Appui-tête ENJOY "S"		100060780	N770000049	198,00 €			
			100060753	N770000065	198,00 €	✓	✓	✓
			100060767	N770000057	198,00 €			
	Set of CASUAL universal support frame with feet CASUAL • Kit chassie universel CASUAL		100057508	N770000042	39,00 €	✓		
	<sup>(2)</sup> Bath access panel • Trappe de visite baignoire		250021559	N790001316	331,00 €	✓	✓	✓
	MODUL panel 170 • 170 Tablier MODUL		100056216	N770000146	188,00 €		✓	✓
	MODUL panel 70 • 70 tablier MODUL		100056218	N770000152	111,00 €		✓	✓
	CLUB panel 170 • 170 Tablier CLUB		100056096	N770000144	341,00 €			
			100056098	N770000140	368,00 €		✓	✓
			100056097	N770000145	398,00 €			
			100056075	N770000113	176,00 €			
	CLUB panel 70 • 70 Tablier CLUB		100056077	N770000132	191,00 €		✓	✓
			100056076	N770000114	203,00 €			

<sup>(1)</sup> Only required for the models not including brassware • Nécessaire uniquement pour les modèles sans robinetterie

<sup>(2)</sup> Required for all built-in installations • Nécessaire pour tous les modèles encastrés

# SP ONE XL

bathtubs - baignoires

## SP ONE XL 170x75 cm.

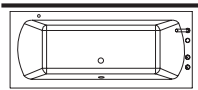
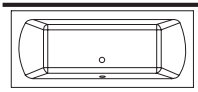

left  
gauche

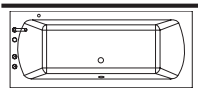

right  
droite

		FINISH FINITION	BRASSWARE ROBINETTERIE	SAP	KEA	€	
<b>BASIC</b>		(1)		100057455	N710000155	440,00 €	
		(2)		100060037	N710000258	1.473,00 €	
<b>BATH WITH FRAME CHASSIS SANS HYDROMAS- SAGE</b>		(1)		100060038	N710000202	1.009,00 €	
		(2)		100060039	N710000208	1.970,00 €	
<b>S0</b>		(1)		100060040	N710000215	2.054,00 €	
		right droite	(2)		100060041	N710000273	3.083,00 €
		left gauche	(2)		100060042	N710000242	3.083,00 €

Water volume 194 l.  
Volume d'eau 194 l.



<sup>(1)</sup> Bath waste not included • Vidage non inclus

<sup>(2)</sup> Bath waste and overflow set included with filler • Vidage automatique avec bec verseur

## ACCESSORIES • ACCESSOIRES

	DESCRIPTION DESCRIPTION	COLOUR COULEUR	SAP	KEA	€	BASIC	FRAME CHASSIS	S0
	<sup>(1)</sup> Bath waste and overflow set NEXT + Syphon • Vidage automatique NEXT + Syphon		100060498	N780000002	51,00 €	✓	✓	✓
	<sup>(1)</sup> NEXT bath filler waste and overflow set including bath trap • Vidage NEXT avec bec verseur + Syphon		100060521	N780000008	130,00 €	✓	✓	✓
	COLD head rest • Appui-tête COLD		100066186	N770000052	91,00 €	✓	✓	✓
	ENJOY head rest • Appui-tête ENJOY		100056383	N770000007	239,00 €			
			100056384	N770000034	239,00 €	✓	✓	✓
	ENJOY "S" head rest • Appui-tête ENJOY "S"		100056387	N770000017	239,00 €			
			100060780	N770000049	198,00 €			
			100060753	N770000065	198,00 €	✓	✓	✓
		100060767	N770000057	198,00 €				
	Set of CASUAL universal support frame with feet CASUAL • Kit chassis universel CASUAL		100057508	N770000042	39,00 €	✓		
	<sup>(2)</sup> Bath access panel • Trappe de visite baignoire		250021559	N790001316	331,00 €	✓	✓	✓
	MODUL panel 170 • 170 Tablier MODUL		100056216	N770000146	188,00 €		✓	✓
	MODUL panel 75 • 75 tablier MODUL		100056217	N770000157	111,00 €		✓	✓
	CLUB panel 170 • 170 Tablier CLUB		100056096	N770000144	341,00 €			
			100056098	N770000140	368,00 €		✓	✓
			100056097	N770000145	398,00 €			
			100056078	N770000116	180,00 €			
	CLUB panel 75 • 75 Tablier CLUB		100056080	N770000120	192,00 €		✓	✓
			100056079	N770000142	205,00 €			

<sup>(1)</sup> Only required for the models not including brassware • Nécessaire uniquement pour les modèles sans robinetterie

<sup>(2)</sup> Required for all built-in installations • Nécessaire pour tous les modèles encastrés

# SP ONE XL

bathtubs - baignoires

## SP ONE XL 180x80 cm.

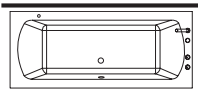
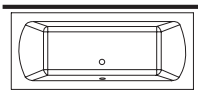

left  
gauche

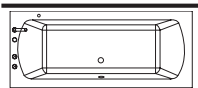

right  
droite

		FINISH FINITION	BRASSWARE ROBINETTERIE	SAP	KEA	€	
<b>BASIC</b>		(1)		100057456	N710000192	563,00 €	
		(2)		100060043	N710000172	1.532,00 €	
<b>BATH WITH FRAME CHASSIS SANS HYDROMAS- SAGE</b>		(1)		100060044	N710000224	1.086,00 €	
		(2)		100060045	N710000170	1.995,00 €	
<b>S0</b>		(1)		100060046	N710000206	2.117,00 €	
		right droite	(2)		100060047	N710000149	3.040,00 €
		left gauche	(2)		100060048	N710000143	3.040,00 €

Water volume 215 l.  
Volume d'eau 215 l.



<sup>(1)</sup> Bath waste not included • Vidage non inclus

<sup>(2)</sup> Bath waste and overflow set included with filler • Vidage automatique avec bec verseur

## ACCESSORIES • ACCESSOIRES

	DESCRIPTION DESCRIPTION	COLOUR COULEUR	SAP	KEA	€	BASIC	FRAME CHASSIS	S0
	<sup>(1)</sup> Bath waste and overflow set NEXT + Syphon • Vidage automatique NEXT + Syphon		100060498	N780000002	51,00 €	✓	✓	✓
	<sup>(1)</sup> NEXT bath filler waste and overflow set including bath trap • Vidage NEXT avec bec verseur + Syphon		100060521	N780000008	130,00 €	✓	✓	✓
	COLD head rest • Appui-tête COLD		100066186	N770000052	91,00 €	✓	✓	✓
	ENJOY head rest • Appui-tête ENJOY		100056383	N770000007	239,00 €			
			100056384	N770000034	239,00 €	✓	✓	✓
	ENJOY "S" head rest • Appui-tête ENJOY "S"		100056387	N770000017	239,00 €			
			100060780	N770000049	198,00 €			
	ENJOY "S" head rest • Appui-tête ENJOY "S"		100060753	N770000065	198,00 €	✓	✓	✓
			100060767	N770000057	198,00 €			
	Set of CASUAL PLUS support frame with feet • Kit châssis universel CASUAL PLUS		100060499	N770000066	49,00 €	✓		
	<sup>(2)</sup> Bath access panel • Trappe de visite baignoire		250021559	N790001316	331,00 €	✓	✓	✓
	MODUL panel 180 • 180 Tablier MODUL		100056222	N770000153	220,00 €		✓	✓
	MODUL panel 80 • 80 tablier MODUL		100056219	N770000150	111,00 €		✓	✓
	CLUB panel 180 • 180 Tablier CLUB		100056099	N770000130	354,00 €			
			100056101	N770000133	383,00 €		✓	✓
			100056100	N770000118	414,00 €			
	CLUB panel 80 • 80 Tablier CLUB		100056081	N770000117	184,00 €			
			100056083	N770000136	196,00 €		✓	✓
			100056082	N770000124	211,00 €			

<sup>(1)</sup> Only required for the models not including brassware • Nécessaire uniquement pour les modèles sans robinetterie

<sup>(2)</sup> Required for all built-in installations • Nécessaire pour tous les modèles encastrés

# SP ONE XL

bathtubs - baignoires

## SP ONE XL 180x90 cm.

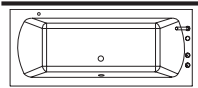
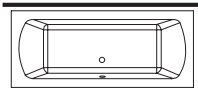

left  
gauche

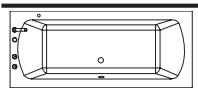

right  
droite

		FINISH FINITION	BRASSWARE ROBINETTERIE	SAP	KEA	€	
<b>BASIC</b>		(1)		100060049	N710000167	692,00 €	
		(2)		100060050	N710000164	1.698,00 €	
<b>BATH WITH FRAME CHASSIS SANS HYDROMAS- SAGE</b>		(1)		100060051	N710000207	1.257,00 €	
		(2)		100060052	N710000272	2.126,00 €	
<b>S0</b>		(1)		100060053	N710000146	2.251,00 €	
		right droite	(2)		100060054	N710000190	3.244,00 €
		left gauche	(2)		100060055	N710000220	3.244,00 €

Water volume 247 l.  
Volume d'eau 247 l.



<sup>(1)</sup> Bath waste not included • Vidage non inclus

<sup>(2)</sup> Bath waste and overflow set included with filler • Vidage automatique avec bec verseur

## ACCESSORIES • ACCESSOIRES

	DESCRIPTION DESCRIPTION	COLOUR COULEUR	SAP	KEA	€	BASIC	FRAME CHASSIS	S0
	<sup>(1)</sup> Bath waste and overflow set NEXT + Syphon • Vidage automatique NEXT + Syphon		100060498	N780000002	51,00 €	✓	✓	✓
	<sup>(1)</sup> NEXT bath filler waste and overflow set including bath trap • Vidage NEXT avec bec verseur + Syphon		100060521	N780000008	130,00 €	✓	✓	✓
	COLD head rest • Appui-tête COLD		100066186	N770000052	91,00 €	✓	✓	✓
	ENJOY head rest • Appui-tête ENJOY		100056383	N770000007	239,00 €			
			100056384	N770000034	239,00 €	✓	✓	✓
	ENJOY "S" head rest • Appui-tête ENJOY "S"		100056387	N770000017	239,00 €			
			100060780	N770000049	198,00 €			
			100060753	N770000065	198,00 €	✓	✓	✓
		100060767	N770000057	198,00 €				
	Set of CASUAL PLUS support frame with feet • Kit châssis universel CASUAL PLUS		100060499	N770000066	49,00 €	✓		
	<sup>(2)</sup> Bath access panel • Trappe de visite baignoire		250021559	N790001316	331,00 €	✓	✓	✓
	MODUL panel 180 • 180 Tablier MODUL		100056222	N770000153	220,00 €		✓	✓
	MODUL panel 90 • 90 tablier MODUL		100056220	N770000147	111,00 €		✓	✓
	CLUB panel 180 • 180 Tablier CLUB		100056099	N770000130	354,00 €			
			100056101	N770000133	383,00 €		✓	✓
			100056100	N770000118	414,00 €			
			100056084	N770000115	194,00 €			
	CLUB panel 90 • 90 Tablier CLUB		100056086	N770000137	208,00 €		✓	✓
			100056085	N770000119	224,00 €			

<sup>(1)</sup> Only required for the models not including brassware • Nécessaire uniquement pour les modèles sans robinetterie

<sup>(2)</sup> Required for all built-in installations • Nécessaire pour tous les modèles encastrés

# ECOLITE

bathtubs - baignoires



bathtubs / baignoires ECOLITE

## COLOURS • COULEURS



## ACCESSORIES • ACCESSOIRES

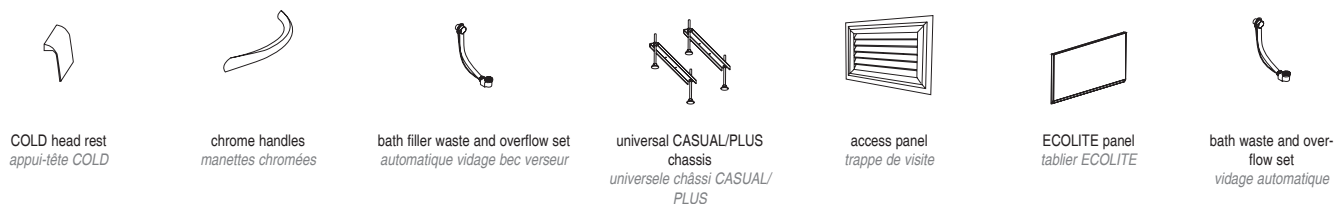

## SIZES cm. • FORMATS cm.

140x70 • 150x70 • 160x70 • 160x75 • 170x70 • 170x75 • 180x80 • 53h  
140x140 • 56,5h



## EQUIPMENT • EQUIPEMENT

	
	S0
JETS	6

See features on page 22-25.  
Consultez caracteristiques en page 22-25.

## DRAWINGS mm. • PLANS mm.

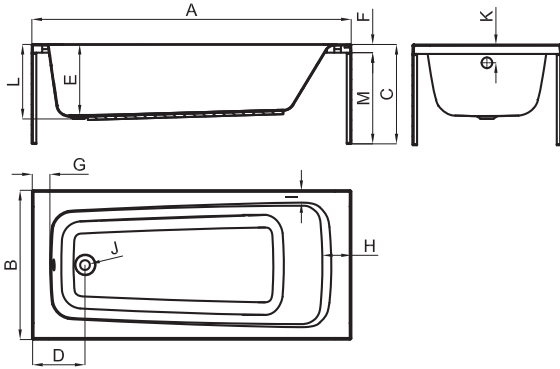

mm	A	B	C	D	E	F	G	H	I	J	K	L	M	N
1400x700	1400	700	530	250	380	45	90	120	70	Ø52	90	400	485	130
1500x700	1500	700	530	250	380	45	90	120	70	Ø52	90	400	485	130
1600x700	1600	700	530	250	380	45	90	120	70	Ø52	90	400	485	130
1600x750	1600	750	530	250	380	45	90	120	70	Ø52	90	400	485	130
1700x700	1700	700	530	250	380	45	90	120	70	Ø52	90	400	485	130
1700x750	1700	750	530	250	380	45	90	120	70	Ø52	90	400	485	130
1800x800	1800	800	530	250	380	45	90	120	70	Ø52	90	400	485	130

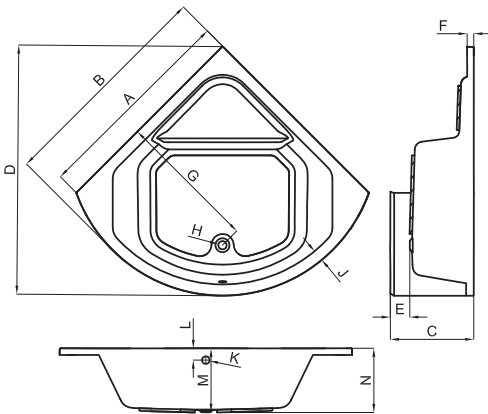



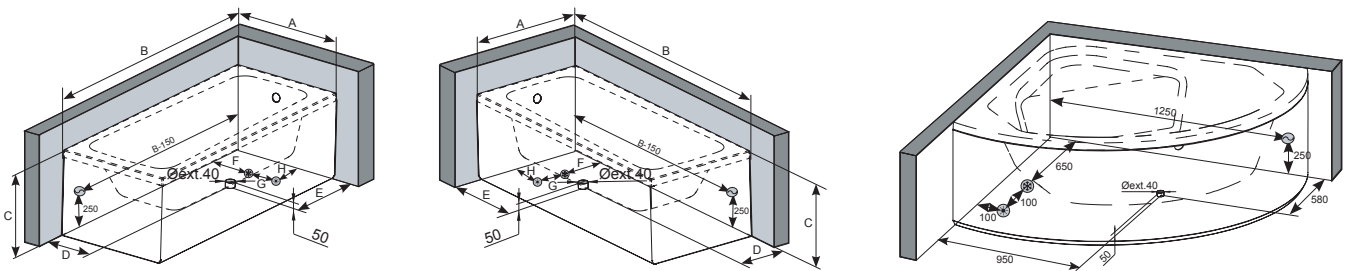

mm	A	B	C	D	E	F	G	H	I	J	K	L	M	N
1400x1400	1400	1500	565	1690	130	45	950	Ø52	1980	80	52	80	415	435

## PRE-INSTALLING • PRE-INSTALLATION



Left Gauche  
Right Droite

mm	A	B	C	D	E	F	G	H
1400x700	700	1400	535	350	600	500	100	100
1500x700	700	1500	535	350	600	500	100	100
1600x700	700	1600	535	350	600	500	100	100
1600x750	750	1600	535	375	600	500	100	100
1700x700	700	1700	535	350	600	500	100	100
1700x750	750	1700	535	375	600	500	100	100
1800x800	800	1800	535	400	600	500	100	100

	Hot water connections Prise d'eau chaude
	Cold water connections Prise d'eau froide
	Waste Vidage
	Electrical connections Câblage électrique

## PACKAGING DETAILS • DONNÉES D'EXPÉDITION

		DIMENSIONS DIMENSIONS		VOLUME VOLUME	NET WEIGHT / PIECE POIDS NET / PIÈCE	GROSS WEIGHT / PALLET POIDS BRUT / PALETTE	PIECES / PALLET PIÈCES / PALETTE
140x70	BASIC	L W H	120 cm 80 cm 160 cm	1,54 m <sup>3</sup>	19 Kg	248 Kg	12
	BATH WITH FRAME CHASSIS SANS HYDROMAS- SAGE	L W H	144 cm 74 cm 69 cm	0,74 m <sup>3</sup>	23,8 Kg	32,8 Kg	1
	S0	L W H	144 cm 74 cm 69 cm	0,74 m <sup>3</sup>	32,4 Kg	41,4 Kg	1
150x70	BASIC	L W H	120 cm 80 cm 170 cm	1,63 m <sup>3</sup>	21,5 Kg	278 Kg	12
	BATH WITH FRAME CHASSIS SANS HYDROMAS- SAGE	L W H	154 cm 74 cm 69 cm	0,79 m <sup>3</sup>	26,5 Kg	36 Kg	1
	S0	L W H	154 cm 74 cm 69 cm	0,79 m <sup>3</sup>	35,2 Kg	44,7 Kg	1
160x70	BASIC	L W H	120 cm 80 cm 180 cm	1,73 m <sup>3</sup>	23 Kg	296 Kg	12
	BATH WITH FRAME CHASSIS SANS HYDROMAS- SAGE	L W H	164 cm 79 cm 69 cm	0,89 m <sup>3</sup>	28,3 Kg	38,3 Kg	1
	S0	L W H	164 cm 79 cm 69 cm	0,89 m <sup>3</sup>	36,9 Kg	46,9 Kg	1
160x75	BASIC	L W H	120 cm 80 cm 180 cm	1,73 m <sup>3</sup>	24 Kg	308 Kg	12
	BATH WITH FRAME CHASSIS SANS HYDROMAS- SAGE	L W H	164 cm 79 cm 69 cm	0,89 m <sup>3</sup>	29,4 Kg	39,4 Kg	1
	S0	L W H	164 cm 79 cm 69 cm	0,89 m <sup>3</sup>	38 Kg	48 Kg	1
170x70	BASIC	L W H	120 cm 80 cm 190 cm	1,82 m <sup>3</sup>	26 Kg	384 Kg	14
	BATH WITH FRAME CHASSIS SANS HYDROMAS- SAGE	L W H	174 cm 79 cm 69 cm	0,95 m <sup>3</sup>	30 Kg	40,5 Kg	1
	S0	L W H	174 cm 79 cm 69 cm	0,95 m <sup>3</sup>	38,6 Kg	49,1 Kg	1
170x75	BASIC	L W H	120 cm 80 cm 190 cm	2,05 m <sup>3</sup>	27 Kg	344 Kg	12
	BATH WITH FRAME CHASSIS SANS HYDROMAS- SAGE	L W H	174 cm 79 cm 69 cm	0,95 m <sup>3</sup>	31,1 Kg	41,6 Kg	1
	S0	L W H	174 cm 79 cm 69 cm	0,95 m <sup>3</sup>	39,7 Kg	50,2 Kg	1
180x80	BASIC	L W H	120 cm 90 cm 200 cm	2,16 m <sup>3</sup>	29 Kg	368 Kg	12
	BATH WITH FRAME CHASSIS SANS HYDROMAS- SAGE	L W H	185 cm 85 cm 69 cm	1,08 m <sup>3</sup>	35 Kg	39 Kg	1
	S0	L W H	185 cm 85 cm 69 cm	1,08 m <sup>3</sup>	40 Kg	49 Kg	1
140x140	BASIC	L W H	152 cm 120 cm 160 cm	2,92 m <sup>3</sup>	32 Kg	404 Kg	12
	BATH WITH FRAME CHASSIS SANS HYDROMAS- SAGE	L W H	155 cm 155 cm 69 cm	1,65 m <sup>3</sup>	37 Kg	50 Kg	1
	S0	L W H	155 cm 155 cm 69 cm	1,65 m <sup>3</sup>	42 Kg	55 Kg	1

## ECOLITE 140x70 cm.

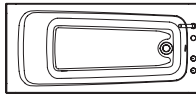

left  
gauche

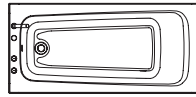

right  
droite

Water volume 116 l.  
Volume d'eau 116 l.

		POSITION POSITION	HANDLES MANETTES	BRASSWARE ROBINETTERIE	SAP	KEA	€
<b>BASIC</b>				(1)	100118916	N710000805	370,00 €
				(2)	100119079	N710000934	1.262,00 €
<b>BATH WITH FRAME CHASSIS SANS HYDROMAS- SAGE</b>				(1)	100119088	N710000984	704,00 €
				(2)	100119097	N710000889	1.617,00 €
				(1)	100119106	N710000742	826,00 €
				(2)	100119115	N710001023	1.758,00 €
<b>S0</b>		right droite		(1)	100119160	N710000905	1.709,00 €
				(2)	100119181	N710000843	2.567,00 €
				(1)	100119198	N710000935	1.853,00 €
		left gauche		(2)	100119214	N710000946	2.714,00 €
				(1)	100119161	N710000910	1.709,00 €
				(2)	100119182	N710000983	2.567,00 €
				(1)	100119199	N710000871	1.853,00 €
				(2)	100119215	N710000852	2.714,00 €



(1) Bath waste not included • Vidage non inclus

(2) Bath waste and overflow set included with filler • Vidage automatique avec bec verseur

## ACCESSORIES • ACCESSOIRES

	DESCRIPTION DESCRIPTION	COLOUR COULEUR	SAP	KEA	€	BASIC	FRAME CHASSIS	S0
	(1) Bath waste and overflow set NEXT + Syphon • Vidage automatique NEXT + Syphon		100060498	N780000002	51,00 €	✓	✓	✓
	(1) NEXT bath filler waste and overflow set including bath trap • Vidage NEXT avec bec verseur + Syphon		100060521	N780000008	130,00 €	✓	✓	✓
	COLD head rest • Appui-tête COLD		100066186	N770000052	91,00 €	✓	✓	✓
	Set of CASUAL universal support frame with feet CASUAL • Kit chassiss universel CASUAL		100057508	N770000042	39,00 €	✓		
	(2) Bath access panel • Trappe de visite baignoire		250021559	N790001316	331,00 €	✓	✓	✓
	Set of chrome grab handles • Kit manettes chromées		250017240	N790001283	98,00 €	✓		
	ECOLITE panel 140 • Tablier 140 ECOLITE		100118998	N770000081	218,00 €		✓	✓
	ECOLITE panel 70 • Tablier 70 ECOLITE		100108342	N770000079	209,00 €		✓	✓

(1) Only required for the models not including brassware • Nécessaire uniquement pour les modèles sans robinetterie

(2) Required for all built-in installations • Nécessaire pour tous les modèles encastrés

## ECOLITE 150x70 cm.

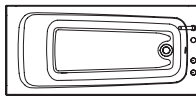

left  
gauche

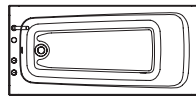

right  
droite

Water volume 128 l.  
Volume d'eau 128 l.

		POSITION POSITION	HANDLES MANETTES	BRASSWARE ROBINETTERIE	SAP	KEA	€
<b>BASIC</b>				(1)	100118917	N710000863	370,00 €
				(2)	100119080	N710000919	1.269,00 €
<b>BATH WITH FRAME CHASSIS SANS HYDROMAS- SAGE</b>				(1)	100119089	N710000800	705,00 €
				(2)	100119098	N710000782	1.622,00 €
				(1)	100119107	N710000893	823,00 €
				(2)	100119116	N710000767	1.762,00 €
<b>S0</b>		right droite		(1)	100119162	N710000877	1.712,00 €
				(2)	100119183	N710000879	2.585,00 €
				(1)	100119200	N710000731	1.856,00 €
		left gauche		(2)	100119216	N710000901	2.731,00 €
				(1)	100119163	N710000874	1.712,00 €
				(2)	100119184	N710000826	2.585,00 €
				(1)	100119201	N710000829	1.856,00 €
				(2)	100119217	N710001016	2.731,00 €



(1) Bath waste not included • Vidage non inclus

(2) Bath waste and overflow set included with filler • Vidage automatique avec bec verseur

## ACCESSORIES • ACCESSOIRES

	DESCRIPTION DESCRIPTION	COLOUR COULEUR	SAP	KEA	€	BASIC	FRAME CHASSIS	S0
	(1) Bath waste and overflow set NEXT + Syphon • Vidage automatique NEXT + Syphon		100060498	N780000002	51,00 €	✓	✓	✓
	(1) NEXT bath filler waste and overflow set including bath trap • Vidage NEXT avec bec verseur + Syphon		100060521	N780000008	130,00 €	✓	✓	✓
	COLD head rest • Appui-tête COLD		100066186	N770000052	91,00 €	✓	✓	✓
	Set of CASUAL universal support frame with feet CASUAL • Kit chassiss universel CASUAL		100057508	N770000042	39,00 €	✓		
	(2) Bath access panel • Trappe de visite baignoire		250021559	N790001316	331,00 €	✓	✓	✓
	Set of chrome grab handles • Kit manettes chromées		250017240	N790001283	98,00 €	✓		
	ECOLITE panel 150 • Tablier 150 ECOLITE		100118999	N770000076	218,00 €		✓	✓
	ECOLITE panel 70 • Tablier 70 ECOLITE		100108342	N770000079	209,00 €		✓	✓

(1) Only required for the models not including brassware • Nécessaire uniquement pour les modèles sans robinetterie

(2) Required for all built-in installations • Nécessaire pour tous les modèles encastrés

## ECOLITE 160x70 cm.

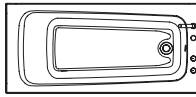

left  
gauche

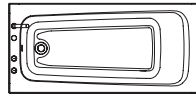

right  
droite

Water volume 139 l.  
Volume d'eau 139 l.

		POSITION POSITION	HANDLES MANETTES	BRASSWARE ROBINETTERIE	SAP	KEA	€
<b>BASIC</b>				(1)	100118918	N710001026	372,00 €
				(2)	100119081	N710000861	1.279,00 €
<b>BATH WITH FRAME CHASSIS SANS HYDROMAS- SAGE</b>				(1)	100119090	N710000953	707,00 €
				(2)	100119099	N710001002	1.624,00 €
				(1)	100119108	N710000887	824,00 €
				(2)	100119117	N710000921	1.762,00 €
<b>S0</b>		right droite		(1)	100119164	N710000922	1.719,00 €
				(2)	100119185	N710000981	2.604,00 €
				(1)	100119202	N710000815	1.859,00 €
		left gauche		(2)	100119218	N710001021	2.752,00 €
				(1)	100119165	N710000979	1.719,00 €
				(2)	100119186	N710000832	2.604,00 €
				(1)	100119203	N710000888	1.859,00 €
				(2)	100119219	N710000838	2.752,00 €



(1) Bath waste not included • Vidage non inclus

(2) Bath waste and overflow set included with filler • Vidage automatique avec bec verseur

## ACCESSORIES • ACCESSOIRES

	DESCRIPTION DESCRIPTION	COLOUR COULEUR	SAP	KEA	€	BASIC	FRAME CHASSIS	S0
	(1) Bath waste and overflow set NEXT + Syphon • Vidage automatique NEXT + Syphon		100060498	N780000002	51,00 €	✓	✓	✓
	(1) NEXT bath filler waste and overflow set including bath trap • Vidage NEXT avec bec verseur + Syphon		100060521	N780000008	130,00 €	✓	✓	✓
	COLD head rest • Appui-tête COLD		100066186	N770000052	91,00 €	✓	✓	✓
	Set of CASUAL universal support frame with feet CASUAL • Kit chassiss universel CASUAL		100057508	N770000042	39,00 €	✓		
	(2) Bath access panel • Trappe de visite baignoire		250021559	N790001316	331,00 €	✓	✓	✓
	Set of chrome grab handles • Kit manettes chromées		250017240	N790001283	98,00 €	✓		
	ECOLITE panel 160 • Tablier 160 ECOLITE		100119000	N770000077	227,00 €		✓	✓
	ECOLITE panel 70 • Tablier 70 ECOLITE		100108342	N770000079	209,00 €		✓	✓

(1) Only required for the models not including brassware • Nécessaire uniquement pour les modèles sans robinetterie

(2) Required for all built-in installations • Nécessaire pour tous les modèles encastrés

## ECOLITE 160x75 cm.

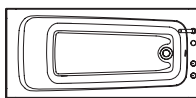

left  
gauche



right  
droite

Water volume 154 l.  
Volume d'eau 154 l.

		POSITION POSITION	HANDLES MANETTES	BRASSWARE ROBINETTERIE	SAP	KEA	€
<b>BASIC</b>				(1)	100118919	N710000918	373,00 €
				(2)	100119082	N710000881	1.288,00 €
<b>BATH WITH FRAME CHASSIS SANS HYDROMAS- SAGE</b>				(1)	100119091	N710000781	709,00 €
				(2)	100119100	N710000718	1.630,00 €
				(1)	100119109	N710001015	824,00 €
				(2)	100119118	N710000768	1.769,00 €
<b>S0</b>		right droite		(1)	100119166	N710000833	1.724,00 €
				(2)	100119187	N710000828	2.615,00 €
				(1)	100119204	N710000936	1.870,00 €
		left gauche		(2)	100119220	N710000926	2.762,00 €
				(1)	100119167	N710000727	1.724,00 €
				(2)	100119188	N710000897	2.615,00 €
				(1)	100119205	N710000891	1.870,00 €
				(2)	100119221	N710000878	2.762,00 €



(1) Bath waste not included • Vidage non inclus

(2) Bath waste and overflow set included with filler • Vidage automatique avec bec verseur

## ACCESSORIES • ACCESSOIRES

	DESCRIPTION DESCRIPTION	COLOUR COULEUR	SAP	KEA	€	BASIC	FRAME CHASSIS	S0	
	(1) Bath waste and overflow set NEXT + Syphon • Vidage automatique NEXT + Syphon		100060498	N780000002	51,00 €	✓	✓	✓	
	(1) NEXT bath filler waste and overflow set including bath trap • Vidage NEXT avec bec verseur + Syphon		100060521	N780000008	130,00 €	✓	✓	✓	
	COLD head rest • Appui-tête COLD		100066186	N770000052	91,00 €	✓	✓	✓	
	Set of CASUAL universal support frame with feet CASUAL • Kit chassiss universel CASUAL			100057508	N770000042	39,00 €	✓		
	(2) Bath access panel • Trappe de visite baignoire			250021559	N790001316	331,00 €	✓	✓	✓
	Set of chrome grab handles • Kit manettes chromées			250017240	N790001283	98,00 €	✓		
	ECOLITE panel 160 • Tablier 160 ECOLITE			100119000	N770000077	227,00 €		✓	✓
	ECOLITE panel 75 • Tablier 75 ECOLITE			100119002	N770000075	209,00 €		✓	✓

(1) Only required for the models not including brassware • Nécessaire uniquement pour les modèles sans robinetterie

(2) Required for all built-in installations • Nécessaire pour tous les modèles encastrés

## ECOLITE 170x70 cm.

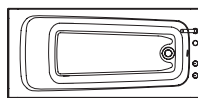

left  
gauche

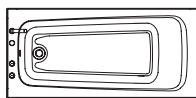

right  
droite

Water volume 150 l.  
Volume d'eau 150 l.

		POSITION POSITION	HANDLES MANETTES	BRASSWARE ROBINETTERIE	SAP	KEA	€
<b>BASIC</b>				(1)	100108331	N710000717	375,00 €
				(2)	100119083	N710000894	1.290,00 €
<b>BATH WITH FRAME CHASSIS SANS HYDROMAS- SAGE</b>				(1)	100119092	N710000849	710,00 €
				(2)	100119101	N710000902	1.632,00 €
				(1)	100119110	N710000914	826,00 €
				(2)	100119119	N710000812	1.770,00 €
<b>S0</b>		right droite		(1)	100119168	N710000836	1.728,00 €
				(2)	100119189	N710000974	2.617,00 €
				(1)	100119206	N710000870	1.872,00 €
		left gauche		(2)	100119222	N710000927	2.763,00 €
				(1)	100119169	N710000854	1.728,00 €
				(2)	100119190	N710000840	2.617,00 €
				(1)	100119207	N710000930	1.872,00 €
				(2)	100119223	N710000848	2.763,00 €



(1) Bath waste not included • Vidage non inclus  
(2) Bath waste and overflow set included with filler • Vidage automatique avec bec verseur

## ACCESSORIES • ACCESSOIRES

	DESCRIPTION DESCRIPTION	COLOUR COULEUR	SAP	KEA	€	BASIC	FRAME CHASSIS	S0
	(1) Bath waste and overflow set NEXT + Syphon • Vidage automatique NEXT + Syphon		100060498	N780000002	51,00 €	✓	✓	✓
	(1) NEXT bath filler waste and overflow set including bath trap • Vidage NEXT avec bec verseur + Syphon		100060521	N780000008	130,00 €	✓	✓	✓
	COLD head rest • Appui-tête COLD		100066186	N770000052	91,00 €	✓	✓	✓
	Set of CASUAL universal support frame with feet CASUAL • Kit chassiss universel CASUAL		100057508	N770000042	39,00 €	✓		
	(2) Bath access panel • Trappe de visite baignoire		250021559	N790001316	331,00 €	✓	✓	✓
	Set of chrome grab handles • Kit manettes chromées		250017240	N790001283	98,00 €	✓		
	ECOLITE panel 170 • Tablier 170 ECOLITE		100108340	N770000072	239,00 €		✓	✓
	ECOLITE panel 70 • Tablier 70 ECOLITE		100108342	N770000079	209,00 €		✓	✓

(1) Only required for the models not including brassware • Nécessaire uniquement pour les modèles sans robinetterie

(2) Required for all built-in installations • Nécessaire pour tous les modèles encastrés

## ECOLITE 170x75 cm.

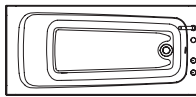

left  
gauche

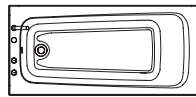

right  
droite

Water volume 166 l.  
Volume d'eau 166 l.

		POSITION POSITION	HANDLES MANETTES	BRASSWARE ROBINETTERIE	SAP	KEA	€
<b>BASIC</b>				(1)	100118920	N710000712	383,00 €
				(2)	100119084	N710000806	1.294,00 €
<b>BATH WITH FRAME CHASSIS SANS HYDROMAS- SAGE</b>				(1)	100119093	N710000908	719,00 €
				(2)	100119102	N710000739	1.639,00 €
				(1)	100119111	N710001054	835,00 €
				(2)	100119120	N710000880	1.776,00 €
<b>S0</b>		right droite		(1)	100119170	N710000890	1.732,00 €
				(2)	100119191	N710001005	2.632,00 €
				(1)	100119208	N710000916	1.873,00 €
		left gauche		(2)	100119224	N710000882	2.778,00 €
				(1)	100119171	N710000850	1.732,00 €
				(2)	100119192	N710000933	2.632,00 €
				(1)	100119209	N710000873	1.873,00 €
				(2)	100119225	N710000860	2.778,00 €



(1) Bath waste not included • Vidage non inclus

(2) Bath waste and overflow set included with filler • Vidage automatique avec bec verseur

## ACCESSORIES • ACCESSOIRES

	DESCRIPTION DESCRIPTION	COLOUR COULEUR	SAP	KEA	€	BASIC	FRAME CHASSIS	S0
	(1) Bath waste and overflow set NEXT + Syphon • Vidage automatique NEXT + Syphon		100060498	N780000002	51,00 €	✓	✓	✓
	(1) NEXT bath filler waste and overflow set including bath trap • Vidage NEXT avec bec verseur + Syphon		100060521	N780000008	130,00 €	✓	✓	✓
	COLD head rest • Appui-tête COLD		100066186	N770000052	91,00 €	✓	✓	✓
	Set of CASUAL universal support frame with feet CASUAL • Kit chassie universel CASUAL		100057508	N770000042	39,00 €	✓		
	(2) Bath access panel • Trappe de visite baignoire		250021559	N790001316	331,00 €	✓	✓	✓
	Set of chrome grab handles • Kit manettes chromées		250017240	N790001283	98,00 €	✓		
	ECOLITE panel 170 • Tablier 170 ECOLITE		100108340	N770000072	239,00 €		✓	✓
	ECOLITE panel 75 • Tablier 75 ECOLITE		100119002	N770000075	209,00 €		✓	✓

(1) Only required for the models not including brassware • Nécessaire uniquement pour les modèles sans robinetterie

(2) Required for all built-in installations • Nécessaire pour tous les modèles encastrés



## ECOLITE 180x80 cm.

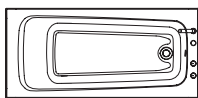

left  
gauche

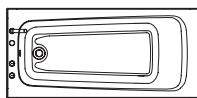

right  
droite

Water volume 196 l.  
Volume d'eau 196 l.

		POSITION POSITION	HANDLES MANETTES	BRASSWARE ROBINETTERIE	SAP	KEA	€
<b>BASIC</b>				(1)	100108332	N710000746	441,00 €
				(2)	100119085	N710000810	1.361,00 €
<b>BATH WITH FRAME CHASSIS SANS HYDROMAS- SAGE</b>				(1)	100119094	N710001003	866,00 €
				(2)	100119103	N710000818	1.759,00 €
				(1)	100119112	N710000900	999,00 €
				(2)	100119121	N710000928	1.903,00 €
<b>S0</b>		right droite		(1)	100119172	N710000899	1.812,00 €
				(2)	100119193	N710000866	2.672,00 €
				(1)	100119210	N710000913	1.956,00 €
		left gauche		(2)	100119226	N710000968	2.819,00 €
				(1)	100119173	N710000819	1.812,00 €
				(2)	100119194	N710000830	2.672,00 €
				(1)	100119211	N710000969	1.956,00 €
				(2)	100119227	N710000951	2.819,00 €



(1) Bath waste not included • Vidage non inclus  
(2) Bath waste and overflow set included with filler • Vidage automatique avec bec verseur

## ACCESSORIES • ACCESSOIRES

	DESCRIPTION DESCRIPTION	COLOUR COULEUR	SAP	KEA	€	BASIC	FRAME CHASSIS	S0
	(1) Bath waste and overflow set NEXT + Syphon • Vidage automatique NEXT + Syphon		100060498	N780000002	51,00 €	✓	✓	✓
	(1) NEXT bath filler waste and overflow set including bath trap • Vidage NEXT avec bec verseur + Syphon		100060521	N780000008	130,00 €	✓	✓	✓
	COLD head rest • Appui-tête COLD		100066186	N770000052	91,00 €	✓	✓	✓
	Set of CASUAL universal support frame with feet CASUAL • Kit chassiss universel CASUAL		100057508	N770000042	39,00 €	✓		
	(2) Bath access panel • Trappe de visite baignoire		250021559	N790001316	331,00 €	✓	✓	✓
	Set of chrome grab handles • Kit manettes chromées		250017240	N790001283	98,00 €	✓		
	ECOLITE panel 180 • Tablier 180 ECOLITE		100108341	N770000073	248,00 €		✓	✓
	ECOLITE panel 80 • Tablier 80 ECOLITE		100108343	N770000078	214,00 €		✓	✓

(1) Only required for the models not including brassware • Nécessaire uniquement pour les modèles sans robinetterie

(2) Required for all built-in installations • Nécessaire pour tous les modèles encastrés

## ECOLITE 140x140 cm.

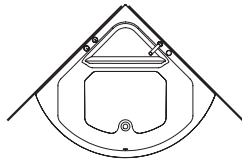

Water volume 306 l.  
Volume d'eau 306 l.

		HANDLES MANETTES	PANEL TABLIER	BRASSWARE ROBINETTERIE	SAP	KEA	€
<b>BASIC</b>				(1)	100118921	N710000804	627,00 €
				(2)	100119086	N710000993	1.569,00 €
<b>BATH WITH FRAME CHASSIS SANS HY- DROMAS- SAGE</b>				(1)	100119095	N710000778	1.001,00 €
				(2)	100119104	N710000797	1.903,00 €
				(1)	100119096	N710000723	1.439,00 €
				(2)	100119105	N710001014	2.250,00 €
				(1)	100119113	N710000992	1.109,00 €
				(2)	100119122	N710000963	2.031,00 €
				(1)	100119114	N710000816	1.569,00 €
				(2)	100119123	N710000857	2.383,00 €
<b>S0</b>				(1)	100119176	N710000869	1.863,00 €
				(2)	100119195	N710000733	2.776,00 €
				(1)	100119177	N710000738	2.222,00 €
				(2)	100119196	N710000937	3.153,00 €
				(1)	100119212	N710000868	1.991,00 €
				(2)	100119228	N710000884	2.914,00 €
				(1)	100119213	N710001025	2.359,00 €
				(2)	100119229	N710000962	3.296,00 €



<sup>(1)</sup> Bath waste not included • Vidage non inclus

<sup>(2)</sup> Bath waste and overflow set included with filler • Vidage automatique avec bec verseur

### ACCESSORIES • ACCESSOIRES

	DESCRIPTION DESCRIPTION	COLOUR COULEUR	SAP	KEA	€	BASIC	FRAME CHASSIS	S0
	<sup>(1)</sup> Bath waste and overflow set NEXT + Syphon • Vidage automatique NEXT + Syphon		100060498	N780000002	51,00 €	✓	✓	✓
	<sup>(1)</sup> NEXT bath filler waste and overflow set including bath trap • Vidage NEXT avec bec verseur + Syphon		100060521	N780000008	130,00 €	✓	✓	✓
	COLD head rest • Appui-tête COLD		100066186	N770000052	91,00 €	✓	✓	✓
	<sup>(2)</sup> Set of universal support frame with feet • Châssis universel avec pieds		100096848	N710000628	75,00 €	✓		
	<sup>(3)</sup> Bath access panel • Trappe de visite baignoire		250021559	N790001316	331,00 €	✓	✓	✓
	Set of chrome grab handles • Kit manettes chromées		250017240	N790001283	98,00 €	✓		
	ECOLITE panel 140 CORNER • Tablier 140 CORNER ECOLITE		100119001	N770000080	387,00 €		✓	✓

<sup>(1)</sup> Only required for the models not including brassware • Nécessaire uniquement pour les modèles sans robinetterie

<sup>(2)</sup> Recommended use of 2 sets • On recommande 2 jeux pour ce modèle

<sup>(3)</sup> Required for all built-in installations • Nécessaire pour tous les modèles encastrés



bathtubs / baignoires ACORE

## COLOURS • COULEURS

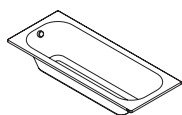

white  
blanc



Chrome  
Chromé

## ACCESSORIES • ACCESSOIRES



bath waste and overflow set  
*vidage automatique*



waste with chain  
*vidage avec chaîne*



support frame with feet  
*support pieds acier*



PVC support frame with feet  
*support pieds PVC*

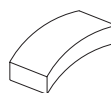

MILD head rest  
*appui tête MILD*

## SIZES cm. • FORMATS cm.

120x70 - 140x70 - 150x70 - 160x70 - 170x70 • 40h

## DRAWINGS mm. • PLANS mm.

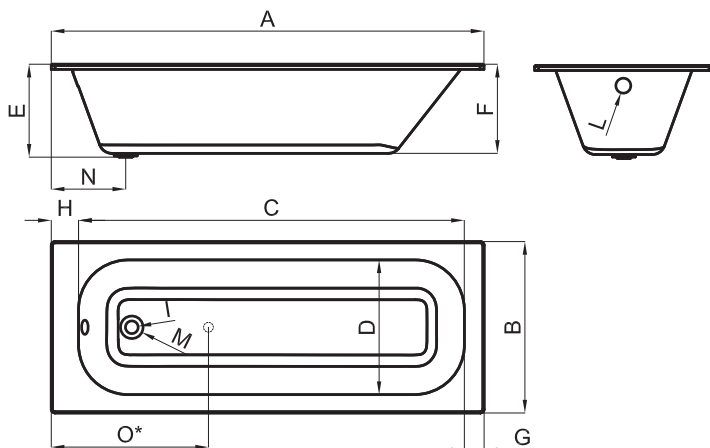

(\*) Waste - Vidage

mm	A	B	C	D	E	F	G	H	I	L	M	N	O
1200 x 700	1200	700	1050	550	400	380	50	100	52	52	88	300	450
1400 x 700	1400	700	1250	550	400	380	50	100	52	52	88	300	450
1500 x 700	1500	700	1350	550	400	380	50	100	52	52	88	300	450
1600 x 700	1600	700	1450	550	400	380	50	100	52	52	88	300	450
1700 x 700	1700	700	1550	550	400	380	50	100	52	52	88	300	450

## PACKAGING DETAILS • DONNÉES D'EXPÉDITION

	DIMENSIONS DIMENSIONS		VOLUME VOLUME	NET WEIGHT / PIECE POIDS NET / PIÈCE	GROSS WEIGHT / PALLET POIDS BRUT / PALETTE	PIECES / PALLET PIÈCES / PALETTE
120 x 70	L W H	120 cm 80 cm 135 cm	1,30 m <sup>3</sup>	16 Kg	380,16 Kg	22
140 x 70	L W H	120 cm 80 cm 155 cm	1,49 m <sup>3</sup>	19,2 Kg	449,24 Kg	22
150 x 70	L W H	120 cm 80 cm 165 cm	1,58 m <sup>3</sup>	20,8 Kg	485,54 Kg	22
160 x 70	L W H	120 cm 80 cm 175 cm	1,68 m <sup>3</sup>	21,5 Kg	501,6 Kg	22
170 x 70	L W H	120 cm 80 cm 185 cm	1,78 m <sup>3</sup>	23,5 Kg	544,72 Kg	22

ACORE 120x70 cm. - 140x70 cm. - 150x70 cm. - 160x70 cm. - 170x70 cm.

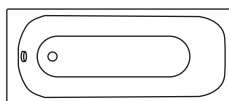

Enamelled steel bath • Baignoire en acier émaillé  
Bath waste not included • Vidage non inclus

		DIMENSIONS DIMENSIONS	Water volume VOLUME D'EAU	BRASSWARE ROBINETTERIE	SAP	KEA	€
<b>BASIC</b>		120 x 70	102	-	100050752	N710000036	220,00 €
		140 x 70	126	-	100050754	N710000046	220,00 €
		150 x 70	150	-	100050756	N710000097	220,00 €
		160 x 70	163	-	100050758	N710000054	220,00 €
		170 x 70	177	-	100050760	N710000050	220,00 €

## ACCESSORIES • ACCESSOIRES

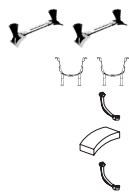

DESCRIPTION DESCRIPTION	SAP	KEA	€	BASIC
ACORE PVC support frame with feet • Support pieds ACORE PVC	100056385	N770000055	30,00 €	✓
ACORE support frame with feet • Support pieds ACORE acier	100056386	N770000008	49,00 €	✓
Waste with chain • Vidage avec chaîne	250020229	N790001409	18,00 €	✓
MILD head rest • Appui tête MILD	100066187	N770000050	91,00 €	✓
Bath waste and overflow set NEXT chrome • Vidage automatique NEXT chromé	100060498	N780000002	51,00 €	✓

[www.noken.com](http://www.noken.com)



NOKEN DESIGN, S.A.

Ctra. Villarreal - Puebla de arenoso km. 2 (CV-20) - 12540 Vila-real · Castellón · Spain

Tel: +34 964 506 450 - Fax (Nac.): +34 964 506 789 - Fax (Export): +34 964 506 791 - e-mail: [noken@noken.com](mailto:noken@noken.com) - [export@noken.com](mailto:export@noken.com)

Edition data / Date d'édition: January 2015 / Janvier 2015

Design / Dessin: Noken Marketing Department / Département Marketing Noken

Photography / Photographie: Noken Marketing Department / Département Marketing Noken

Printed by / Imprime: ALTERNATIVA GRAFICA

Edition / Édite: NOKEN DESIGN S.A.

NOKEN DESIGN, S.A.

The contents of this catalogue are protected by virtue of the Spanish Intellectual Property Act, Royal Legislative Decree 1/1996. The partial or total reproduction of this catalogue, without the express authorisation of NOKEN DESIGN is punishable under the Spanish Criminal Code.

Le contenu de ce catalogue est protégé par la Loi des Propriétés intellectuelles. Toute reproduction, même partielle, sans autorisation de Noken Design, S.A. sera sanctionnée par le Code Pénal.

NOKEN DESIGN, S.A.

Reserves the right to cancel and/or change models or accessories without prior notice or replacement. The settings shown in this catalogue are design proposals for advertising purposes. In real situations in which the tiles are laid, we recommend to use as a guide for the installation, the technical specifications available on the Noken Price List.

Se réserve le droit d'annuler, de modifier ou supprimer les produits et accessoires présentés sans préavis ni obligation de les remplacer. Les ambiances présentées dans ce catalogue sont des suggestions de décoration à titre publicitaire. Pour toute installation, il faudra consulter les fiches techniques qui se trouvent dans le Tarif Général édité par Noken.



# 2015

**baths**  
**baignoires**

**noken**  
PORCELANOSA Grupo

NOKEN DESIGN, S.A.

Ctra. Villarreal - Puebla de arenoso km. 2 (CV-20) - 12540 Vila-real - Castellón - Spain - Tel: +34 964 506 450 - Fax (Nac.): +34 964 506 789 - Fax (Export): +34 964 506 791 - e-mail: [noken@noken.com](mailto:noken@noken.com) - [export@noken.com](mailto:export@noken.com)