

# ECOLITE

bathtubs - baignoires



bathtubs / baignoires ECOLITE

## COLOURS • COULEURS



## ACCESSORIES • ACCESSOIRES

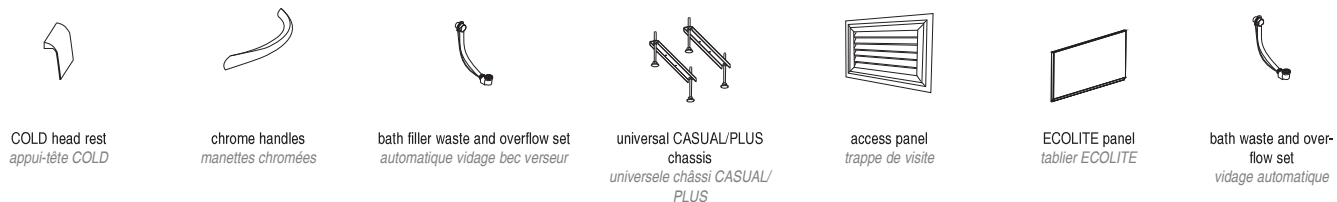

## SIZES cm. • FORMATS cm.

140x70 • 150x70 • 160x70 • 160x75 • 170x70 • 170x75 • 180x80 • 53h  
140x140 • 56,5h

## EQUIPMENT • EQUIPEMENT

	
	S0
JETS	6

See features on page 22-25.  
Consultez caractéristiques en page 22-25.

## DRAWINGS mm. • PLANS mm.

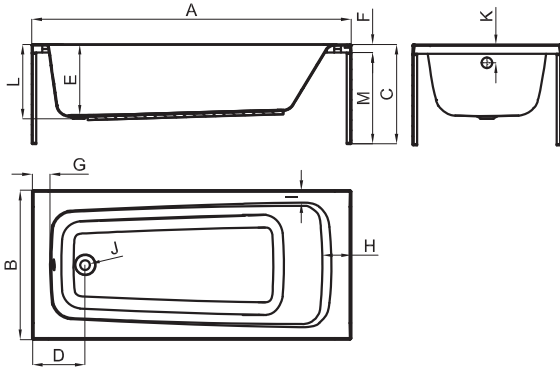

mm	A	B	C	D	E	F	G	H	I	J	K	L	M	N
1400x700	1400	700	530	250	380	45	90	120	70	Ø52	90	400	485	130
1500x700	1500	700	530	250	380	45	90	120	70	Ø52	90	400	485	130
1600x700	1600	700	530	250	380	45	90	120	70	Ø52	90	400	485	130
1600x750	1600	750	530	250	380	45	90	120	70	Ø52	90	400	485	130
1700x700	1700	700	530	250	380	45	90	120	70	Ø52	90	400	485	130
1700x750	1700	750	530	250	380	45	90	120	70	Ø52	90	400	485	130
1800x800	1800	800	530	250	380	45	90	120	70	Ø52	90	400	485	130

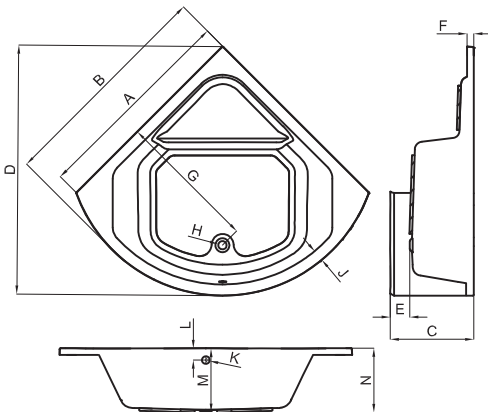



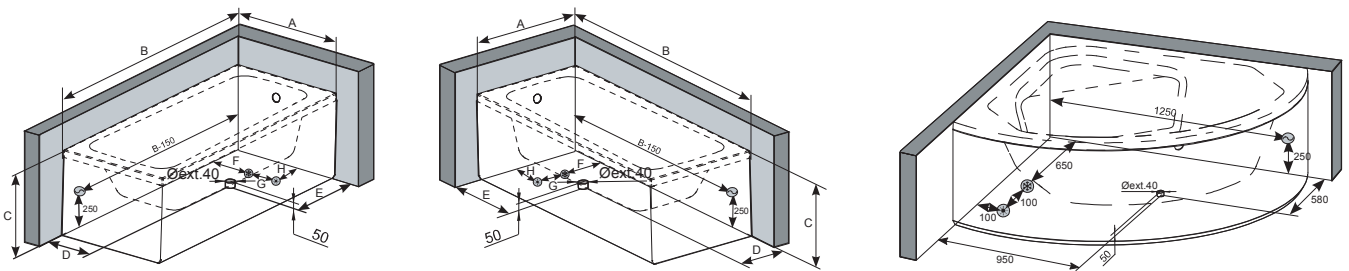

mm	A	B	C	D	E	F	G	H	I	J	K	L	M	N
1400x1400	1400	1500	565	1690	130	45	950	Ø52	1980	80	52	80	415	435

## PRE-INSTALLING • PRE-INSTALLATION



Left Gauche  
Right Droite

mm	A	B	C	D	E	F	G	H
1400x700	700	1400	535	350	600	500	100	100
1500x700	700	1500	535	350	600	500	100	100
1600x700	700	1600	535	350	600	500	100	100
1600x750	750	1600	535	375	600	500	100	100
1700x700	700	1700	535	350	600	500	100	100
1700x750	750	1700	535	375	600	500	100	100
1800x800	800	1800	535	400	600	500	100	100

	Hot water connections Prise d'eau chaude
	Cold water connections Prise d'eau froide
	Waste Vidage
	Electrical connections Câblage électrique

## PACKAGING DETAILS • DONNÉES D'EXPÉDITION

		DIMENSIONS DIMENSIONS		VOLUME VOLUME	NET WEIGHT / PIECE POIDS NET / PIÈCE	GROSS WEIGHT / PALLET POIDS BRUT / PALETTE	PIECES / PALLET PIÈCES / PALETTE
140x70	BASIC	L W H	120 cm 80 cm 160 cm	1,54 m <sup>3</sup>	19 Kg	248 Kg	12
	BATH WITH FRAME CHASSIS SANS HYDROMAS- SAGE	L W H	144 cm 74 cm 69 cm	0,74 m <sup>3</sup>	23,8 Kg	32,8 Kg	1
	S0	L W H	144 cm 74 cm 69 cm	0,74 m <sup>3</sup>	32,4 Kg	41,4 Kg	1
150x70	BASIC	L W H	120 cm 80 cm 170 cm	1,63 m <sup>3</sup>	21,5 Kg	278 Kg	12
	BATH WITH FRAME CHASSIS SANS HYDROMAS- SAGE	L W H	154 cm 74 cm 69 cm	0,79 m <sup>3</sup>	26,5 Kg	36 Kg	1
	S0	L W H	154 cm 74 cm 69 cm	0,79 m <sup>3</sup>	35,2 Kg	44,7 Kg	1
160x70	BASIC	L W H	120 cm 80 cm 180 cm	1,73 m <sup>3</sup>	23 Kg	296 Kg	12
	BATH WITH FRAME CHASSIS SANS HYDROMAS- SAGE	L W H	164 cm 79 cm 69 cm	0,89 m <sup>3</sup>	28,3 Kg	38,3 Kg	1
	S0	L W H	164 cm 79 cm 69 cm	0,89 m <sup>3</sup>	36,9 Kg	46,9 Kg	1
160x75	BASIC	L W H	120 cm 80 cm 180 cm	1,73 m <sup>3</sup>	24 Kg	308 Kg	12
	BATH WITH FRAME CHASSIS SANS HYDROMAS- SAGE	L W H	164 cm 79 cm 69 cm	0,89 m <sup>3</sup>	29,4 Kg	39,4 Kg	1
	S0	L W H	164 cm 79 cm 69 cm	0,89 m <sup>3</sup>	38 Kg	48 Kg	1
170x70	BASIC	L W H	120 cm 80 cm 190 cm	1,82 m <sup>3</sup>	26 Kg	384 Kg	14
	BATH WITH FRAME CHASSIS SANS HYDROMAS- SAGE	L W H	174 cm 79 cm 69 cm	0,95 m <sup>3</sup>	30 Kg	40,5 Kg	1
	S0	L W H	174 cm 79 cm 69 cm	0,95 m <sup>3</sup>	38,6 Kg	49,1 Kg	1
170x75	BASIC	L W H	120 cm 80 cm 190 cm	2,05 m <sup>3</sup>	27 Kg	344 Kg	12
	BATH WITH FRAME CHASSIS SANS HYDROMAS- SAGE	L W H	174 cm 79 cm 69 cm	0,95 m <sup>3</sup>	31,1 Kg	41,6 Kg	1
	S0	L W H	174 cm 79 cm 69 cm	0,95 m <sup>3</sup>	39,7 Kg	50,2 Kg	1
180x80	BASIC	L W H	120 cm 90 cm 200 cm	2,16 m <sup>3</sup>	29 Kg	368 Kg	12
	BATH WITH FRAME CHASSIS SANS HYDROMAS- SAGE	L W H	185 cm 85 cm 69 cm	1,08 m <sup>3</sup>	35 Kg	39 Kg	1
	S0	L W H	185 cm 85 cm 69 cm	1,08 m <sup>3</sup>	40 Kg	49 Kg	1
140x140	BASIC	L W H	152 cm 120 cm 160 cm	2,92 m <sup>3</sup>	32 Kg	404 Kg	12
	BATH WITH FRAME CHASSIS SANS HYDROMAS- SAGE	L W H	155 cm 155 cm 69 cm	1,65 m <sup>3</sup>	37 Kg	50 Kg	1
	S0	L W H	155 cm 155 cm 69 cm	1,65 m <sup>3</sup>	42 Kg	55 Kg	1

## ECOLITE 140x70 cm.

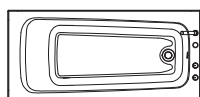

left  
gauche

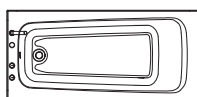

right  
droite

Water volume 116 l.  
Volume d'eau 116 l.

		POSITION POSITION	HANDLES MANETTES	BRASSWARE ROBINETTERIE	SAP	KEA	€
<b>BASIC</b>				(1)_	100118916	N710000805	370,00 €
				(2)	100119079	N710000934	1.262,00 €
<b>BATH WITH FRAME CHASSIS SANS HYDROMASSAGE</b>				(1)_	100119088	N710000984	704,00 €
				(2)	100119097	N710000889	1.617,00 €
				(1)_	100119106	N710000742	826,00 €
				(2)	100119115	N710001023	1.758,00 €
<b>S0</b>		right droite		(1)_	100119160	N710000905	1.709,00 €
				(2)	100119181	N710000843	2.567,00 €
				(1)_	100119198	N710000935	1.853,00 €
		left gauche		(2)	100119214	N710000946	2.714,00 €
				(1)_	100119161	N710000910	1.709,00 €
				(2)	100119182	N710000983	2.567,00 €
				(1)_	100119199	N710000871	1.853,00 €
				(2)	100119215	N710000852	2.714,00 €



(1) Bath waste not included • Vidage non inclus  
(2) Bath waste and overflow set included with filler • Vidage automatique avec bec verseur

## ACCESSORIES • ACCESSOIRES

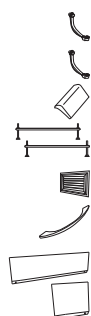

DESCRIPTION DESCRIPTION	COLOUR COULEUR	SAP	KEA	€	BASIC	FRAME CHASSIS	S0
(1) Bath waste and overflow set NEXT + Syphon • Vidage automatique NEXT + Syphon		100060498	N780000002	51,00 €	✓	✓	✓
(1) NEXT bath filler waste and overflow set including bath trap • Vidage NEXT avec bec verseur + Syphon		100060521	N780000008	130,00 €	✓	✓	✓
COLD head rest • Appui-tête COLD		100066186	N770000052	91,00 €	✓	✓	✓
Set of CASUAL universal support frame with feet CASUAL • Kit chassie universel CASUAL		100057508	N770000042	39,00 €	✓		
(2) Bath access panel • Trappe de visite baignoire		250021559	N790001316	331,00 €	✓	✓	✓
Set of chrome grab handles • Kit manettes chromées		250017240	N790001283	98,00 €	✓		
ECOLITE panel 140 • Tablier 140 ECOLITE		100118998	N770000081	218,00 €		✓	✓
ECOLITE panel 70 • Tablier 70 ECOLITE		100108342	N770000079	209,00 €		✓	✓

(1) Only required for the models not including brassware • Nécessaire uniquement pour les modèles sans robinetterie

(2) Required for all built-in installations • Nécessaire pour tous les modèles encastrés

## ECOLITE 150x70 cm.

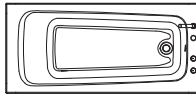

left  
gauche

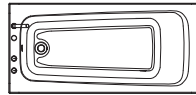

right  
droite

Water volume 128 l.  
Volume d'eau 128 l.

		POSITION POSITION	HANDLES MANETTES	BRASSWARE ROBINETTERIE	SAP	KEA	€
<b>BASIC</b>				(1)_	100118917	N710000863	370,00 €
				(2)	100119080	N710000919	1.269,00 €
<b>BATH WITH FRAME CHASSIS SANS HYDROMASSAGE</b>				(1)_	100119089	N710000800	705,00 €
				(2)	100119098	N710000782	1.622,00 €
				(1)_	100119107	N710000893	823,00 €
				(2)	100119116	N710000767	1.762,00 €
<b>S0</b>		right droite		(1)_	100119162	N710000877	1.712,00 €
				(2)	100119183	N710000879	2.585,00 €
				(1)_	100119200	N710000731	1.856,00 €
				(2)	100119216	N710000901	2.731,00 €
		left gauche		(1)_	100119163	N710000874	1.712,00 €
				(2)	100119184	N710000826	2.585,00 €
				(1)_	100119201	N710000829	1.856,00 €
				(2)	100119217	N710001016	2.731,00 €



(1) Bath waste not included • Vidage non inclus

(2) Bath waste and overflow set included with filler • Vidage automatique avec bec verseur

## ACCESSORIES • ACCESSOIRES

	DESCRIPTION DESCRIPTION	COLOUR COULEUR	SAP	KEA	€	BASIC	FRAME CHASSIS	S0
	(1) Bath waste and overflow set NEXT + Syphon • Vidage automatique NEXT + Syphon		100060498	N780000002	51,00 €	✓	✓	✓
	(1) NEXT bath filler waste and overflow set including bath trap • Vidage NEXT avec bec verseur + Syphon		100060521	N780000008	130,00 €	✓	✓	✓
	COLD head rest • Appui-tête COLD		100066186	N770000052	91,00 €	✓	✓	✓
	Set of CASUAL universal support frame with feet CASUAL • Kit chassiss universel CASUAL		100057508	N770000042	39,00 €	✓		
	(2) Bath access panel • Trappe de visite baignoire		250021559	N790001316	331,00 €	✓	✓	✓
	Set of chrome grab handles • Kit manettes chromées		250017240	N790001283	98,00 €	✓		
	ECOLITE panel 150 • Tablier 150 ECOLITE		100118999	N770000076	218,00 €		✓	✓
	ECOLITE panel 70 • Tablier 70 ECOLITE		100108342	N770000079	209,00 €		✓	✓

(1) Only required for the models not including brassware • Nécessaire uniquement pour les modèles sans robinetterie

(2) Required for all built-in installations • Nécessaire pour tous les modèles encastrés

## ECOLITE 160x70 cm.

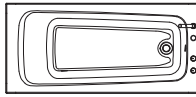

left  
gauche

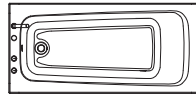

right  
droite

Water volume 139 l.  
Volume d'eau 139 l.

		POSITION POSITION	HANDLES MANETTES	BRASSWARE ROBINETTERIE	SAP	KEA	€
<b>BASIC</b>				(1)_	100118918	N710001026	372,00 €
				(2)	100119081	N710000861	1.279,00 €
<b>BATH WITH FRAME CHASSIS SANS HYDROMASSAGE</b>				(1)_	100119090	N710000953	707,00 €
				(2)	100119099	N710001002	1.624,00 €
				(1)_	100119108	N710000887	824,00 €
				(2)	100119117	N710000921	1.762,00 €
<b>S0</b>		right droite		(1)_	100119164	N710000922	1.719,00 €
				(2)	100119185	N710000981	2.604,00 €
				(1)_	100119202	N710000815	1.859,00 €
		left gauche		(2)	100119218	N710001021	2.752,00 €
				(1)_	100119165	N710000979	1.719,00 €
				(2)	100119186	N710000832	2.604,00 €
				(1)_	100119203	N710000888	1.859,00 €
				(2)	100119219	N710000838	2.752,00 €



(1) Bath waste not included • Vidage non inclus  
(2) Bath waste and overflow set included with filler • Vidage automatique avec bec verseur

## ACCESSORIES • ACCESSOIRES

	DESCRIPTION DESCRIPTION	COLOUR COULEUR	SAP	KEA	€	BASIC	FRAME CHASSIS	S0
	(1) Bath waste and overflow set NEXT + Syphon • Vidage automatique NEXT + Syphon		100060498	N780000002	51,00 €	✓	✓	✓
	(1) NEXT bath filler waste and overflow set including bath trap • Vidage NEXT avec bec verseur + Syphon		100060521	N780000008	130,00 €	✓	✓	✓
	COLD head rest • Appui-tête COLD		100066186	N770000052	91,00 €	✓	✓	✓
	Set of CASUAL universal support frame with feet CASUAL • Kit chassiss universel CASUAL		100057508	N770000042	39,00 €	✓		
	(2) Bath access panel • Trappe de visite baignoire		250021559	N790001316	331,00 €	✓	✓	✓
	Set of chrome grab handles • Kit manettes chromées		250017240	N790001283	98,00 €	✓		
ECOLITE panel 160 • Tablier 160 ECOLITE		100119000	N770000077	227,00 €		✓	✓	
ECOLITE panel 70 • Tablier 70 ECOLITE		100108342	N770000079	209,00 €		✓	✓	

(1) Only required for the models not including brassware • Nécessaire uniquement pour les modèles sans robinetterie

(2) Required for all built-in installations • Nécessaire pour tous les modèles encastrés



## ECOLITE 160x75 cm.

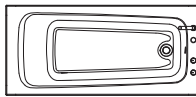

left  
gauche

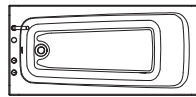

right  
droite

Water volume 154 l.  
Volume d'eau 154 l.

		POSITION POSITION	HANDLES MANETTES	BRASSWARE ROBINETTERIE	SAP	KEA	€
<b>BASIC</b>				(1)_	100118919	N710000918	373,00 €
				(2)	100119082	N710000881	1.288,00 €
<b>BATH WITH FRAME CHASSIS SANS HYDROMASSAGE</b>				(1)_	100119091	N710000781	709,00 €
				(2)	100119100	N710000718	1.630,00 €
				(1)_	100119109	N710001015	824,00 €
				(2)	100119118	N710000768	1.769,00 €
<b>S0</b>		right droite		(1)_	100119166	N710000833	1.724,00 €
				(2)	100119187	N710000828	2.615,00 €
				(1)_	100119204	N710000936	1.870,00 €
		left gauche		(2)	100119220	N710000926	2.762,00 €
				(1)_	100119167	N710000727	1.724,00 €
				(2)	100119188	N710000897	2.615,00 €
				(1)_	100119205	N710000891	1.870,00 €
				(2)	100119221	N710000878	2.762,00 €



(1) Bath waste not included • Vidage non inclus

(2) Bath waste and overflow set included with filler • Vidage automatique avec bec verseur

## ACCESSORIES • ACCESSOIRES

	DESCRIPTION DESCRIPTION	COLOUR COULEUR	SAP	KEA	€	BASIC	FRAME CHASSIS	S0
	(1) Bath waste and overflow set NEXT + Syphon • Vidage automatique NEXT + Syphon		100060498	N780000002	51,00 €	✓	✓	✓
	(1) NEXT bath filler waste and overflow set including bath trap • Vidage NEXT avec bec verseur + Syphon		100060521	N780000008	130,00 €	✓	✓	✓
	COLD head rest • Appui-tête COLD		100066186	N770000052	91,00 €	✓	✓	✓
	Set of CASUAL universal support frame with feet CASUAL • Kit chassiss universel CASUAL		100057508	N770000042	39,00 €	✓		
	(2) Bath access panel • Trappe de visite baignoire		250021559	N790001316	331,00 €	✓	✓	✓
	Set of chrome grab handles • Kit manettes chromées		250017240	N790001283	98,00 €	✓		
	ECOLITE panel 160 • Tablier 160 ECOLITE		100119000	N770000077	227,00 €		✓	✓
	ECOLITE panel 75 • Tablier 75 ECOLITE		100119002	N770000075	209,00 €		✓	✓

(1) Only required for the models not including brassware • Nécessaire uniquement pour les modèles sans robinetterie

(2) Required for all built-in installations • Nécessaire pour tous les modèles encastrés

## ECOLITE 170x70 cm.

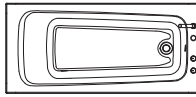

left  
gauche

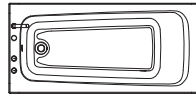

right  
droite

Water volume 150 l.  
Volume d'eau 150 l.

		POSITION POSITION	HANDLES MANETTES	BRASSWARE ROBINETTERIE	SAP	KEA	€
<b>BASIC</b>				(1)_	100108331	N710000717	375,00 €
				(2)	100119083	N710000894	1.290,00 €
<b>BATH WITH FRAME CHASSIS SANS HYDROMASSAGE</b>				(1)_	100119092	N710000849	710,00 €
				(2)	100119101	N710000902	1.632,00 €
				(1)_	100119110	N710000914	826,00 €
				(2)	100119119	N710000812	1.770,00 €
<b>S0</b>		right droite		(1)_	100119168	N710000836	1.728,00 €
				(2)	100119189	N710000974	2.617,00 €
				(1)_	100119206	N710000870	1.872,00 €
		left gauche		(2)	100119222	N710000927	2.763,00 €
				(1)_	100119169	N710000854	1.728,00 €
				(2)	100119190	N710000840	2.617,00 €
				(1)_	100119207	N710000930	1.872,00 €
				(2)	100119223	N710000848	2.763,00 €



(1) Bath waste not included • Vidage non inclus

(2) Bath waste and overflow set included with filler • Vidage automatique avec bec verseur

## ACCESSORIES • ACCESSOIRES

	DESCRIPTION DESCRIPTION	COLOUR COULEUR	SAP	KEA	€	BASIC	FRAME CHASSIS	S0
	(1) Bath waste and overflow set NEXT + Syphon • Vidage automatique NEXT + Syphon		100060498	N780000002	51,00 €	✓	✓	✓
	(1) NEXT bath filler waste and overflow set including bath trap • Vidage NEXT avec bec verseur + Syphon		100060521	N780000008	130,00 €	✓	✓	✓
	COLD head rest • Appui-tête COLD		100066186	N770000052	91,00 €	✓	✓	✓
	Set of CASUAL universal support frame with feet CASUAL • Kit chassiss universel CASUAL		100057508	N770000042	39,00 €	✓		
	(2) Bath access panel • Trappe de visite baignoire		250021559	N790001316	331,00 €	✓	✓	✓
	Set of chrome grab handles • Kit manettes chromées		250017240	N790001283	98,00 €	✓		
ECOLITE panel 170 • Tablier 170 ECOLITE		100108340	N770000072	239,00 €		✓	✓	
ECOLITE panel 70 • Tablier 70 ECOLITE		100108342	N770000079	209,00 €		✓	✓	

(1) Only required for the models not including brassware • Nécessaire uniquement pour les modèles sans robinetterie

(2) Required for all built-in installations • Nécessaire pour tous les modèles encastrés



## ECOLITE 170x75 cm.

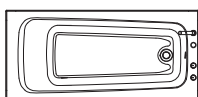

left  
gauche

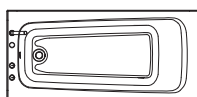

right  
droite

Water volume 166 l.  
Volume d'eau 166 l.

		POSITION POSITION	HANDLES MANETTES	BRASSWARE ROBINETTERIE	SAP	KEA	€
<b>BASIC</b>				(1)_	100118920	N710000712	383,00 €
				(2)	100119084	N710000806	1.294,00 €
<b>BATH WITH FRAME CHASSIS SANS HYDROMASSAGE</b>				(1)_	100119093	N710000908	719,00 €
				(2)	100119102	N710000739	1.639,00 €
				(1)_	100119111	N710001054	835,00 €
				(2)	100119120	N710000880	1.776,00 €
<b>S0</b>		right droite		(1)_	100119170	N710000890	1.732,00 €
				(2)	100119191	N710001005	2.632,00 €
				(1)_	100119208	N710000916	1.873,00 €
				(2)	100119224	N710000882	2.778,00 €
		left gauche		(1)_	100119171	N710000850	1.732,00 €
				(2)	100119192	N710000933	2.632,00 €
				(1)_	100119209	N710000873	1.873,00 €
				(2)	100119225	N710000860	2.778,00 €



(1) Bath waste not included • Vidage non inclus

(2) Bath waste and overflow set included with filler • Vidage automatique avec bec verseur

## ACCESSORIES • ACCESSOIRES

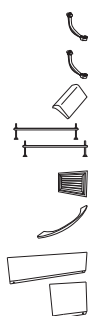

DESCRIPTION DESCRIPTION	COLOUR COULEUR	SAP	KEA	€	BASIC	FRAME CHASSIS	S0
(1) Bath waste and overflow set NEXT + Syphon • Vidage automatique NEXT + Syphon		100060498	N780000002	51,00 €	✓	✓	✓
(1) NEXT bath filler waste and overflow set including bath trap • Vidage NEXT avec bec verseur + Syphon		100060521	N780000008	130,00 €	✓	✓	✓
COLD head rest • Appui-tête COLD		100066186	N770000052	91,00 €	✓	✓	✓
Set of CASUAL universal support frame with feet CASUAL • Kit chassiss universel CASUAL		100057508	N770000042	39,00 €	✓		
(2) Bath access panel • Trappe de visite baignoire		250021559	N790001316	331,00 €	✓	✓	✓
Set of chrome grab handles • Kit manettes chromées		250017240	N790001283	98,00 €	✓		
ECOLITE panel 170 • Tablier 170 ECOLITE		100108340	N770000072	239,00 €		✓	✓
ECOLITE panel 75 • Tablier 75 ECOLITE		100119002	N770000075	209,00 €		✓	✓

(1) Only required for the models not including brassware • Nécessaire uniquement pour les modèles sans robinetterie

(2) Required for all built-in installations • Nécessaire pour tous les modèles encastrés

## ECOLITE 180x80 cm.

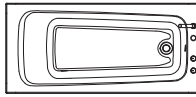

left  
gauche

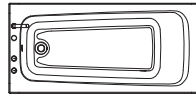

right  
droite

Water volume 196 l.  
Volume d'eau 196 l.

		POSITION POSITION	HANDLES MANETTES	BRASSWARE ROBINETTERIE	SAP	KEA	€
<b>BASIC</b>				(1)_	100108332	N710000746	441,00 €
				(2)	100119085	N710000810	1.361,00 €
<b>BATH WITH FRAME CHASSIS SANS HYDROMASSAGE</b>				(1)_	100119094	N710001003	866,00 €
				(2)	100119103	N710000818	1.759,00 €
				(1)_	100119112	N710000900	999,00 €
				(2)	100119121	N710000928	1.903,00 €
<b>S0</b>		right droite		(1)_	100119172	N710000899	1.812,00 €
				(2)	100119193	N710000866	2.672,00 €
				(1)_	100119210	N710000913	1.956,00 €
		left gauche		(2)	100119226	N710000968	2.819,00 €
				(1)_	100119173	N710000819	1.812,00 €
				(2)	100119194	N710000830	2.672,00 €
				(1)_	100119211	N710000969	1.956,00 €
				(2)	100119227	N710000951	2.819,00 €



(1) Bath waste not included • Vidage non inclus  
(2) Bath waste and overflow set included with filler • Vidage automatique avec bec verseur

## ACCESSORIES • ACCESSOIRES

	DESCRIPTION DESCRIPTION	COLOUR COULEUR	SAP	KEA	€	BASIC	FRAME CHASSIS	S0
	(1) Bath waste and overflow set NEXT + Syphon • Vidage automatique NEXT + Syphon		100060498	N780000002	51,00 €	✓	✓	✓
	(1) NEXT bath filler waste and overflow set including bath trap • Vidage NEXT avec bec verseur + Syphon		100060521	N780000008	130,00 €	✓	✓	✓
	COLD head rest • Appui-tête COLD		100066186	N770000052	91,00 €	✓	✓	✓
	Set of CASUAL universal support frame with feet CASUAL • Kit chassiss universel CASUAL		100057508	N770000042	39,00 €	✓		
	(2) Bath access panel • Trappe de visite baignoire		250021559	N790001316	331,00 €	✓	✓	✓
	Set of chrome grab handles • Kit manettes chromées		250017240	N790001283	98,00 €	✓		
	ECOLITE panel 180 • Tablier 180 ECOLITE		100108341	N770000073	248,00 €		✓	✓
	ECOLITE panel 80 • Tablier 80 ECOLITE		100108343	N770000078	214,00 €		✓	✓

(1) Only required for the models not including brassware • Nécessaire uniquement pour les modèles sans robinetterie

(2) Required for all built-in installations • Nécessaire pour tous les modèles encastrés

## ECOLITE 140x140 cm.

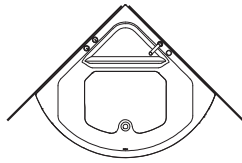

Water volume 306 l.  
Volume d'eau 306 l.

		HANDLES MANETTES	PANEL TABLIER	BRASSWARE ROBINETTERIE	SAP	KEA	€
<b>BASIC</b>				(1) _	100118921	N710000804	627,00 €
				(2)	100119086	N710000993	1.569,00 €
<b>BATH WITH FRAME CHASSIS SANS HY- DROMAS- SAGE</b>				(1) _	100119095	N710000778	1.001,00 €
				(2)	100119104	N710000797	1.903,00 €
				(1) _	100119096	N710000723	1.439,00 €
				(2)	100119105	N710001014	2.250,00 €
				(1) _	100119113	N710000992	1.109,00 €
				(2)	100119122	N710000963	2.031,00 €
				(1) _	100119114	N710000816	1.569,00 €
				(2)	100119123	N710000857	2.383,00 €
<b>S0</b>				(1) _	100119176	N710000869	1.863,00 €
				(2)	100119195	N710000733	2.776,00 €
				(1) _	100119177	N710000738	2.222,00 €
				(2)	100119196	N710000937	3.153,00 €
				(1) _	100119212	N710000868	1.991,00 €
				(2)	100119228	N710000884	2.914,00 €
				(1) _	100119213	N710001025	2.359,00 €
				(2)	100119229	N710000962	3.296,00 €



(1) Bath waste not included • Vidage non inclus  
(2) Bath waste and overflow set included with filler • Vidage automatique avec bec verseur

### ACCESSORIES • ACCESSOIRES

	DESCRIPTION DESCRIPTION	COLOUR COULEUR	SAP	KEA	€	BASIC	FRAME CHASSIS	S0
	(1) Bath waste and overflow set NEXT + Syphon • Vidage automatique NEXT + Syphon		100060498	N780000002	51,00 €	✓	✓	✓
	(1) NEXT bath filler waste and overflow set including bath trap • Vidage NEXT avec bec verseur + Syphon		100060521	N780000008	130,00 €	✓	✓	✓
	COLD head rest • Appui-tête COLD		100066186	N770000052	91,00 €	✓	✓	✓
	(2) Set of universal support frame with feet • Châssis universel avec pieds		100096848	N710000628	75,00 €	✓		
	(3) Bath access panel • Trappe de visite baignoire		250021559	N790001316	331,00 €	✓	✓	✓
	Set of chrome grab handles • Kit manettes chromées		250017240	N790001283	98,00 €	✓		
	ECOLITE panel 140 CORNER • Tablier 140 CORNER ECOLITE		100119001	N770000080	387,00 €		✓	✓

(1) Only required for the models not including brassware • Nécessaire uniquement pour les modèles sans robinetterie

(2) Recommended use of 2 sets • On recommande 2 jeux pour ce modèle

(3) Required for all built-in installations • Nécessaire pour tous les modèles encastrés