

SOLEIL SINGLE

bathtubs - baignoires



bathtubs / baignoires SOLEIL SINGLE

COLOURS • COULEURS



CLUB panel
tablier CLUB



white
blanc



black
noir



Inox



MODUL panel
tablier MODUL



white
blanc



chrome / white
chromé / blanc



Chrome
Chromé

ACCESSORIES • ACCESSOIRES



ENJOY head rest
Appui-tête ENJOY



ENJOY "S" head rest
Appui-tête ENJOY "S"



COLD head rest
appui-tête COLD



Set of universal support
frame with feet CASUAL
châssis universel
CASUAL



CLUB panel
tablier CLUB



MODUL panel
tablier MODUL



access panel
trappe de visite



bath waste and
overflow set
vidage automatique



bath filler waste and over-
flow set
automatique vidage bec
verseur



deck mounted valves and
handset
robinetterie

SOLEIL SINGLE

bathtubs - baignoires

SIZES cm. • FORMATS cm.

160x70 • 62,5h
170x75 • 62,5h
180x80 • 62,5h

EQUIPMENT • EQUIPEMENT

		S0	SX1	SX2	SX3	SX4	SX5
JETS		6	-	8	8	8	-
BLOWERS		-	8	-	8	8	8
CHROMOTHERAPY CHROMOTHERAPIE		-	-	-	-	8	8
DISINFECTION DÉSINFECTION		-	-	-	-	✓	-

See features on page 22-25.

Consultez caractéristiques en page 22-25.

DRAWINGS mm. • PLANS mm.

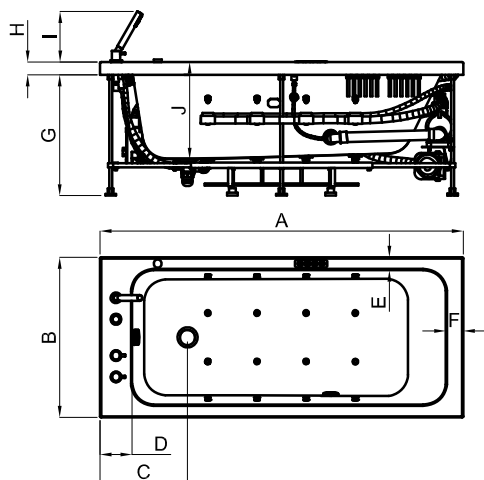

mm	A	B	C	D	E	F	G	H	I	J
1600 x 700	1600	700	415	150	60	80	565	60	250	450
1700 x 750	1700	750								
1800 x 800	1800	800								

PRE-INSTALLING • PRE-INSTALLATION

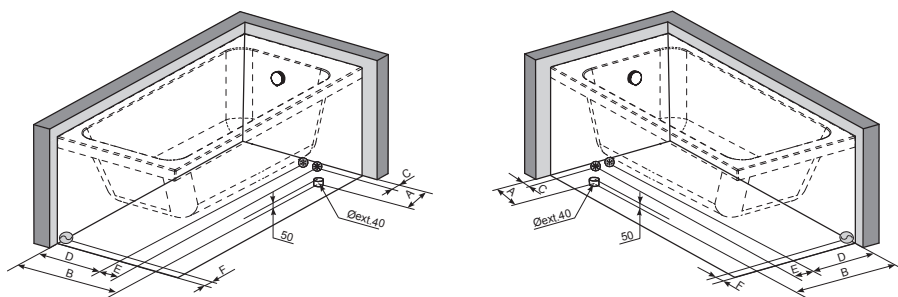

Left
Gauche

Right
Droite

	Hot water connections Prise d'eau chaude
	Cold water connections Prise d'eau froide
	Waste Vidage
	Electrical connections Câblage électrique

mm	A	B	C	D	E	F
1600 x 700	220	600	50	400	100	50
1700 x 750						
1800 x 800						

PACKAGING DETAILS • DONNÉES D'EXPÉDITION

		DIMENSIONS DIMENSIONS		VOLUME VOLUME	NET WEIGHT / PIECE POIDS NET / PIÈCE	GROSS WEIGHT / PALLET POIDS BRUT / PALETTE	PIECES / PALLET PIÈCES / PALETTE
160x70	BASIC	L W H	130 cm 72 cm 140 cm	1,31 m ³	20 Kg	220 Kg	10
	BATH WITH FRAME CHASSIS SANS HYDROMAS- SAGE	L W H	163 cm 73 cm 81 cm	0,96 m ³	33 Kg	45 Kg	1
	S0	L W H	163 cm 73 cm 81 cm	0,96 m ³	48 Kg	60 Kg	1
	SX1	L W H	163 cm 73 cm 81 cm	0,96 m ³	49 Kg	61 Kg	1
	SX2	L W H	163 cm 73 cm 81 cm	0,96 m ³	49 Kg	61 Kg	1
	SX3	L W H	163 cm 73 cm 81 cm	0,96 m ³	56 Kg	68 Kg	1
	SX4	L W H	163 cm 73 cm 81 cm	0,96 m ³	61 Kg	73 Kg	1
	SX5	L W H	163 cm 73 cm 81 cm	0,96 m ³	49 Kg	61 Kg	1
170x75	BASIC	L W H	130 cm 77 cm 140 cm	1,4 m ³	24 Kg	260 Kg	10
	BATH WITH FRAME CHASSIS SANS HYDROMAS- SAGE	L W H	173 cm 78 cm 81 cm	1,09 m ³	37 Kg	49 Kg	1
	S0	L W H	173 cm 78 cm 81 cm	1,09 m ³	52 Kg	64 Kg	1
	SX1	L W H	173 cm 78 cm 81 cm	1,09 m ³	53 Kg	65 Kg	1
	SX2	L W H	173 cm 78 cm 81 cm	1,09 m ³	53 Kg	65 Kg	1
	SX3	L W H	173 cm 78 cm 81 cm	1,09 m ³	60 Kg	72 Kg	1
	SX4	L W H	173 cm 78 cm 81 cm	1,09 m ³	65 Kg	77 Kg	1
	SX5	L W H	173 cm 78 cm 81 cm	1,09 m ³	53 Kg	65 Kg	1

SOLEIL SINGLE

bathtubs - baignoires

PACKAGING DETAILS • DONNÉES D'EXPÉDITION

		DIMENSIONS DIMENSIONS		VOLUME VOLUME	NET WEIGHT / PIECE POIDS NET / PIÈCE	GROSS WEIGHT / PALLET POIDS BRUT / PALETTE	PIECES / PALLET PIÈCES / PALETTE
180x80	BASIC	L W H	130 cm 82 cm 140 cm	1,50 m ³	29 Kg	310 Kg	10
	BATH WITH FRAME CHASSIS SANS HYDROMAS- SAGE	L W H	183 cm 83 cm 81 cm	1,23 m ³	38 Kg	50 Kg	1
	S0	L W H	183 cm 83 cm 81 cm	1,23 m ³	53 Kg	65 Kg	1
	SX1	L W H	183 cm 83 cm 81 cm	1,23 m ³	54 Kg	66 Kg	1
	SX2	L W H	183 cm 83 cm 81 cm	1,23 m ³	54 Kg	66 Kg	1
	SX3	L W H	183 cm 83 cm 81 cm	1,23 m ³	61 Kg	73 Kg	1
	SX4	L W H	183 cm 83 cm 81 cm	1,23 m ³	66 Kg	78 Kg	1
	SX5	L W H	183 cm 83 cm 81 cm	1,23 m ³	54 Kg	66 Kg	1

SOLEIL SINGLE

bathtubs - baignoires

SOLEIL SINGLE 160x70 cm.



left
gauche



right
droite

Water volume 203 l.
Volume d'eau 203 l.

		FINISH FINITION	BRASSWARE ROBINETTERIE	SAP	KEA	€
BASIC			(1)	100096495	N710000526	528,00 €
			(2)	100096498	N710000652	1.598,00 €
BATH WITH FRAME CHASSIS SANS HYDROMASSAGE			-	100096499	N710000595	1.094,00 €
			(2)	100096500	N710000586	2.217,00 €
S0		right droite	-	100096501	N710000578	2.316,00 €
			(2)	100096502	N710000640	3.404,00 €
		left gauche	-	100096503	N710000663	2.316,00 €
			(2)	100096504	N710000572	3.404,00 €
SX1		right droite	-	100096305	N710000441	3.377,00 €
			(2)	100096330	N710000550	4.291,00 €
		left gauche	-	100096306	N710000515	3.377,00 €
			(2)	100096331	N710000543	4.291,00 €
SX2		right droite	-	100096307	N710000489	3.797,00 €
			(2)	100096332	N710000639	4.546,00 €
		left gauche	-	100096308	N710000524	3.797,00 €
			(2)	100096333	N710000470	4.546,00 €
SX3		right droite	-	100096309	N710000468	4.909,00 €
			(2)	100096334	N710000464	6.029,00 €
		left gauche	-	100096310	N710000349	4.909,00 €
			(2)	100096335	N710000497	6.029,00 €
SX4 (4)		right droite	-	100096311	N710000447	7.759,00 €
			(2)	100096336	N710000604	8.936,00 €
		left gauche	-	100096312	N710000659	7.759,00 €
			(2)	100096337	N710000629	8.936,00 €
SX5 (4)		right droite	-	100096313	N710000583	5.596,00 €
			(2)	100096338	N710000514	6.346,00 €
		left gauche	-	100096314	N710000533	5.596,00 €
			(2)	100096339	N710000466	6.346,00 €



(1) Bath waste not included • Vidage non inclus

(2) Bath waste and overflow set included • Vidage automatique inclus





























(3) Bath waste and overflow set included with filler • Vidage automatique avec bec verseur

(4) Make sure that all the important equipment and LED lights can be easily accessed
Ne doit pas être encastrée sans possibilité d'accéder aux spots

SOLEIL SINGLE

bathtubs - baignoires

ACCESSORIES • ACCESSOIRES

	DESCRIPTION DESCRIPTION	COLOUR COULEUR	SAP	KEA	€	BASIC	FRAME CHASSIS	S0	SX1	SX2	SX3	SX4	SX5
	⁽¹⁾ Bath waste and overflow set NEXT + Syphon • Vidage automatique NEXT + Syphon		100060498	N780000002	51,00 €	✓	✓	✓					
	⁽¹⁾ NEXT bath filler waste and overflow set including bath trap • Vidage NEXT avec bec verseur + Syphon		100060521	N780000008	130,00 €	✓	✓	✓					
	COLD head rest • Appui-tête COLD		100066186	N770000052	91,00 €	✓	✓	✓	✓	✓	✓	✓	✓
			100056383	N770000007	239,00 €								
	ENJOY head rest • Appui-tête ENJOY		100056384	N770000034	239,00 €	✓	✓	✓	✓	✓	✓	✓	✓
			100056387	N770000017	239,00 €								
	ENJOY "S" head rest • Appui-tête ENJOY "S"		100060780	N770000049	198,00 €								
			100060753	N770000065	198,00 €	✓	✓	✓	✓	✓	✓	✓	✓
			100060767	N770000057	198,00 €								
	⁽²⁾ Set of CASUAL PLUS support frame with feet • Kit châssis universel CASUAL PLUS		100060499	N770000066	49,00 €	✓							
	⁽³⁾ Bath access panel • Trappe de visite baignoire		250021559	N790001316	331,00 €	✓	✓	✓	✓	✓	✓	✓	✓
	MODUL panel 160 • 160 Tablier MODUL		100056215	N770000002	188,00 €		✓	✓	✓	✓	✓	✓	✓
	MODUL panel 70 • 70 tablier MODUL		100056218	N770000152	111,00 €		✓	✓	✓	✓	✓	✓	✓
			100056093	N770000121	331,00 €								
	CLUB panel 160 • 160 Tablier CLUB		100056095	N770000135	356,00 €		✓	✓	✓	✓	✓	✓	✓
			100056094	N770000138	384,00 €								
			100056075	N770000113	176,00 €								
	CLUB panel 70 • 70 Tablier CLUB		100056077	N770000132	191,00 €		✓	✓	✓	✓	✓	✓	✓
			100056076	N770000114	203,00 €								

⁽¹⁾ Only required for the models not including brassware • Nécessaire uniquement pour les modèles sans robinetterie

⁽²⁾ Recommended use of 2 sets • On recommande 2 jeux pour ce modèle

⁽³⁾ Required for all built-in installations • Nécessaire pour tous les modèles encastrés

SOLEIL SINGLE

bathtubs - baignoires

SOLEIL SINGLE 170x75 cm.



left
gauche



right
droite

Water volume 241 l.
Volume d'eau 241 l.

		FINISH FINITION	BRASSWARE ROBINETTERIE	SAP	KEA	€
BASIC			(1)	100096496	N710000542	574,00 €
			(2)	100096505	N710000743	1.629,00 €
BATH WITH FRAME CHASSIS SANS HYDROMAS- SAGE			-	100096506	N710000532	1.127,00 €
			(2)	100096507	N710000548	2.250,00 €
S0		right droite		100096508	N710000530	2.340,00 €
			(2)	100096509	N710000684	3.428,00 €
		left gauche		100096510	N710000522	2.340,00 €
			(2)	100096511	N710000600	3.428,00 €
SX1		right droite		100096315	N710000633	3.397,00 €
			(2)	100096340	N710000539	4.313,00 €
		left gauche		100096341	N710000540	3.397,00 €
			(2)	100096342	N710000474	4.313,00 €
SX2		right droite		100096316	N710000547	3.820,00 €
			(2)	100096343	N710000476	4.569,00 €
		left gauche		100096344	N710000687	3.820,00 €
			(2)	100096345	N710000660	4.569,00 €
SX3		right droite		100096346	N710000511	4.931,00 €
			(2)	100096347	N710000483	6.052,00 €
		left gauche		100096348	N710000549	4.931,00 €
			(2)	100096349	N710000512	6.052,00 €
SX4 (4)		right droite		100096350	N710000493	7.783,00 €
			(2)	100096351	N710000509	8.961,00 €
		left gauche		100096352	N710000653	7.783,00 €
			(2)	100096353	N710000473	8.961,00 €
SX5 (4)		right droite		100096354	N710000537	5.620,00 €
			(2)	100096355	N710000414	6.369,00 €
		left gauche		100096356	N710000500	5.620,00 €
			(2)	100096357	N710000440	6.369,00 €



(1) Bath waste not included • Vidage non inclus

(2) Bath waste and overflow set included • Vidage automatique inclus





























(3) Bath waste and overflow set included with filler • Vidage automatique avec bec verseur

(4) Make sure that all the important equipment and LED lights can be easily accessed
Ne doit pas être encastrée sans possibilité d'accéder aux spots

SOLEIL SINGLE

bathtubs - baignoires

ACCESSORIES • ACCESSOIRES

	DESCRIPTION DESCRIPTION	COLOUR COULEUR	SAP	KEA	€	BASIC	FRAME CHASSIS	S0	SX1	SX2	SX3	SX4	SX5
	⁽¹⁾ Bath waste and overflow set NEXT + Syphon • Vidage automatique NEXT + Syphon		100060498	N780000002	51,00 €	✓	✓	✓					
	⁽¹⁾ NEXT bath filler waste and overflow set including bath trap • Vidage NEXT avec bec verseur + Syphon		100060521	N780000008	130,00 €	✓	✓	✓					
	COLD head rest • Appui-tête COLD		100066186	N770000052	91,00 €	✓	✓	✓	✓	✓	✓	✓	✓
			100056383	N770000007	239,00 €								
	ENJOY head rest • Appui-tête ENJOY		100056384	N770000034	239,00 €	✓	✓	✓	✓	✓	✓	✓	✓
			100056387	N770000017	239,00 €								
	ENJOY "S" head rest • Appui-tête ENJOY "S"		100060780	N770000049	198,00 €								
			100060753	N770000065	198,00 €	✓	✓	✓	✓	✓	✓	✓	✓
			100060767	N770000057	198,00 €								
	⁽²⁾ Set of CASUAL PLUS support frame with feet • Kit châssis universel CASUAL PLUS		100060499	N770000066	49,00 €	✓							
	⁽³⁾ Bath access panel • Trappe de visite baignoire		250021559	N790001316	331,00 €	✓	✓	✓	✓	✓	✓	✓	✓
	MODUL panel 170 • 170 Tablier MODUL		100056216	N770000146	188,00 €		✓	✓	✓	✓	✓	✓	✓
	MODUL panel 75 • 75 tablier MODUL		100056217	N770000157	111,00 €		✓	✓	✓	✓	✓	✓	✓
			100056096	N770000144	341,00 €								
	CLUB panel 170 • 170 Tablier CLUB		100056098	N770000140	368,00 €		✓	✓	✓	✓	✓	✓	✓
			100056097	N770000145	398,00 €								
			100056078	N770000116	180,00 €								
	CLUB panel 75 • 75 Tablier CLUB		100056080	N770000120	192,00 €		✓	✓	✓	✓	✓	✓	✓
			100056079	N770000142	205,00 €								

⁽¹⁾ Only required for the models not including brassware • Nécessaire uniquement pour les modèles sans robinetterie

⁽²⁾ Recommended use of 2 sets • On recommande 2 jeux pour ce modèle

⁽³⁾ Required for all built-in installations • Nécessaire pour tous les modèles encastrés

SOLEIL SINGLE

bathtubs - baignoires

SOLEIL SINGLE 180x80 cm.

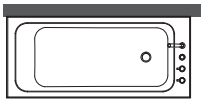

left
gauche



right
droite

Water volume 285 l.
Volume d'eau 285 l.

		FINISH FINITION	BRASSWARE ROBINETTERIE	SAP	KEA	€
BASIC			(1)	100096497	N710000647	623,00 €
			(2)	100096512	N710000479	1.681,00 €
BATH WITH FRAME CHASSIS SANS HYDROMASSAGE			-	100096513	N710000610	1.231,00 €
			(2)	100096514	N710000545	2.305,00 €
S0		right droite	-	100096515	N710000622	2.367,00 €
			(2)	100096516	N710000831	3.459,00 €
		left gauche	-	100096517	N710000535	2.367,00 €
			(2)	100096518	N710000686	3.459,00 €
SX1		right droite	-	100096358	N710000518	3.459,00 €
			(2)	100096359	N710000517	4.379,00 €
		left gauche	-	100096360	N710000558	3.459,00 €
			(2)	100096361	N710000575	4.379,00 €
SX2		right droite	-	100096362	N710000480	3.888,00 €
			(2)	100096363	N710000555	4.638,00 €
		left gauche	-	100096364	N710000565	3.888,00 €
			(2)	100096365	N710000529	4.638,00 €
SX3		right droite	-	100096366	N710000538	4.993,00 €
			(2)	100096367	N710000668	6.119,00 €
		left gauche	-	100096368	N710000531	4.993,00 €
			(2)	100096369	N710000745	6.119,00 €
SX4 (4)		right droite	-	100096370	N710000593	7.856,00 €
			(2)	100096371	N710000623	9.038,00 €
		left gauche	-	100096372	N710000627	7.856,00 €
			(2)	100096373	N710000577	9.038,00 €
SX5 (4)		right droite	-	100096374	N710000674	5.688,00 €
			(2)	100096375	N710000546	6.437,00 €
		left gauche	-	100096376	N710000534	5.688,00 €
			(2)	100096377	N710000618	6.437,00 €



(1) Bath waste not included • Vidage non inclus

(2) Bath waste and overflow set included • Vidage automatique inclus





























(3) Bath waste and overflow set included with filler • Vidage automatique avec bec verseur

(4) Make sure that all the important equipment and LED lights can be easily accessed
Ne doit pas être encastrée sans possibilité d'accéder aux spots

SOLEIL SINGLE

bathtubs - baignoires

ACCESSORIES • ACCESSOIRES

	DESCRIPTION DESCRIPTION	COLOUR COULEUR	SAP	KEA	€	BASIC	FRAME CHASSIS	S0	SX1	SX2	SX3	SX4	SX5
	⁽¹⁾ Bath waste and overflow set NEXT + Syphon • Vidage automatique NEXT + Syphon		100060498	N780000002	51,00 €	✓	✓	✓					
	⁽¹⁾ NEXT bath filler waste and overflow set including bath trap • Vidage NEXT avec bec verseur + Syphon		100060521	N780000008	130,00 €	✓	✓	✓					
	COLD head rest • Appui-tête COLD		100066186	N770000052	91,00 €	✓	✓	✓	✓	✓	✓	✓	✓
			100056383	N770000007	239,00 €								
	ENJOY head rest • Appui-tête ENJOY		100056384	N770000034	239,00 €	✓	✓	✓	✓	✓	✓	✓	✓
			100056387	N770000017	239,00 €								
	ENJOY "S" head rest • Appui-tête ENJOY "S"		100060780	N770000049	198,00 €								
			100060753	N770000065	198,00 €	✓	✓	✓	✓	✓	✓	✓	✓
			100060767	N770000057	198,00 €								
	⁽²⁾ Set of CASUAL PLUS support frame with feet • Kit châssis universel CASUAL PLUS		100060499	N770000066	49,00 €	✓							
	⁽³⁾ Bath access panel • Trappe de visite baignoire		250021559	N790001316	331,00 €	✓	✓	✓	✓	✓	✓	✓	✓
	MODUL panel 180 • 180 Tablier MODUL		100056222	N770000153	220,00 €		✓	✓	✓	✓	✓	✓	✓
	MODUL panel 80 • 80 tablier MODUL		100056219	N770000150	111,00 €		✓	✓	✓	✓	✓	✓	✓
			100056099	N770000130	354,00 €								
	CLUB panel 180 • 180 Tablier CLUB		100056101	N770000133	383,00 €		✓	✓	✓	✓	✓	✓	✓
			100056100	N770000118	414,00 €								
			100056081	N770000117	184,00 €								
	CLUB panel 80 • 80 Tablier CLUB		100056083	N770000136	196,00 €		✓	✓	✓	✓	✓	✓	✓
			100056082	N770000124	211,00 €								

⁽¹⁾ Only required for the models not including brassware • Nécessaire uniquement pour les modèles sans robinetterie

⁽²⁾ Recommended use of 2 sets • On recommande 2 jeux pour ce modèle

⁽³⁾ Required for all built-in installations • Nécessaire pour tous les modèles encastrés