

SOLEIL ROUND

bathtubs - baignoires



bathtubs / baignoires SOLEIL ROUND

COLOURS • COULEURS

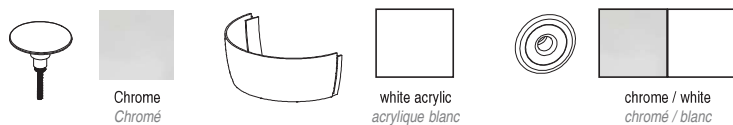

ACCESSORIES • ACCESSOIRES

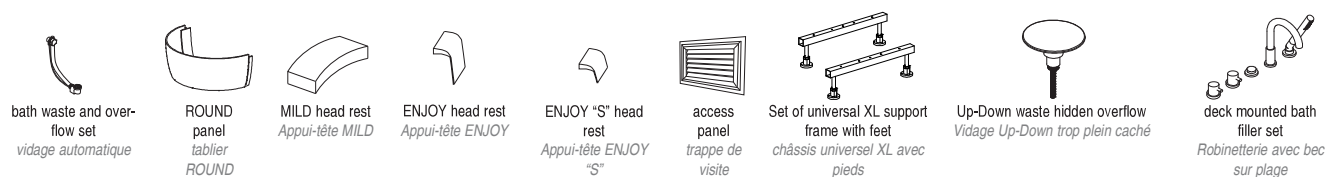

SIZES cm. • FORMATS cm.

Ø170 • 68h

SOLEIL ROUND

bathtubs - baignoires

EQUIPMENT • EQUIPEMENT

		S0	SX1	SX2	SX3	SX4	SX5
JETS		10	-	12	12	12	-
BLOWERS		-	12	-	12	12	12
CHROMOTHERAPY CHROMOTHERAPIE		-	-	-	-	12	12
DISINFECTION DÉSINFECTION		-	-	-	-	✓	-

See features on page 22-25.

Consultez caractéristiques en page 22-25.

DRAWINGS mm. • PLANS mm.

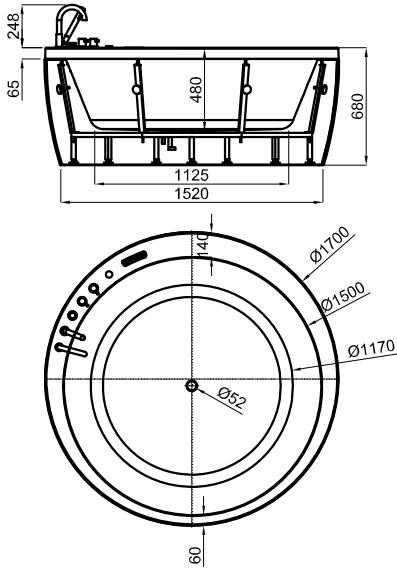

PRE-INSTALLING • PRE-INSTALLATION

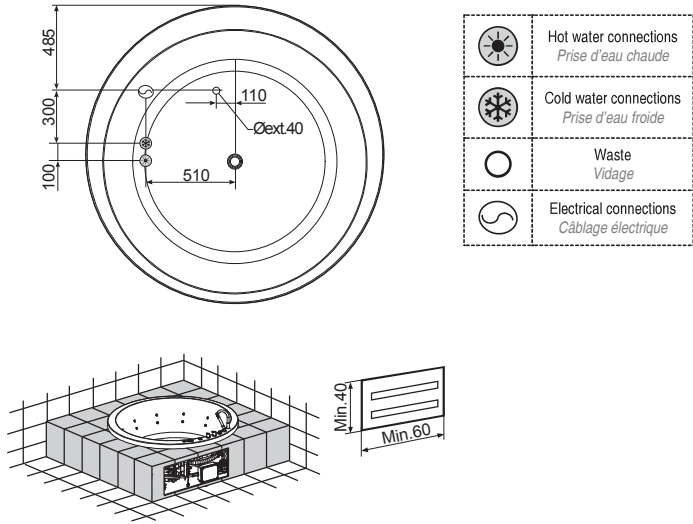

PACKAGING DETAILS • DONNÉES D'EXPÉDITION

	DIMENSIONS DIMENSIONS		VOLUME VOLUME	NET WEIGHT / PIECE POIDS NET / PIÈCE	GROSS WEIGHT / PALLET POIDS BRUT / PALETTE	PIECES / PALLET PIÈCES / PALETTE
BASIC	L	180 cm	4,54 m³	53 Kg	550 Kg	10
	W	180 cm				
	H	140 cm				
BATH WITH FRAME CHASSIS SANS HYDROMASSAGE	L	180 cm	3,08 m³	87 Kg	138,5 Kg	1
	W	180 cm				
	H	95 cm				
S0	L	180 cm	3,08 m³	104,7 Kg	156,2 Kg	1
	W	180 cm				
	H	95 cm				
SX1	L	180 cm	3,08 m³	98,5 Kg	150 Kg	1
	W	180 cm				
	H	95 cm				
SX2	L	180 cm	3,08 m³	101,5 Kg	153 Kg	1
	W	180 cm				
	H	95 cm				
SX3	L	180 cm	3,08 m³	113,5 Kg	165 Kg	1
	W	180 cm				
	H	95 cm				
SX4	L	180 cm	3,08 m³	116,5 Kg	168 Kg	1
	W	180 cm				
	H	95 cm				
SX5	L	180 cm	3,08 m³	99 Kg	150,5 Kg	1
	W	180 cm				
	H	95 cm				

SOLEIL ROUND

bathtubs - baignoires

SOLEIL ROUND Ø170 cm.

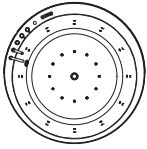

Water volume 500 l.
Volume d'eau 500 l.

		FINISH FINITION	BRASSWARE ROBINETTERIE	SAP	KEA	€
BASIC			(1)	100078588	N710000237	2.586,00 €
			(2)	100078406	N710000230	3.563,00 €
BATH WITH FRAME CHASSIS SANS HYDROMASSAGE		built-in encastrement	-	100078411	N710000325	4.660,00 €
			(3)	100078412	N710000293	5.595,00 €
			-	100078407	N710000288	6.188,00 €
			(3)	100078408	N710000279	7.123,00 €
S0		built-in encastrement	-	100078590	N710000274	5.701,00 €
			(2)	100078416	N710000181	6.695,00 €
			-	100078589	N710000194	7.917,00 €
			(2)	100078413	N710000266	8.913,00 €
SX1		built-in encastrement	-	100078421	N710000332	7.159,00 €
			(3)	100078422	N710000268	8.094,00 €
			-	100078417	N710000200	8.688,00 €
			(3)	100078418	N710000297	9.623,00 €
SX2		built-in encastrement	-	100078428	N710000244	7.346,00 €
			(3)	100078429	N710000311	8.282,00 €
			-	100078423	N710000270	8.875,00 €
			(3)	100078424	N710000317	9.810,00 €
SX3		built-in encastrement	-	100078434	N710000359	9.141,00 €
			(3)	100078435	N710000310	10.076,00 €
			-	100078430	N710000261	10.668,00 €
			(3)	100078431	N710000205	11.603,00 €
SX4 ⁽⁴⁾			-	100078436	N710000265	12.958,00 €
			(3)	100078437	N710000302	13.894,00 €
SX5 ⁽⁴⁾			-	100078440	N710000225	10.477,00 €
			(3)	100078441	N710000189	11.412,00 €



⁽¹⁾ Bath waste not included • Vidage non inclus

⁽²⁾ Deck mounted bath filler set, Bath waste and overflow set included • Robinetterie avec bec sur plage, Vidage automatique inclus

⁽³⁾ Deck mounted bath filler set • Robinetterie avec bec sur plage



















- Up-Down waste hidden overflow • Vidage Up-Down trop plein caché

⁽⁴⁾ Make sure that all the important equipment and LED lights can be easily accessed
Ne doit pas être encastrée sans possibilité d'accéder aux spots

SOLEIL ROUND

bathbubs - baignoires

ACCESSORIES • ACCESSOIRES

	DESCRIPTION DESCRIPTION	COLOUR COULEUR	SAP	KEA	€	BASIC	FRAME CHASSIS	S0	SX1	SX2	SX3	SX4	SX5
	⁽¹⁾ L-110 NEXT Bath waste and overflow set including bath trap • Vidage automatique NEXT L-110 + Siphon		100080172	N770000154	73,00 €	✓		✓					
	MILD head rest • Appui-tête ENJOY		100066187	N770000050	91,00 €	✓	✓	✓	✓	✓	✓	✓	✓
	ENJOY head rest • Appui-tête ENJOY		100056383	N770000007	239,00 €								
			100056384	N770000034	239,00 €	✓	✓		✓				
			100056387	N770000017	239,00 €								
	ENJOY "S" head rest • Appui-tête ENJOY "S"		100060780	N770000049	198,00 €								
			100060753	N770000065	198,00 €	✓	✓	✓	✓	✓	✓	✓	✓
			100060767	N770000057	198,00 €								
	⁽²⁾ Set of universal support XL frame with feet • Châssis avec jeu de pieds universel		100096848	N710000628	75,00 €	✓							
	⁽³⁾ Bath access panel • Trappe de visite baignoire		250021559	N790001316	331,00 €	✓	✓	✓	✓	✓	✓		

⁽¹⁾ Only required for the models not including brassware • Nécessaire uniquement pour les modèles sans robinetterie

⁽²⁾ Recommended use of 2 sets • On recommande 2 jeux pour ce modèle

⁽³⁾ Required for all built-in installations • Nécessaire pour tous les modèles encastrés