

SOLEIL QUADRA

bathtubs - baignoires



bathtubs / baignoires SOLEIL QUADRA

COLOURS • COULEURS

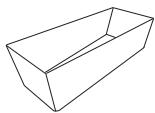

white acrylic
acrylique blanc



chrome / white
chromé / blanc



Chrome
Chromé

ACCESSORIES • ACCESSOIRES



ENJOY head rest
Appui-tête ENJOY



ENJOY "S" head rest
Appui-tête ENJOY "S"



COLD head rest
appui-tête COLD

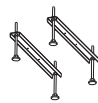

Set of CASUAL PLUS
support frame with feet
châssis universel CASUAL
PLUS

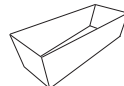

QUADRA panel
tablier QUADRA



access panel
trappe de visite



bath waste and
overflow set
vidage automatique



deck mounted bath filler set
Robinetterie avec bec sur
plage

SIZES cm. • FORMATS cm.

180 x 80 • 60h

EQUIPMENT • EQUIPEMENT

		S0	SX1	SX2	SX3	SX4	SX5
JETS		6	-	10	10	10	-
BLOWERS		-	9	-	9	9	9
CHROMOTHERAPY CHROMOTHERAPIE		-	-	-	-	10	10
DISINFECTION DÉSINFECTION		-	-	-	-	✓	-

See features on page 22-25.
Consultez caractéristiques en page 22-25.

DRAWINGS mm. • PLANS mm.

CENTER (SX)

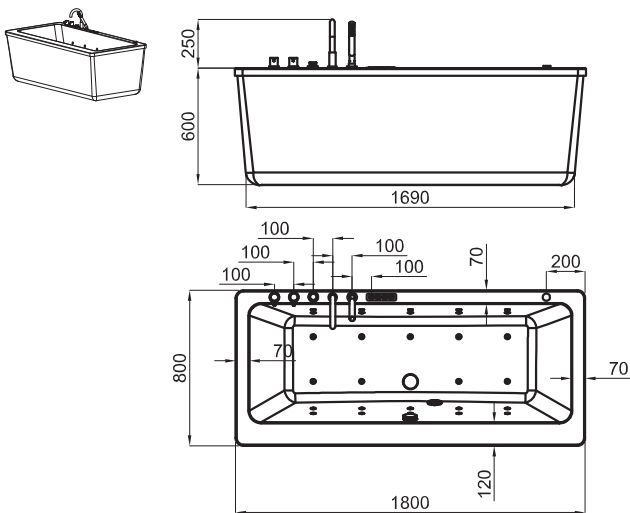

BUILT-IN • ENCASTREMENT

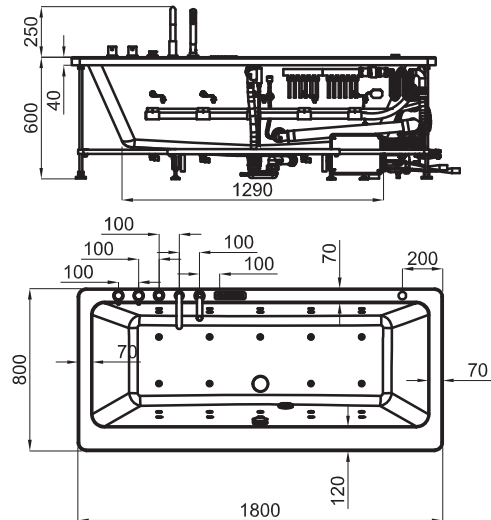

PRE-INSTALLING • PRE-INSTALLATION

CENTER (SX)

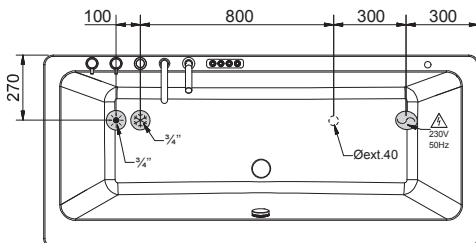

BUILT-IN • ENCASTREMENT

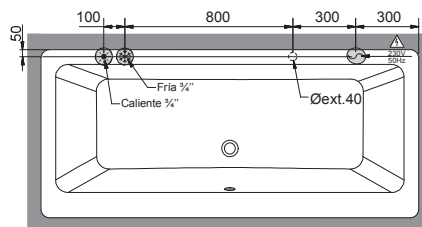

	Hot water connections Prise d'eau chaude
	Cold water connections Prise d'eau froide
	Waste Vidage
	Electrical connections Câblage électrique

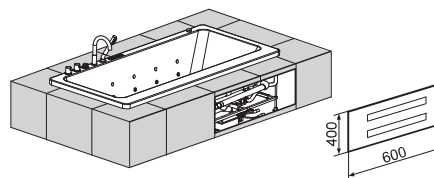

PACKAGING DETAILS • DONNÉES D'EXPÉDITION

	DIMENSIONS DIMENSIONS		VOLUME VOLUME	NET WEIGHT / PIECE POIDS NET / PIÈCE	GROSS WEIGHT / PALLET POIDS BRUT / PALETTE	PIECES / PALLET PIÈCES / PALETTE
BASIC	L W H	120 cm 87 cm 200 cm	2,09 m ³	35,2 Kg	301,4 Kg	8
BATH WITH FRAME CHASSIS SANS HYDROMAS- SAGE	L W H	184 cm 84 cm 82 cm	1,27 m ³	60,1 Kg	77 Kg	1
S0	L W H	184 cm 84 cm 82 cm	1,27 m ³	71,6 Kg	88,5 Kg	1
SX1	L W H	184 cm 84 cm 82 cm	1,27 m ³	69,1 Kg	86 Kg	1
SX2	L W H	184 cm 84 cm 82 cm	1,27 m ³	93,6 Kg	110,5 Kg	1
SX3	L W H	184 cm 84 cm 82 cm	1,27 m ³	102,6 Kg	119,5 Kg	1
SX4	L W H	184 cm 84 cm 82 cm	1,27 m ³	105,6 Kg	122,5 Kg	1
SX5	L W H	184 cm 84 cm 82 cm	1,27 m ³	70,1 Kg	87 Kg	1

SOLEIL QUADRA

bathtubs - baignoires

SOLEIL QUADRA 180x80 cm.

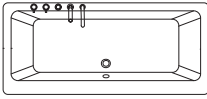

Water volume 214 l.
Volume d'eau 214 l.

		FINISH FINITION	BRASSWARE ROBINETTERIE	SAP	KEA	€
BASIC			(1)	100050674	N71000033	709,00 €
			(2)	100050676	N71000043	2.141,00 €
BATH WITH FRAME CHASSIS SANS HYDROMASSAGE		built-in encastrément	(1)	100084751	N710000478	1.558,00 €
			(2)	100084752	N710000402	4.772,00 €
			(3)	100050673	N71000010	3.313,00 €
			(3)	100050675	N71000042	4.772,00 €
S0		built-in encastrément	(1)	100078688	N710000260	2.334,00 €
			(2)	100078653	N710000241	3.110,00 €
			(3)	100078689	N710000322	4.903,00 €
			(3)	100078654	N710000263	5.679,00 €
SX1		built-in encastrément	(2)	100078655	N710000195	3.887,00 €
			(2)	100078656	N710000327	4.662,00 €
			(3)	100078657	N710000240	7.092,00 €
			(3)	100078658	N710000277	7.868,00 €
SX2		built-in encastrément	(2)	100078659	N710000214	3.970,00 €
			(2)	100078660	N710000304	4.747,00 €
			(3)	100078661	N710000321	6.401,00 €
			(3)	100078662	N710000367	7.177,00 €
SX3		built-in encastrément	(2)	100078663	N710000276	5.766,00 €
			(2)	100078664	N710000287	6.542,00 €
			(3)	100078665	N710000307	8.196,00 €
			(3)	100078666	N710000228	8.972,00 €
SX4 ⁽⁴⁾			(3)	100078667	N710000323	10.299,00 €
			(3)	100078668	N710000291	11.075,00 €
SX5 ⁽⁴⁾			(3)	100078669	N710000375	8.106,00 €
			(3)	100078670	N710000305	8.881,00 €



⁽¹⁾ Bath waste not included • Vidage non inclus

⁽²⁾ Deck mounted bath filler set, Bath waste and overflow set included • Robinetterie avec bec sur plage, Vidage automatique inclus

















⁽³⁾ Deck mounted bath filler set • Robinetterie avec bec sur plage

⁽⁴⁾ Make sure that all the important equipment and LED lights can be easily accessed
Ne doit pas être encastrée sans possibilité d'accéder aux spots

SOLEIL QUADRA

bathtubs - baignoires

ACCESSORIES • ACCESSOIRES

	DESCRIPTION DESCRIPTION	COLOUR COULEUR	SAP	KEA	€	BASIC	FRAME CHASSIS	S0	SX1	SX2	SX3	SX4	SX5
	⁽¹⁾ Bath waste and overflow set NEXT + Syphon • Vidage automatique NEXT + Syphon		100060498	N780000002	51,00 €	✓	✓	✓					
	COLD head rest • Appui-tête COLD		100066186	N770000052	91,00 €	✓	✓	✓	✓	✓	✓	✓	✓
	ENJOY head rest • Appui-tête ENJOY		100056383	N770000007	239,00 €								
			100056384	N770000034	239,00 €	✓	✓	✓	✓	✓	✓	✓	✓
			100056387	N770000017	239,00 €								
	ENJOY "S" head rest • Appui-tête ENJOY "S"		100060780	N770000049	198,00 €								
			100060753	N770000065	198,00 €	✓	✓	✓	✓	✓	✓	✓	✓
			100060767	N770000057	198,00 €								
	⁽²⁾ Set of CASUAL PLUS support frame with feet • Kit châssis universel CASUAL PLUS		100060499	N770000066	49,00 €	✓							
	⁽³⁾ Bath access panel • Trappe de visite baignoire		250021559	N790001316	331,00 €	✓	✓	✓	✓	✓	✓		

⁽¹⁾ Only required for the models not including brassware • Nécessaire uniquement pour les modèles sans robinetterie

⁽²⁾ Recommended use of 2 sets • On recommande 2 jeux pour ce modèle

⁽³⁾ Required for all built-in installations • Nécessaire pour tous les modèles encastrés