

MINIMAL XL

bathtubs - baignoires



bathtubs / baignoires MINIMAL XL

COLOURS • COULEURS



CLUB panel
tablier CLUB



white
blanc



black
noir



Inox



MODUL panel
tablier MODUL



white
blanc



chrome / white
chromé / blanc



Chrome
Chromé

ACCESSORIES • ACCESSOIRES



ENJOY head rest
Appui-tête ENJOY



ENJOY "S" head rest
Appui-tête ENJOY "S"



COLD head rest
appui-tête COLD



Set of universal support
frame with feet CASUAL
châssis universel
CASUAL



CLUB panel
tablier CLUB



MODUL panel
tablier MODUL



access panel
trappe de visite



bath waste and
overflow set
vidage automatique



bath filler waste and over-
flow set
automatique vidage bec
verseur



deck mounted valves and
handset
robinetterie

MINIMAL XL

bathtubs - baignoires

SIZES cm. • FORMATS cm.

170 x 70 • 61h
 170 x 75 • 61h
 170 x 80 • 61h
 180 x 80 • 61h
 190 x 90 • 61h

EQUIPMENT • EQUIPEMENT

		S0	SX1	SX2	SX3	SX4	SX5
JETS		6	-	10	10	10	-
BLOWERS		-	9	-	9	9	9
CHROMOTHERAPY CHROMOTHERAPIE		-	-	-	-	10	10
DISINFECTION DÉSINFECTION		-	-	-	-	✓	-

See features on page 22-25.

Consultez caractéristiques en page 22-25.

DRAWINGS mm. • PLANS mm.

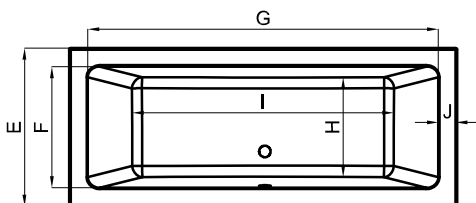
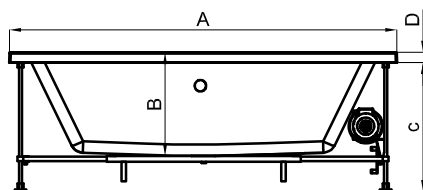

mm	A	B	C	D	E	F	G	H	I	J
1700 x 700	1700	450	565	45	700	540	1540	440	1140	80
1700 x 750	1700	470	565	45	750	600	1540	490	1140	80
1700 x 800	1700	470	565	45	800	640	1540	540	1140	80
1800 x 800	1800	470	565	45	800	640	1640	540	1240	80
1900 x 900	1900	470	565	45	900	740	1740	640	1340	80

PRE-INSTALLING • PRE-INSTALLATION

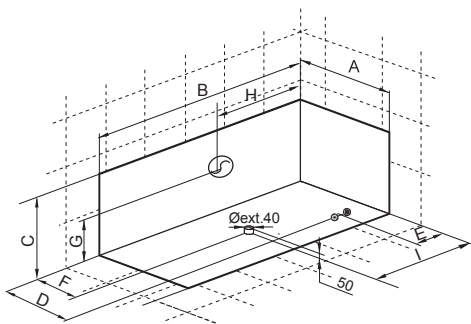

Left
Gauche

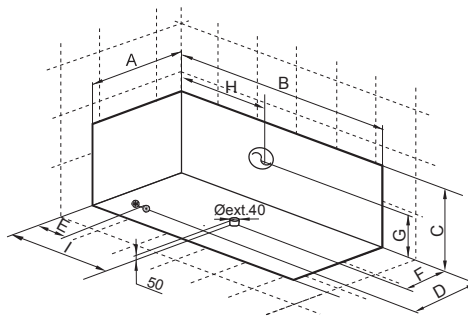

Right
Droite

	Hot water connections Prise d'eau chaude
	Cold water connections Prise d'eau froide
	Waste Vidage
	Electrical connections Câblage électrique

mm	A	B	C	D	E	F	G	H	I
1700 x 700	700	1700	610	465	250	350	300	850	850
1700 x 750	750	1700	610	500	250	375	300	850	850
1700 x 800	800	1700	610	535	250	400	300	850	850
1800 x 800	800	1800	610	535	250	400	300	900	900
1900 x 900	900	1900	610	600	250	450	300	950	950

PACKAGING DETAILS • DONNÉES D'EXPÉDITION

		DIMENSIONS DIMENSIONS		VOLUME VOLUME	NET WEIGHT / PIECE POIDS NET / PIÈCE	GROSS WEIGHT / PALLET POIDS BRUT / PALETTE	PIECES / PALLET PIÈCES / PALETTE								
170x70	BASIC	L	120 cm	1,83 m ³	26,3 Kg	245,4 Kg	8								
		W	80 cm												
		H	190 cm												
	BATH WITH FRAME CHASSIS SANS HYDROMAS- SAGE	L	174 cm					0,95 m ³	36,5 Kg	43,5 Kg	1				
		W	79cm												
		H	69 cm												
	S0	L	174 cm									0,95 m ³	46,4 Kg	53,4 Kg	1
		W	79 cm												
	H	69 cm													
SX1	L	174 cm	0,95 m ³	42,4 Kg	49,4 Kg	1									
	W	79cm													
	H	69 cm													
SX2	L	174 cm					0,95 m ³	49,2 Kg	56,2 Kg	1					
	W	79 cm													
	H	69 cm													
SX3	L	174 cm									0,95 m ³	55 Kg	62 Kg	1	
	W	79 cm													
	H	69 cm													
SX4	L	174 cm	0,95 m ³	58 Kg	65 Kg	1									
	W	79 cm													
	H	69 cm													
SX5	L	174 cm					0,95 m ³	43,4 Kg	50,4 Kg	1					
	W	79 cm													
	H	69 cm													
170x75	BASIC	L									120 cm	1,94 m ³	28,0 Kg	259 Kg	8
		W									85 cm				
		H	190 cm												
	BATH WITH FRAME CHASSIS SANS HYDROMAS- SAGE	L	174 cm	0,95 m ³	38,6 Kg	45,6 Kg					1				
		W	79 cm												
		H	69 cm												
	S0	L	174 cm				0,95 m ³	48,5 Kg	55,5 Kg	1					
		W	79 cm												
	H	69 cm													
SX1	L	174 cm	0,95 m ³									44,5 Kg	51,5 Kg	1	
	W	79 cm													
	H	69 cm													
SX2	L	174 cm		0,95 m ³	51,3 Kg	58,3 Kg					1				
	W	79 cm													
	H	69 cm													
SX3	L	174 cm					0,95 m ³	57,5 Kg	64,5 Kg	1					
	W	79 cm													
	H	69 cm													
SX4	L	174 cm	0,95 m ³									60,5 Kg	67,5 Kg	1	
	W	79 cm													
	H	69 cm													
SX5	L	174 cm		0,95 m ³	45,5 Kg	52,5 Kg					1				
	W	79 cm													
	H	69 cm													
170x80	BASIC	L					120 cm	2,1 m ³	30,3 Kg	277,4 Kg					8
		W					90 cm								
		H	190 cm												
	BATH WITH FRAME CHASSIS SANS HYDROMAS- SAGE	L	184 cm				1,07 m ³					40,3 Kg	47,8 Kg	1	
		W	84 cm												
		H	69 cm												
	S0	L	184 cm	1,07 m ³	50,1 Kg	57,6 Kg					1				
		W	84 cm												
	H	69 cm													
SX1	L	184 cm	1,07 m ³					46,1 Kg	53,6 Kg	1					
	W	84 cm													
	H	69 cm													
SX2	L	184 cm					1,07 m ³					53 Kg	60,5 Kg	1	
	W	84 cm													
	H	69 cm													
SX3	L	184 cm		1,07 m ³	52 Kg	59,5 Kg					1				
	W	84 cm													
	H	69 cm													
SX4	L	184 cm	1,07 m ³					55 Kg	62,5 Kg	1					
	W	84 cm													
	H	69 cm													
SX5	L	184 cm					1,07 m ³					47,1 Kg	54,6 Kg	1	
	W	84 cm													
	H	69 cm													

PACKAGING DETAILS • DONNÉES D'EXPÉDITION

		DIMENSIONS DIMENSIONS		VOLUME VOLUME	NET WEIGHT / PIECE POIDS NET / PIÈCE	GROSS WEIGHT / PALLET POIDS BRUT / PALETTE	PIECES / PALLET PIÈCES / PALETTE
180x80	BASIC	L W H	120 cm 90 cm 200 cm	2,2 m³	31,3 Kg	285,4 Kg	8
	BATH WITH FRAME CHASSIS SANS HYDROMASSAGE	L W H	184 cm 84 cm 69 cm	1,07 m³	42,4 Kg	49,9 Kg	1
	S0	L W H	184 cm 84 cm 69 cm	1,07 m³	52,2 Kg	59,7 Kg	1
	SX1	L W H	184 cm 84 cm 69 cm	1,07 m³	48,2 Kg	55,7 Kg	1
	SX2	L W H	184 cm 84 cm 69 cm	1,07 m³	55,1 Kg	62,6 Kg	1
	SX3	L W H	184 cm 84 cm 69 cm	1,07 m³	55,5 Kg	63 Kg	1
	SX4	L W H	184 cm 84 cm 69 cm	1,07 m³	58,5 Kg	66 Kg	1
	SX5	L W H	184 cm 84 cm 69 cm	1,07 m³	49,2 Kg	56,7 Kg	1
190x90	BASIC	L W H	120 cm 100 cm 210 cm	2,52 m³	37,7 Kg	336,6 Kg	8
	BATH WITH FRAME CHASSIS SANS HYDROMASSAGE	L W H	194 cm 94 cm 69cm	1,26 m³	44,4 Kg	52,0 Kg	1
	S0	L W H	194 cm 94 cm 69cm	1,26 m³	54,3 Kg	61,9 Kg	1
	SX1	L W H	194 cm 94 cm 69cm	1,26 m³	50,3 Kg	57,9 Kg	1
	SX2	L W H	194 cm 94 cm 69cm	1,26 m³	57,1 Kg	64,7 Kg	1
	SX3	L W H	194 cm 94 cm 69cm	1,26 m³	65,9 Kg	73,5 Kg	1
	SX4	L W H	194 cm 94 cm 69cm	1,26 m³	68,9 Kg	76,5 Kg	1
	SX5	L W H	194 cm 94 cm 69cm	1,26 m³	51,3 Kg	58,9 Kg	1

MINIMAL XL 170x70 cm.

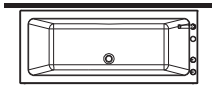
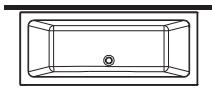

left
gauche

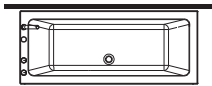

right
droite

Water volume 196 l.
Volume d'eau 196 l.



- ⁽¹⁾ Bath waste not included
Vidage non inclus
- ⁽²⁾ Waste included
Vidage inclus
- ⁽³⁾ Bath waste and overflow set included with filler
Vidage automatique avec bec verseur
- ⁽⁴⁾ Make sure that all the important equipment and LED lights can be easily accessed
Ne doit pas être encastrée sans possibilité d'accéder aux spots

		FINISH FINITION	BRASSWARE ROBINETTERIE	SAP	KEA	€
BASIC		(1)_		100050862	N710000098	536,00 €
		(3)		100050863	N710000104	1.538,00 €
BATH WITH FRAME CHASSIS SANS HYDROMASSAGE		(1)_		100050864	N710000062	1.013,00 €
		(3)		100050865	N710000077	2.034,00 €
S0		(1)_		100050866	N710000065	2.204,00 €
		right droite	(3)		100050867	N710000107
SX1		left gauche	(3)	100050876	N710000069	3.234,00 €
		right droite	(2)_	100102480	N710000748	3.105,00 €
SX2		right droite	(3)	100102481	N710000693	4.022,00 €
		left gauche	(3)	100102482	N710000776	4.022,00 €
SX3		right droite	(2)_	100102483	N710000680	3.454,00 €
		left gauche	(3)	100102484	N710000766	4.255,00 €
SX4 ⁽⁴⁾		right droite	(3)	100102485	N710000648	4.255,00 €
		left gauche	(2)_	100102486	N710000750	4.904,00 €
SX5 ⁽⁴⁾		right droite	(3)	100102487	N710000716	5.712,00 €
		left gauche	(3)	100102488	N710000658	5.712,00 €
SX6 ⁽⁴⁾		right droite	(2)_	100102489	N710000645	7.340,00 €
		left gauche	(3)	100102490	N710000615	8.446,00 €
SX7 ⁽⁴⁾		right droite	(3)	100102491	N710000607	8.446,00 €
		left gauche	(2)_	100102492	N710000765	5.189,00 €
SX8 ⁽⁴⁾		right droite	(3)	100102493	N710000736	6.035,00 €
		left gauche	(3)	100102494	N710000714	6.035,00 €

ACCESSORIES • ACCESSOIRES

	DESCRIPTION DESCRIPTION	COLOUR COULEUR	SAP	KEA	€	BASIC	FRAME CHASSIS	S0	SX1	SX2	SX3	SX4	SX5
	⁽¹⁾ Bath waste and overflow set NEXT + Syphon • <i>Vidage automatique NEXT + Syphon</i>		100060498	N780000002	51,00 €	✓	✓	✓					
	⁽¹⁾ NEXT bath filler waste and overflow set including bath trap • <i>Vidage NEXT avec bec verseur + Syphon</i>		100060521	N780000008	130,00 €	✓	✓	✓					
	COLD head rest • <i>Appui-tête COLD</i>		100066186	N770000052	91,00 €	✓	✓	✓	✓	✓	✓	✓	✓
	ENJOY head rest • <i>Appui-tête ENJOY</i>		100056383	N770000007	239,00 €		✓	✓	✓	✓	✓	✓	✓
	ENJOY "S" head rest • <i>Appui-tête ENJOY "S"</i>		100056384	N770000034	239,00 €	✓	✓	✓	✓	✓	✓	✓	✓
			100056387	N770000017	239,00 €		✓	✓	✓	✓	✓	✓	✓
			100060780	N770000049	198,00 €		✓	✓	✓	✓	✓	✓	✓
			100060753	N770000065	198,00 €	✓	✓	✓	✓	✓	✓	✓	✓
			100060767	N770000057	198,00 €		✓	✓	✓	✓	✓	✓	✓
	⁽²⁾ Set of CASUAL PLUS support frame with feet • <i>Kit châssis universel CASUAL PLUS</i>		100057508	N770000042	39,00 €	✓							
	⁽³⁾ Bath access panel • <i>Trappe de visite baignoire</i>		250021559	N790001316	331,00 €	✓	✓	✓	✓	✓	✓	✓	✓
	MODUL panel 170 • 170 Tablier MODUL		100056216	N770000146	188,00 €		✓	✓	✓	✓	✓	✓	✓
	MODUL panel 70 • 70 tablier MODUL		100056218	N770000152	111,00 €		✓	✓	✓	✓	✓	✓	✓
	CLUB panel 170 • 170 Tablier CLUB		100056096	N770000144	341,00 €			✓	✓	✓	✓	✓	✓
			100056098	N770000140	368,00 €		✓	✓	✓	✓	✓	✓	✓
	CLUB panel 70 • 70 Tablier CLUB		100056097	N770000145	398,00 €			✓	✓	✓	✓	✓	✓
			100056075	N770000113	176,00 €			✓	✓	✓	✓	✓	✓
			100056077	N770000132	191,00 €			✓	✓	✓	✓	✓	✓
			100056076	N770000114	203,00 €			✓	✓	✓	✓	✓	✓

⁽¹⁾ Only required for the models not including brassware • *Nécessaire uniquement pour les modèles sans robinetterie*

⁽²⁾ Recommended use of 2 sets • *On recommande 2 jeux pour ce modèle*

⁽³⁾ Required for all built-in installations • *Nécessaire pour tous les modèles encastrés*

MINIMAL XL

bathubs - baignoires

MINIMAL XL 170x75 cm.

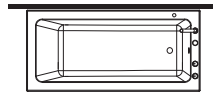
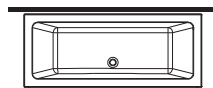

left
gauche



right
droite

Water volume 239 l.
Volume d'eau 239 l.



- ⁽¹⁾ Bath waste not included
Vidage non inclus
- ⁽²⁾ Waste included
Vidage inclus
- ⁽³⁾ Bath waste and overflow set included with filler
Vidage automatique avec bec verseur
- ⁽⁴⁾ Make sure that all the important equipment and LED lights can be easily accessed
Ne doit pas être encastrée sans possibilité d'accéder aux spots

		FINISH FINITION	BRASSWARE ROBINETTERIE	SAP	KEA	€
BASIC			(1)_	100050881	N710000074	543,00 €
		(3)		100050882	N710000078	1.545,00 €
BATH WITH FRAME CHASSIS SANS HYDROMASSAGE			(1)_	100050883	N710000063	1.020,00 €
		(3)		100050884	N710000105	2.041,00 €
S0			(1)_	100050885	N710000066	2.211,00 €
		right droite	(3)	100050886	N710000095	3.241,00 €
		left gauche	(3)	100050895	N710000071	3.241,00 €
SX1			(2)_	100102495	N710000760	3.113,00 €
		right droite	(3)	100102496	N710000646	4.030,00 €
		left gauche	(3)	100102497	N710000632	4.030,00 €
SX2			(2)_	100102498	N710000677	3.466,00 €
		right droite	(3)	100102499	N710000676	4.268,00 €
		left gauche	(3)	100102500	N710000825	4.268,00 €
SX3			(2)_	100102501	N710000690	4.913,00 €
		right droite	(3)	100102502	N710000711	5.719,00 €
		left gauche	(3)	100102503	N710000688	5.719,00 €
SX4 (4)			(2)_	100102504	N710000773	7.347,00 €
		right droite	(3)	100102505	N710000613	8.454,00 €
		left gauche	(3)	100102506	N710000770	8.454,00 €
SX5 (4)			(2)_	100102507	N710000614	5.201,00 €
		right droite	(3)	100102508	N710000780	6.048,00 €
		left gauche	(3)	100102509	N710000598	6.048,00 €

ACCESSORIES • ACCESSOIRES

	DESCRIPTION DESCRIPTION	COLOUR COULEUR	SAP	KEA	€	BASIC	FRAME CHASSIS	S0	SX1	SX2	SX3	SX4	SX5
	⁽¹⁾ Bath waste and overflow set NEXT + Syphon • <i>Vidage automatique NEXT + Syphon</i>		100060498	N780000002	51,00 €	✓	✓	✓					
	⁽¹⁾ NEXT bath filler waste and overflow set including bath trap • <i>Vidage NEXT avec bec verseur + Syphon</i>		100060521	N780000008	130,00 €	✓	✓	✓					
	COLD head rest • <i>Appui-tête COLD</i>		100066186	N770000052	91,00 €	✓	✓	✓	✓	✓	✓	✓	✓
	ENJOY head rest • <i>Appui-tête ENJOY</i>		100056383	N770000007	239,00 €								
			100056384	N770000034	239,00 €	✓	✓	✓	✓	✓	✓	✓	✓
			100056387	N770000017	239,00 €								
	ENJOY "S" head rest • <i>Appui-tête ENJOY "S"</i>		100060780	N770000049	198,00 €								
			100060753	N770000065	198,00 €	✓	✓	✓	✓	✓	✓	✓	✓
			100060767	N770000057	198,00 €								
	⁽²⁾ Set of CASUAL PLUS support frame with feet • <i>Kit châssis universel CASUAL PLUS</i>		100057508	N770000042	39,00 €	✓							
	⁽³⁾ Bath access panel • <i>Trappe de visite baignoire</i>		250021559	N790001316	331,00 €	✓	✓	✓	✓	✓	✓	✓	✓
	MODUL panel 170 • 170 Tablier MODUL		100056216	N770000146	188,00 €		✓	✓	✓	✓	✓	✓	✓
	MODUL panel 75 • 75 tablier MODUL		100056217	N770000157	111,00 €		✓	✓	✓	✓	✓	✓	✓
	CLUB panel 170 • 170 Tablier CLUB		100056096	N770000144	341,00 €								
			100056098	N770000140	368,00 €		✓	✓	✓	✓	✓	✓	✓
			100056097	N770000145	398,00 €								
			100056078	N770000116	180,00 €								
	CLUB panel 75 • 75 Tablier CLUB		100056080	N770000120	192,00 €		✓	✓	✓	✓	✓	✓	✓
			100056079	N770000142	205,00 €		✓	✓	✓	✓	✓	✓	✓

⁽¹⁾ Only required for the models not including brassware • *Nécessaire uniquement pour les modèles sans robinetterie*

⁽²⁾ Recommended use of 2 sets • *On recommande 2 jeux pour ce modèle*

⁽³⁾ Required for all built-in installations • *Nécessaire pour tous les modèles encastrés*

MINIMAL XL

bathtubs - baignoires

MINIMAL XL 170x80 cm.

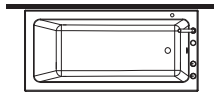
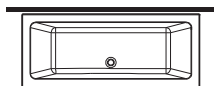

left
gauche

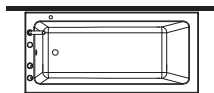

right
droite

Water volume 261 l.
Volume d'eau 261 l.



⁽¹⁾ Bath waste not included
Vidage non inclus

⁽²⁾ Waste included
Vidage inclus

⁽³⁾ Bath waste and overflow set included
with filler

Vidage automatique avec bec verseur

⁽⁴⁾ Make sure that all the important
equipment and LED lights can be easily
accessed

Ne doit pas être encastrée sans
possibilité d'accéder aux spots

		FINISH FINITION	BRASSWARE ROBINETTERIE	SAP	KEA	€	
BASIC			(1)_	100050900	N710000088	590,00 €	
		(3)		100050901	N710000125	1.592,00 €	
BATH WITH FRAME CHASSIS SANS HYDROMAS- SAGE			(1)_	100050902	N710000123	1.072,00 €	
		(3)		100050903	N710000127	2.091,00 €	
S0			(1)_	100050904	N710000106	2.260,00 €	
		right droite	(3)		100050905	N710000075	3.290,00 €
		left gauche	(3)		100050914	N710000092	3.290,00 €
SX1			(2)_	100102510	N710000803	2.894,00 €	
		right droite	(3)		100102511	N710000789	3.969,00 €
		left gauche	(3)		100102512	N710000777	3.969,00 €
SX2			(2)_	100102513	N710000721	3.536,00 €	
		right droite	(3)		100102514	N710000726	4.383,00 €
		left gauche	(3)		100102515	N710000698	4.383,00 €
SX3			(2)_	100102516	N710000611	4.538,00 €	
		right droite	(3)		100102517	N710000654	5.613,00 €
		left gauche	(3)		100102518	N710000729	5.613,00 €
SX4 ⁽⁴⁾			(2)_	100102519	N710000757	7.196,00 €	
		right droite	(3)		100102520	N710000667	8.271,00 €
		left gauche	(3)		100102521	N710000758	8.271,00 €
SX5 ⁽⁴⁾			(2)_	100102522	N710000749	5.271,00 €	
		right droite	(3)		100102523	N710000741	6.118,00 €
		left gauche	(3)		100102524	N710000841	6.118,00 €

ACCESSORIES • ACCESSOIRES

	DESCRIPTION DESCRIPTION	COLOUR COULEUR	SAP	KEA	€	BASIC	FRAME CHASSIS	S0	SX1	SX2	SX3	SX4	SX5
	⁽¹⁾ Bath waste and overflow set NEXT + Syphon • Vidage automatique NEXT + Syphon		100060498	N780000002	51,00 €	✓	✓	✓					
	⁽¹⁾ NEXT bath filler waste and overflow set including bath trap • Vidage NEXT avec bec verseur + Syphon		100060521	N780000008	130,00 €	✓	✓	✓					
	COLD head rest • Appui-tête COLD		100066186	N770000052	91,00 €	✓	✓	✓	✓	✓	✓	✓	✓
	ENJOY head rest • Appui-tête ENJOY		100056383	N770000007	239,00 €								
			100056384	N770000034	239,00 €	✓	✓	✓	✓	✓	✓	✓	✓
			100056387	N770000017	239,00 €								
	ENJOY "S" head rest • Appui-tête ENJOY "S"		100060780	N770000049	198,00 €								
			100060753	N770000065	198,00 €	✓	✓	✓	✓	✓	✓	✓	✓
			100060767	N770000057	198,00 €								
	⁽²⁾ Set of CASUAL PLUS support frame with feet • Kit châssis universel CASUAL PLUS		100060499	N770000066	49,00 €	✓							
	⁽³⁾ Bath access panel • Trappe de visite baignoire		250021559	N790001316	331,00 €	✓	✓	✓	✓	✓	✓	✓	✓
	MODUL panel 170 • 170 Tablier MODUL		100056216	N770000146	188,00 €		✓	✓	✓	✓	✓	✓	✓
	MODUL panel 80 • 80 tablier MODUL		100056218	N770000152	111,00 €		✓	✓	✓	✓	✓	✓	✓
	CLUB panel 170 • 170 Tablier CLUB		100056096	N770000144	341,00 €								
			100056098	N770000140	368,00 €		✓	✓	✓	✓	✓	✓	✓
			100056097	N770000145	398,00 €								
	CLUB panel 80 • 80 Tablier CLUB		100056075	N770000113	184,00 €								
			100056077	N770000132	196,00 €		✓	✓	✓	✓	✓	✓	✓
			100056076	N770000114	211,00 €								

⁽¹⁾ Only required for the models not including brassware • Nécessaire uniquement pour les modèles sans robinetterie

⁽²⁾ Recommended use of 2 sets • On recommande 2 jeux pour ce modèle

⁽³⁾ Required for all built-in installations • Nécessaire pour tous les modèles encastrés

MINIMAL XL

bathtubs - baignoires

MINIMAL XL 180x80 cm.

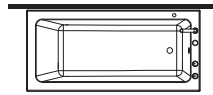
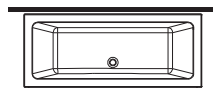

left
gauche



right
droite

Water volume 282 l.
Volume d'eau 282 l.



- ⁽¹⁾ Bath waste not included
Vidage non inclus
- ⁽²⁾ Waste included
Vidage inclus
- ⁽³⁾ Bath waste and overflow set included with filler
Vidage automatique avec bec verseur
- ⁽⁴⁾ Make sure that all the important equipment and LED lights can be easily accessed
Ne doit pas être encastrée sans possibilité d'accéder aux spots

		FINISH FINITION	BRASSWARE ROBINETTERIE	SAP	KEA	€	
BASIC			(1)_	100050919	N710000103	590,00 €	
		(3)		100050920	N710000112	1.592,00 €	
BATH WITH FRAME CHASSIS SANS HYDROMASSAGE			(1)_	100050921	N710000108	1.112,00 €	
		(3)		100050922	N710000100	2.091,00 €	
S0			(1)_	100050923	N710000096	2.260,00 €	
		right droite	(3)		100050924	N710000120	3.290,00 €
		left gauche	(3)		100050933	N710000099	3.290,00 €
SX1			(2)_	100102525	N710000755	2.894,00 €	
		right droite	(3)		100102526	N710000689	3.969,00 €
		left gauche	(3)		100102527	N710000762	3.969,00 €
SX2			(2)_	100102528	N710000793	3.533,00 €	
		right droite	(3)		100102529	N710000719	4.380,00 €
		left gauche	(3)		100102530	N710000715	4.380,00 €
SX3			(2)_	100102531	N710000708	4.538,00 €	
		right droite	(3)		100102532	N710000809	5.613,00 €
		left gauche	(3)		100102533	N710000730	5.613,00 €
SX4 ⁽⁴⁾			(2)_	100102534	N710000756	7.196,00 €	
		right droite	(3)		100102535	N710000772	8.271,00 €
		left gauche	(3)		100102536	N710000728	8.271,00 €
SX5 ⁽⁴⁾			(2)_	100102537	N710000734	5.268,00 €	
		right droite	(3)		100102538	N710000835	6.115,00 €
		left gauche	(3)		100102539	N710000669	6.115,00 €

ACCESSORIES • ACCESSOIRES

	DESCRIPTION DESCRIPTION	COLOUR COULEUR	SAP	KEA	€	BASIC	FRAME CHASSIS	S0	SX1	SX2	SX3	SX4	SX5
	⁽¹⁾ Bath waste and overflow set NEXT + Syphon • <i>Vidage automatique NEXT + Syphon</i>		100060498	N780000002	51,00 €	✓	✓	✓					
	⁽¹⁾ NEXT bath filler waste and overflow set including bath trap • <i>Vidage NEXT avec bec verseur + Syphon</i>		100060521	N780000008	130,00 €	✓	✓	✓					
	COLD head rest • <i>Appui-tête COLD</i>		100066186	N770000052	91,00 €	✓	✓	✓	✓	✓	✓	✓	✓
	ENJOY head rest • <i>Appui-tête ENJOY</i>		100056383	N770000007	239,00 €		✓	✓	✓	✓	✓	✓	✓
			100056384	N770000034	239,00 €	✓	✓	✓	✓	✓	✓	✓	✓
			100056387	N770000017	239,00 €		✓	✓	✓	✓	✓	✓	✓
	ENJOY "S" head rest • <i>Appui-tête ENJOY "S"</i>		100060780	N770000049	198,00 €		✓	✓	✓	✓	✓	✓	✓
			100060753	N770000065	198,00 €	✓	✓	✓	✓	✓	✓	✓	✓
			100060767	N770000057	198,00 €		✓	✓	✓	✓	✓	✓	✓
	⁽²⁾ Set of CASUAL PLUS support frame with feet • <i>Kit châssis universel CASUAL PLUS</i>		100060499	N770000066	49,00 €	✓							
	⁽³⁾ Bath access panel • <i>Trappe de visite baignoire</i>		250021559	N790001316	331,00 €	✓	✓	✓	✓	✓	✓	✓	✓
	MODUL panel 180 • 180 Tablier MODUL		100056222	N770000153	220,00 €		✓	✓	✓	✓	✓	✓	✓
	MODUL panel 80 • 80 tablier MODUL		100056219	N770000150	111,00 €		✓	✓	✓	✓	✓	✓	✓
	CLUB panel 180 • 180 Tablier CLUB		100056099	N770000130	354,00 €		✓	✓	✓	✓	✓	✓	✓
			100056101	N770000133	383,00 €		✓	✓	✓	✓	✓	✓	✓
			100056100	N770000118	414,00 €		✓	✓	✓	✓	✓	✓	✓
			100056081	N770000117	184,00 €		✓	✓	✓	✓	✓	✓	✓
	CLUB panel 80 • 80 Tablier CLUB		100056083	N770000136	196,00 €		✓	✓	✓	✓	✓	✓	✓
			100056082	N770000124	211,00 €		✓	✓	✓	✓	✓	✓	✓

⁽¹⁾ Only required for the models not including brassware • *Nécessaire uniquement pour les modèles sans robinetterie*

⁽²⁾ Recommended use of 2 sets • *On recommande 2 jeux pour ce modèle*

⁽³⁾ Required for all built-in installations • *Nécessaire pour tous les modèles encastrés*

MINIMAL XL

bathtubs - baignoires

MINIMAL XL 190x90 cm.

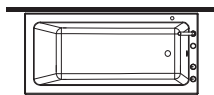
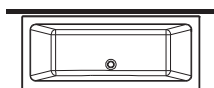

left
gauche

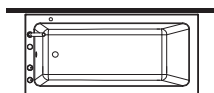

right
droite

Water volume 351 l.
Volume d'eau 351 l.



⁽¹⁾ Bath waste not included
Vidage non inclus

⁽²⁾ Waste included
Vidage inclus

⁽³⁾ Bath waste and overflow set included
with filler

Vidage automatique avec bec verseur

⁽⁴⁾ Make sure that all the important
equipment and LED lights can be easily
accessed

Ne doit pas être encastrée sans
possibilité d'accéder aux spots

		FINISH FINITION	BRASSWARE ROBINETTERIE	SAP	KEA	€	
BASIC			(1)_	100050938	N710000114	724,00 €	
		(3)		100050939	N710000115	1.725,00 €	
BATH WITH FRAME CHASSIS SANS HYDROMAS- SAGE			(1)_	100050940	N710000102	1.265,00 €	
		(3)		100050941	N710000126	2.236,00 €	
S0			(1)_	100050942	N710000129	2.402,00 €	
		right droite	(3)		100050943	N710000139	3.432,00 €
		left gauche	(3)		100050952	N710000089	3.432,00 €
			(2)_	100102555	N710000631	3.042,00 €	
SX1		right droite	(3)		100102556	N710000784	4.117,00 €
		left gauche	(3)		100102557	N710000823	4.117,00 €
SX2			(2)_	100102558	N710000641	3.667,00 €	
		right droite	(3)		100102559	N710000844	4.514,00 €
		left gauche	(3)		100102560	N710000735	4.514,00 €
			(2)_	100102561	N710000713	4.686,00 €	
SX3		right droite	(3)		100102562	N710000709	5.761,00 €
		left gauche	(3)		100102563	N710000682	5.761,00 €
SX4 ⁽⁴⁾			(2)_	100102564	N710000817	7.344,00 €	
		right droite	(3)		100102565	N710000779	8.420,00 €
		left gauche	(3)		100102566	N710000785	8.420,00 €
			(2)_	100102567	N710000783	5.402,00 €	
SX5 ⁽⁴⁾		right droite	(3)		100102568	N710000769	6.248,00 €
		left gauche	(3)		100102569	N710000661	6.248,00 €

ACCESSORIES • ACCESSOIRES

	DESCRIPTION DESCRIPTION	COLOUR COULEUR	SAP	KEA	€	BASIC	FRAME CHASSIS	S0	SX1	SX2	SX3	SX4	SX5
	⁽¹⁾ Bath waste and overflow set NEXT + Syphon • Vidage automatique NEXT + Syphon		100060498	N780000002	51,00 €	✓	✓	✓					
	⁽¹⁾ NEXT bath filler waste and overflow set including bath trap • Vidage NEXT avec bec verseur + Syphon		100060521	N780000008	130,00 €	✓	✓	✓					
	COLD head rest • Appui-tête COLD		100066186	N770000052	91,00 €	✓	✓	✓	✓	✓	✓	✓	✓
	ENJOY head rest • Appui-tête ENJOY		100056383	N770000007	239,00 €								
			100056384	N770000034	239,00 €	✓	✓	✓	✓	✓	✓	✓	✓
			100056387	N770000017	239,00 €								
	ENJOY "S" head rest • Appui-tête ENJOY "S"		100060780	N770000049	198,00 €								
			100060753	N770000065	198,00 €	✓	✓	✓	✓	✓	✓	✓	✓
			100060767	N770000057	198,00 €								
	⁽²⁾ Set of CASUAL PLUS support frame with feet • Kit châssis universel CASUAL PLUS		100060499	N770000066	49,00 €	✓							
	⁽³⁾ Bath access panel • Trappe de visite baignoire		250021559	N790001316	331,00 €	✓	✓	✓	✓	✓	✓	✓	✓
	MODUL panel 190 • 190 Tablier MODUL		100056223	N770000159	232,00 €		✓	✓	✓	✓	✓	✓	✓
	MODUL panel 90 • 90 tablier MODUL		100056220	N770000147	111,00 €		✓	✓	✓	✓	✓	✓	✓
	CLUB panel 190 • 190 Tablier CLUB		100056102	N770000141	371,00 €								
			100056104	N770000127	402,00 €		✓	✓	✓	✓	✓	✓	✓
			100056103	N770000131	434,00 €								
	CLUB panel 90 • 90 Tablier CLUB		100056084	N770000115	194,00 €								
			100056086	N770000137	208,00 €		✓	✓	✓	✓	✓	✓	✓
			100056085	N770000119	224,00 €								

⁽¹⁾ Only required for the models not including brassware • Nécessaire uniquement pour les modèles sans robinetterie

⁽²⁾ Recommended use of 2 sets • On recommande 2 jeux pour ce modèle

⁽³⁾ Required for all built-in installations • Nécessaire pour tous les modèles encastrés