

by SIMONE MICHELI

brassware / robinetterie LOUNGE

1

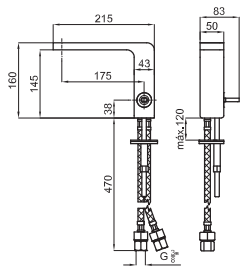

2

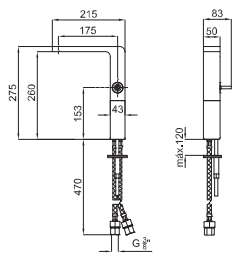

- 1** Single lever basin mixer with 3/8" connections. Ø25 mm ceramic cartridge. Length of hoses 470 mm. without pop-up waste. Spout with flow-breaker (limit flow rate at 8 l/min. at 3 bar to avoid splashing water).  
*Mitigeur lavabo avec cartouche Ø25mm. flexibles raccords 3/8". Longueur 470 mm., sans vidage. Bec avec brise-jet laminaire et limiteur de débit à 8 l/min. pour éviter les éclaboussures.*



100156373  
N199999359

Chrome  
Chromé



590,00 €

100073047  
N199999897

White  
Blanc



719,00 €

- 2** High spout single lever basin mixer with 3/8" connections. Ø25 mm ceramic cartridge. Length of hoses 470 mm. Without pop-up waste. Spout with flow-breaker (limit flow rate at 8 l/min. at 3 bar to avoid splashing water).  
*Mitigeur lavabo bec haut avec cartouche Ø25 mm. Flexibles raccords 3/8". Longueur 470 mm., sans vidage. Bec avec brise-jet laminaire et limiteur de débit à 8 l/min. pour éviter les éclaboussures.*



100156374  
N199999360

Chrome  
Chromé



758,00 €

100073041  
N199999900

White  
Blanc



913,00 €

# LOUNGE

brassware - robinetterie

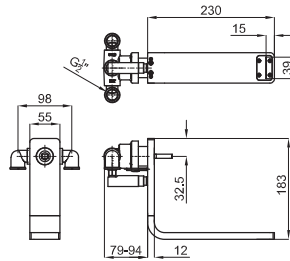

Wall mounted basin mixer with 1/2" connections. Ø25 mm ceramic cartridge. Without pop-up waste. Spout with flow-breaker. Flow rate (mixed water) 9,92 l/min. at 3 bar.  
 Mitigeur lavabo à encastrer avec cartouche Ø25 mm. Raccordement 1/2". Sans vidage. Bec avec brise-jet laminaire. À 3 bars de pression (eau mélangée) 9,92 l/min.



100063522 N199999990		Chrome Chromé		783,00 €
100073039 N199999894		White Blanc		913,00 €

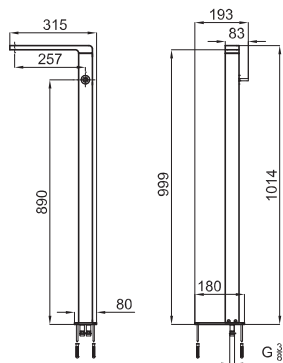

Floor mounted basin mixer with 3/8" connections. Spout with flow-breaker. Flow rate (mixed water) 12,23 l/min. at 3 bar.  
 Mitigeur lavabo installation au sol avec cartouche Ø35 mm. Raccordements 3/8". Bec avec brise-jet laminaire. Chute d'eau en effet cascade. À 3 bars de pression (eau mélangée) 12,23 l/min.



100063517 N199999986		Chrome Chromé		1.746,00 €
100073040 N199999902		White Blanc		2.026,00 €

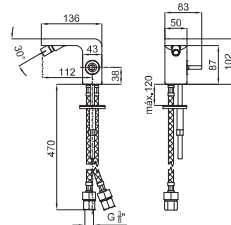

Single lever bidet mixer with 3/8" connections. Ø25 mm ceramic cartridge. Length of hoses 470 mm. Without pop-up waste. Flow rate (mixed water) 7,6 l/min. at 3 bar.  
 Mitigeur bidet avec cartouche Ø25 mm. Flexibles raccordement 3/8" longueur 470 mm. Sans vidage. À 3 bars de pression (eau mélangée) 7,6 l/min.



100063519 N199999980		Chrome Chromé		590,00 €
100073042 N199999899		White Blanc		719,00 €

1

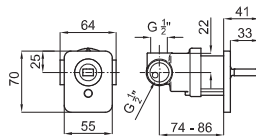

2

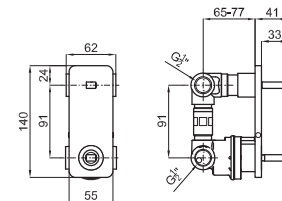

1 Concealed shower mixer 1/2". Flow rate (mixed water) 18,57 l/min. at 3 bar.  
 Mitigeur douche à encastrer. Raccordements 1/2". À 3 bars de pression (eau mélangée) 18,57 l/min.



100063521 N199999981		Chrome Chromé		446,00 €
100073044 N199999895		White Blanc		524,00 €

2 Concealed bath/shower mixer 1/2". Automatic diverter. Flow rate (mixed water) 16,58 l/min. at 3 bar.  
 Mitigeur bain/douche à encastrer. Raccordements 1/2". Inverseur automatique. À 3 bars de pression (eau mélangée) 16,58 l/min.



100063520 N199999899		Chrome Chromé		685,00 €
100073043 N199999893		White Blanc		797,00 €

# LOUNGE

brassware - robinetterie

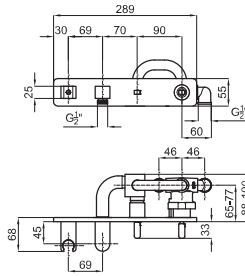

Concealed bath/shower mixer 1/2" + wall handshower holder + shower wall bracket. Automatic diverter. Flow rate (mixed water) 16,26 l/min. at 3 bar.  
 Mitigeur bain/douche à encastrer avec support, prise d'eau et inverseur (flexible et douchette n'est pas inclus). Raccordements 1/2". À 3 bars de pression (eau mélangée) 16,26 l/min.



100063516  
N19999984

Chrome  
Chromé



1.109,00 €

100073036  
N199999892

White  
Blanc



1.297,00 €

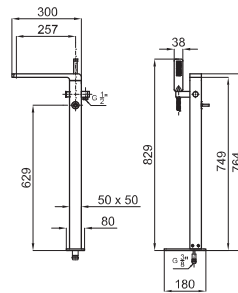

Floor mounted bath shower mixer 1/2". Spout with flow-breaker, automatic diverter. Flow rate (mixed water) 14,83 l/min. at 3 bar for spout and 14,12 l/min. at 3 bar for handshower.  
 Mitigeur bain/douche installation au sol avec cartouche Ø35 mm. Raccordement 1/2". Douchette, flexible et support inclus. Inverseur automatique. Bec avec brise-jet laminaire. Chute d'eau en effet cascade. À 3 bars de pression (eau mélangée) 14,83 l/min. pour bec et 14,12 l/min. pour douchette.



100063518  
N19999982

Chrome  
Chromé



2.320,00 €

100073038  
N199999896

White  
Blanc



2.623,00 €

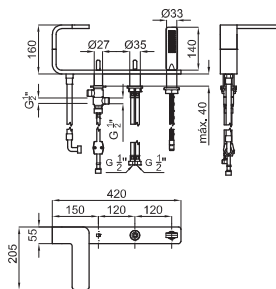

4 hole deckmounted bath set 1/2". Consisting of: handle, bath spout, diverter and hand shower with flexi shower 150 cm. Spout with flow-breaker. Flow rate (mixed water) 13,64 l/min. at 3 bar for spout and 13,76 l/min. at 3 bar for handshower.  
 Mitigeur bain/douche 4 pièces à poser sur baignoire. Commande, inverseur, douchette et flexible 150 cm. inclus. Flexibles raccords 1/2". Bec avec brise-jet laminaire. Chute d'eau en effet cascade. À 3 bars de pression (eau mélangée) 13,64 l/min. pour bec et 13,76 l/min. pour douchette.



100063511  
N199999991

Chrome  
Chromé



1.929,00 €

100073045  
N199999898

White  
Blanc



2.226,00 €

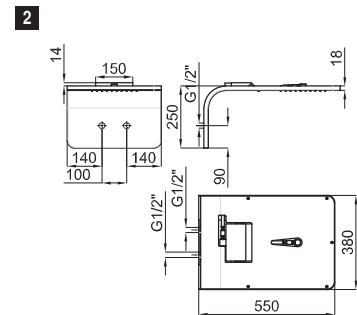
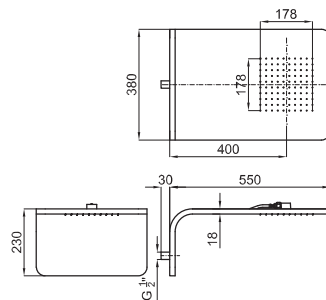

1 Rain function shower head with 1/2". Flow rate (mixed water) 10,75 l/min. at 3 bar.  
 Pomme de douche fonction pluie. À 3 bars de pression (eau mélangée) 10,75 l/min.



100063526  
N199999888

Chrome  
Chromé



1.882,00 €

100082392  
N199999861

White  
Blanc



2.626,00 €

2 Rain+cascade shower head with 1/2" connectors. Flow rate (mixed water) 16,80 l/min. at 3 bar. Rain shower function 10,8 l/min and cascade 11,40 l/min.  
 Pomme de douche fonction pluie + cascade avec raccords de 1/2". À 3 bars de pression (eau mélangée) fonction pluie 10,8 l/min et fonction cascade 11,4 l/min.



100089933  
N199999811

Chrome  
Chromé



2.129,00 €

1

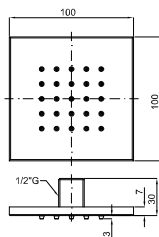

2

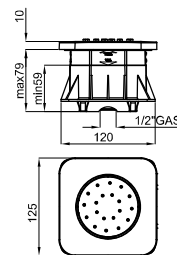

**1** Wall mounted body jet 1/2". Minimum flow rate required: 4 l/min. at 3 bar  
*Buse latérale douche 1/2". Requiert un débit minimum à 3 bars de 4 l/min.*



100065936  
N140140023

● Chrome  
● Chromé



143,00 €

100137901  
N140140072

○ White  
○ Blanc



176,00 €

**2** 1/2" concealed body jet. Minimum flow rate required: 3,55 l/min. at 3 bar  
*Buse latérale douche 1/2". Requiert un débit minimum à 3 bars de 3,55 l/min.*



100093549  
N19999773

● Chrome  
● Chromé



159,00 €

1

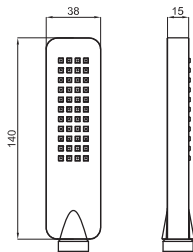

2

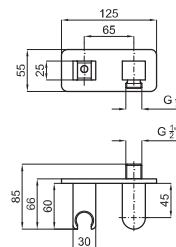

**1** Single function handshower  
*Douchette 1 jet*



100065250  
N29999838

● Chrome  
● Chromé



178,00 €

100084981  
N29999656

○ White  
○ Blanc



250,00 €

**2** Wall handshower holder with shower outlet elbow 1/2"  
*Support mural fixe avec prise d'eau. Raccordement 1/2"*



100063527  
N19999985

● Chrome  
● Chromé



328,00 €

100073046  
N19999891

○ White  
○ Blanc



386,00 €