

residence
kitchen technical catalogue 2017



BY APPOINTMENT TO
H.R.H. THE PRINCE OF WALES
MANUFACTURER AND DISTRIBUTOR
OF CERAMIC TILES AND BUILDING PRODUCTS.
PORCELANOSA GROUP LIMITED

PORCELANOSA Grupo

The power of a trademark

The power of a trademark. PORCELANOSA Grupo is today a major reference on both the Spanish and international markets. Its consolidated position has been built up on values such as innovation and quality, but especially the trust placed in its large human capital, made up of almost 5,000 skilled professionals, and its concern for its stakeholders and environment. PORCELANOSA Grupo has almost 40 years' experience and is present in almost 100 countries worldwide. This success is the result of a unique business model based on a strong corporate strategy. Today, the Group's eight companies offer a vast selection of products ranging from kitchen and bathroom equipment to state-of-the-art building solutions for contemporary architecture.

El poder de una marca. PORCELANOSA Grupo es hoy una compañía de referencia en el mercado nacional e internacional, asentada sobre valores como la innovación y la calidad pero, sobre todo, basada en la confianza depositada en su extenso equipo humano, formado por casi 5.000 personas, y en la atención a su entorno social. Con casi 40 años de experiencia, PORCELANOSA Grupo está presente en cerca de 100 países alrededor del mundo, gracias a un modelo de negocio irrepetible, sobre el que se apoya una fuerte estrategia empresarial. En la actualidad, las ocho empresas del Grupo ofrecen una extensa gama de productos que incluyen desde equipamiento para cocina o baño hasta avanzadas soluciones constructivas para la arquitectura contemporánea.

Le pouvoir d'une marque. PORCELANOSA Grupo est aujourd'hui une société de référence sur le marché espagnol et international, elle est régie par des valeurs telles que l'innovation et la qualité mais, avant tout, elle travaille dans un climat de confiance totale dans sa grande équipe de professionnels, composée de près de 5.000 personnes, et porte un grand intérêt à son environnement social. Forte de près de 40 années d'expérience, la société PORCELANOSA Grupo est présente dans près de 100 pays du monde entier, grâce à un modèle d'affaire inimitable, sur lequel repose une stratégie industrielle efficace. Les huit entreprises du Groupe proposent aujourd'hui une vaste gamme de produits qui s'étend des équipements pour la cuisine ou la salle de bains à des solutions de construction ultramodernes pour l'architecture contemporaine.

Our philosophy

Our philosophy. GAMADecOR was founded in 1987 to produce top quality bathroom and kitchen furniture based on concepts of advanced design and technology. Based in Villarreal (Castellón), the company's facilities, which exceed 125,000 m², are equipped with the very latest technology. We currently export to over fifty countries on all five continents and have our own showrooms in Spain, France, the UK, USA, Mexico, Italy and Portugal.

Nuestra filosofía. GAMADecOR nace en el año 1987 con el objetivo de ofrecer productos de alta calidad, tecnología y diseño avanzado en la fabricación de muebles de baño y cocina. Ubicada en Villarreal (Castellón), sus instalaciones están dotadas de los últimos avances técnicos, ocupando en la actualidad una superficie superior a los 125.000 m², actualmente exportamos nuestros productos a más de cincuenta países de los cinco continentes, con tiendas propias en España, Francia, Reino Unido, Estados Unidos, México, Italia y Portugal.

Notre philosophie. GAMADecOR est une société créée en 1987 avec l'intention d'offrir des produits de haute qualité et incorporant des technologies de pointe et des designs ultramodernes dans la production de meubles de salles de bains et de cuisines. Situées à Villarreal (Castellón, Espagne), ses installations mettent à profit les derniers progrès techniques et occupent actuellement une surface de plus de 125.000 m². Nos produits sont exportés dans plus de cinquante pays des cinq continents et nous disposons de nos propres points de vente en Espagne, en France, au Royaume Uni, aux États Unis, au Mexique, en Italie et au Portugal.

Ecological commitment



The mark of responsible forestry
FSC® C115389



In keeping with Gamadecor's demonstrated commitment to the environment, an Environmental Management System has been introduced by the company and certified as complying with the ISO 14001:2004 international standard. This system ensures the identification of all environmental impacts and aspects of Gamadecor's activities and improvements to its environmental performance, as well as contributing toward environmental protection and the prevention of pollution, from a balanced perspective that takes into account socioeconomic factors. At the same time, a Chain of Custody control system for wood has been introduced so as to ensure that the raw materials used to manufacture the company's products are sourced from controlled forests. In this way, Gamadecor can offer products with full environmental guarantees.

Siguiendo con la sensibilidad que Gamadecor siempre ha demostrado por el Medio Ambiente, se ha implantado y certificado el Sistema de Gestión Medioambiental basado en la norma internacional ISO 14001:2004. Dicho sistema permite localizar y mejorar todos los aspectos e impactos medioambientales que provocan todas las actividades de Gamadecor, además de promover la protección ambiental y la prevención de la contaminación, desde un punto de vista de equilibrio con los aspectos socioeconómicos. En paralelo, se ha implantado un sistema de Control de la Cadena de Custodia de la madera, con el fin de que las materias primas utilizadas en la fabricación de nuestros productos tengan su origen en bosques controlados. De esta forma Gamadecor puede ofrecer productos 100% respetuosos con el medio ambiente.

Fidèle à la sensibilité dont Gamadecor a toujours fait preuve en ce qui concerne l'environnement, la société a implanté et certifié un Système de Gestion Environnementale fondé sur la norme internationale ISO 14001:2004. Ce système a pour objet d'identifier et d'améliorer tous les aspects et impacts affectant l'environnement et résultant de toutes les activités de Gamadecor, ainsi que de promouvoir la protection de l'environnement et la prévention de la pollution, dans une perspective d'équilibre avec les aspects socioéconomiques. Parallèlement, l'entreprise a implanté un système de contrôle de la Chaîne de Conservation du bois visant à garantir que les matières premières employées dans la fabrication de nos produits proviennent de forêts contrôlées. De cette manière Gamadecor est en mesure de proposer des produits à 100 % respectueux avec l'environnement.

Maximum quality



Maximum quality. GAMADDECOR works consistently to implement quality systems within the organisation. The success of these efforts is reflected in effective management and the steady increase in the standards of the products and services we offer our customers. Obtaining ISO Certificates and integrating an information and management system based on work flows is the first step in establishing quality controls. This quality control system also allows for the optimum integration of the various management systems in the areas of quality, the environment and health and safety.

Calidad máxima. GAMADDECOR realiza una labor continua en la implantación de la calidad dentro de la organización. Esta labor se refleja en una gestión ágil y un incremento constante en la calidad de productos y servicios a los clientes. La consecución de los certificados ISO y la integración de un sistema de información y gestión basado en flujos de trabajo, es el primer paso para establecer los controles de calidad. Este sistema de control de calidad nos permite además la integración óptima de los diferentes sistemas de gestión (calidad, medio ambiente y seguridad e higiene).

La meilleure qualité. GAMADDECOR travaille continuellement à l'implantation de normes de qualité au sein de l'organisation. Ces efforts se reflètent dans une gestion efficace et une augmentation constante de la qualité des produits et des services proposés aux clients. L'obtention des certificats ISO et l'intégration d'un système d'information et de gestion fondé sur les flux de travail constituent le premier pas à franchir pour pouvoir établir des contrôles de qualité. Ce système de contrôle de la qualité nous permet par ailleurs d'intégrer de façon optimale les différents systèmes de gestion (qualité, environnement, sécurité et hygiène).

More than 400 showrooms worldwide

More than 400 showrooms worldwide. With more than 400 showrooms worldwide and a constantly expanding distribution network that reaches cities such as Miami, Paris or Milan, the PORCELANOSA showrooms guarantee the firm's presence on all five continents, providing final consumers with the chance to obtain a first-hand insight into the ongoing innovations and latest designs of each of its products.

Más de 400 tiendas en el mundo. Con más de 400 establecimientos repartidos por todo el mundo y una red de distribución que sigue ampliándose día a día en ciudades como Miami, París o Milán, las tiendas PORCELANOSA aseguran la presencia de esta firma en los cinco continentes para mostrar al consumidor final el continuo avance en innovación y diseño de cada uno de sus productos.

Plus de 400 points de vente dans le monde entier. Avec plus de 400 établissements distribués dans le monde entier et un réseau de distribution qui ne cesse de se développer de jour en jour dans des villes telles que Miami, Paris ou Milan, les points de vente de PORCELANOSA assurent la présence de cette firme sur les cinq continents pour faire découvrir au consommateur final les progrès que le Groupe réalise continuellement en matière d'innovation et de design de toute sa production.



00

content contenido contenu

- C.01 / p.10 introduction
introducción
introduction
- C.02 / p.36 models, finishes, handles
modelos, acabados, tiradores
modèles, finitions, poignées
- C.03 / p.46 base units
módulos bajos
modules bas
- C.04 / p.88 tower units
columnas
colonnes
- C.05 / p.178 wall units
módulos altos
modules hauts
- C.06 / p.250 equipment for base, wall and tower units
equipamiento para módulos bajos, altos y columnas
équipement pour modules bas, hauts et colonnes
- C.07 / p.266 plinths
zócalos
plinthes
- C.08 / p.270 decorative panels and custom sizes
material de revestimiento y confecciones especiales
matériau de revêtement et confections spéciales
- C.09 / p.278 replacement and miscellaneous items
repuestos y elementos sueltos
pièces de rechange et éléments isolés





01 introduction introducción introduction

- p.12** Qualities, manufacture and explanation
Calidades, elaboración y argumentación
Qualités, élaboration et argumentation
- p.13** Unit features
Características del módulo
Caractéristiques du module
- p.14** Technical height and depth design
Esquema técnico de alturas y profundidades
Schéma technique de hauteur et profondeur
- p.16** Basic modulation schemes
Esquemas de modulación básica
Schémas de modulation basic
- p.17** Modulation schemes for integrated handle
Esquemas de modulación para tirador integrado
Schémas de modulation pour poignée intégrée
- p.18** Modulation schemes for 60° mitered-mechanized handle
Esquemas de modulación para tirador mecanizado a 60°
Schémas de modulation pour poignée usiné coupe en 60°
- p.19** Features of kitchens with 60° mitered-mechanized handle
Características de cocinas con tirador mecanizado a 60°
Caractéristiques des cuisines avec poignée usiné coupe en 60°
- p.22** Tower units for oven and microwave
Columnas para horno y microondas
Colonnes pour four et micro-ondes
- p.23** Tower units for fridge
Columnas para frigorífico
Colonnes pour réfrigérateur
- p.24** Design aids for electricity and plumbing installation
Ayudas de proyección para instalaciones eléctricas y de fontanería
Assistant de projection pour installations électriques et plomberie
- p.26** Warranty
Garantía
Garantie
- p.28** Recommendations for use and maintenance
Recomendaciones de uso y mantenimiento
Conseils pour l'usage et son entretien
- p.32** General conditions of sale
Condiciones generales de venta
Conditions générales de vente
- p.34** Icon glossary
Glosario de iconos
Glossaire des icônes
- p.35** What does the model number indicate?
¿Qué indica el número de modelo?
Qu'est-ce que le numéro de modèle indique?

Specifications, assembly process & sales arguments

- 16mm-thick water-resistant particleboard carcass, laminated with a decorative overlay in a smooth Niebla or Zinc finish. These particleboards are certified with the FSC® forest stewardship label and CARB2 label (the lowest formaldehyde emissions).
- All the edges of the carcasses and shelves are faced with 1mm-thick ABS edging tape, bonded with PUR adhesive with an extra high resistance to impacts and high temperatures.
- Back panel made of 8mm particleboard (in the same finish as the carcass), inserted into the vertical and horizontal grooves of the carcass and glued in place.
- The different sections of the carcass are assembled using hard wood dowel pins and glued at the same time as the back panel, using different presses. This guarantees full stability.
- The hinges are 100% metal, adjustable in 3 dimensions. They have an opening angle that ranges from 110° to 165°, depending on the type of unit, and a soft-close system. Thanks to the hinges' clip mechanism, the doors can easily be mounted or removed without tools.
- The legs of the unit are made of solid compact material for extra rigidity and resistance. The bases of the legs are mounted in such a way that the weight of the units and countertops (particularly granite ones) is evenly distributed between the sides and the base, thus preventing the units from gradually collapsing. The legs can be adjusted from -15 to +25 mm.
- The shelf supports are made of resistant material and include an anti-tip mechanism. The height of the shelves can be adjusted using the holes in the side panels.
- The drawers and deep drawers, with their cutting-edge design, are dark grey coloured. They are equipped with full-extension Nova Pro Scala drawer system from Grass, so that the front panel can be taken off without tools and adjusted 3 dimensionally. All the drawers and deep drawers feature a soft-close mechanism. A wide range of optional accessories and organizers made of wood or plastic are available for use inside the drawers and deep drawers.
- Concealed behind the back panel, the fastening system of the wall units is designed to distribute the weight between the top and sides. The units can be adjusted from the inside.
- The doors can be: 19mm-thick laminated or HPL finish doors with ABS edging tape or laser edging.
- The soft-formed edges have been machined to the required shape and then wrapped with a single-layer edging band, using high-resistance PUR adhesive.
- With laser edging, a more long-lasting bond is ensured, the joints are almost invisible, and because no glues or cleaning solvents are used, the environmental impact is much lower.

Calidades, Elaboración y Argumentación

- Material de estructura con base tablero aglomerado hidrófugo, 16 mm de grosor, con revestimiento de laminado decorativo, acabado de estructura fina en color Niebla o Zinc. Este tablero está certificado como FSC® y CARB2 (muy baja emisión de formaldehído).
- Todos los cantos de las estructuras y de las baldas están recubiertos con un canto de ABS de 1.0 mm de grosor encolado con cola PUR especialmente resistente a los impactos y a las altas temperaturas.
- Trasera con base tablero aglomerado de 8 mm. (con el mismo acabado que la estructura) insertado y encolado en ranuras verticales y horizontales.
- El ensamblaje de las piezas estructurales se realiza con mechones de madera dura y, mediante diferentes prensas, son encoladas al mismo tiempo que la trasera. Este sistema aporta una estabilidad absoluta al módulo.
- Las bisagras empleadas son totalmente metálicas, regulables tridimensionalmente, su ángulo de apertura varía entre 110° y 165°, dependiendo del tipo de módulo e incorporan ralentizador por cierre. El sistema "clip" facilita el montaje y desmontaje de las puertas sin herramientas.
- Las patas del módulo son de un material sólido y compacto para aportar mayor rigidez y resistencia. Los soportes de las patas están montados de tal forma, que el peso de los módulos y encimeras (especialmente de granito) se reparte entre la estructura lateral y la base, esto evita el hundimiento paulatino del módulo. Las patas son regulables entre -15 y + 25 mm.
- Los soporta-estantes son de un material resistente con sistema anti-vuelco. Existe la posibilidad de regular las baldas, a través de las perforaciones laterales.
- Los cajones y gavetas, de color gris oscuro, son de última generación. Equipan guías Nova Pro Scala de Grass, de extracción total, que permiten desmontar el frente sin herramientas y ajustarlo tridimensionalmente. El sistema "ralentizador de cierre" está incluido en todos los cajones y gavetas. Opcionalmente podemos equipar el interior de los cajones y gavetas con una amplia gama de accesorios y organizadores en madera o polímero.
- La sujeción de los muebles altos esta oculta detrás de la trasera, con reparto del peso entre el techo y los laterales. La regulación se efectúa desde el interior del módulo.
- Las puertas son de varios tipos: laminado o estratificado de 19 mm de grosor, el canteado puede ser mediante cola PUR o tecnología láser, en función del modelo.
- Para modelos con tiradores integados, se emplea la tecnología del canteado con forma "softforming", que consiste en mecanizar los bordes con la forma deseada para, en un proceso posterior, moldear una única lámina de canto y pegarla con cola PUR de alta resistencia alrededor del borde.
- Con el canteado laser se obtiene una unión más duradera, las juntas son casi invisibles y gracias a la no utilización de colas y disolventes de limpieza el impacto medioambiental es mucho menor.

Qualités, Élaboration et Argumentation

- Matériau de structure avec un panneau de base en aggloméré hydrofuge, 16 mm d'épaisseur, à revêtement laminé décoratif, finition lisse en couleurs Niebla ou Zinc. Ces panneaux portant le label FSC® de chaîne de traçabilité et le label CARB2 (Les plus faibles émissions de formaldéhyde).
- Tous les chants des structures et des étagères sont recouverts d'un chant en ABS de 1,0 mm d'épaisseur encollé avec de la colle PUR tout particulièrement résistante aux impacts et aux températures élevées.
- Fond correspondant à un panneau laminé de 8 mm. (avec la même finition que la structure) inséré et encollé au sein de rainures verticales et horizontales.
- L'assemblage des pièces de structure est réalisé à l'aide de tourillons en bois dur, et elles sont encollées à l'aide de différentes presses en même temps que le panneau arrière. Ce système apporte une stabilité absolue au module.
- Les charnières utilisées sont entièrement métalliques, à réglage tridimensionnel, leur angle d'ouverture varie entre 110° et 165°, selon le type de module et elles incorporent un système de fermeture en douceur. Le système « clip » permet le montage et le démontage des portes sans outils.
- Le matériau des pieds du module est solide et compact pour donner plus de rigidité et de résistance à l'ensemble. Les supports des pieds sont montés de telle sorte que le poids des modules et des plans de travail (notamment en granit) est distribué entre la structure latérale et la base, cela évite l'affaissement progressif du module. Les pieds peuvent être réglés entre -15 et + 25 mm.
- Les pièces de support d'étagères sont fabriquées en un matériau résistant incluant un système anti-renversement. Il existe la possibilité de régler les étagères à travers les perforations latérales.
- Les tiroirs et tiroirs hauts, de couleur gris foncé sont de dernière génération. Ils sont équipés de guides Nova Pro Scala de Grass à extraction totale qui permettent de démonter le panneau avant sans outils et de l'ajuster de façon tridimensionnelle. Le système de « fermeture en douceur » est inclus dans tous les tiroirs et tiroirs hauts. En option, nous pouvons équiper l'intérieur des tiroirs et tiroirs haut avec une large gamme d'accessoires et de séparateurs en bois ou plastique.
- La fixation des éléments muraux est cachée derrière le panneau arrière, avec distribution du poids entre la partie supérieure et les côtés. Le réglage est effectué depuis l'intérieur du module.
- Les portes sont de plusieurs types : laminé ou stratifié de 19 mm d'épaisseur avec un chant en ABS encollé avec de la colle PUR ou chant en PP assemblé avec technologie laser.
- Le placage de chants de forme « softforming » consiste à mécaniser les bords avec la forme souhaitée, afin de pouvoir, lors d'un processus ultérieur, mouler une unique plaque de chant et la coller à l'aider de colle PUR haute résistance autour du bord.
- Le placage de chant laser permet d'obtenir une union plus durable, les joints sont quasiment invisibles et comme il n'utilise ni colle ni dissolvant, l'impact sur l'environnement est bien moindre.

Unit components
Componentes de módulo
Composants de module

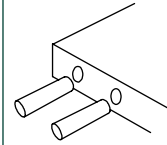
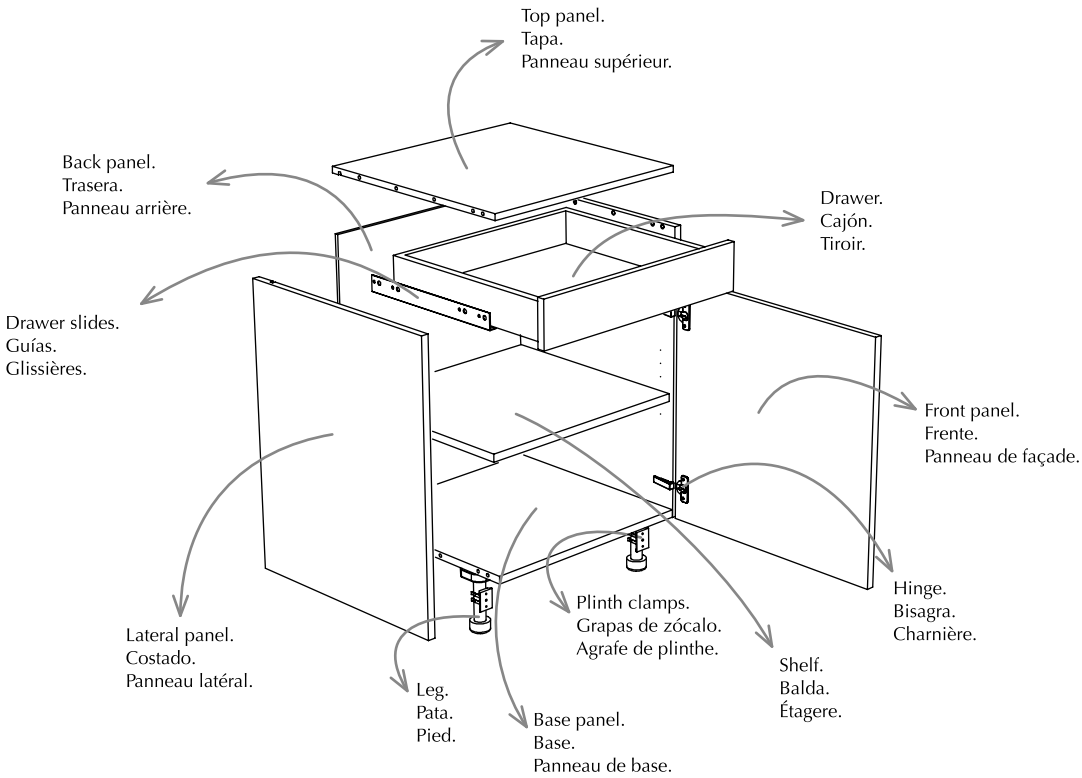

Assembling with dowels.
 Ensamblaje mediante mechones.
 Pièces assemblées au moyen de tenons.

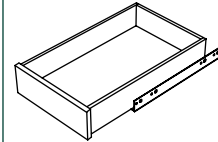

Totally removable standard and deep drawers.
 Cajones y gavetas extracción total.
 Tiroirs et bacs à sortie totale.

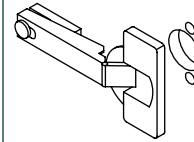

Adjustable metal hinges.
 Bisagras metálicas y regulables.
 Charnières métalliques et réglables.

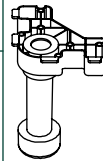

Resistant legs and leg stands.
 Soportes y patas resistentes.
 Supports et pieds résistants.

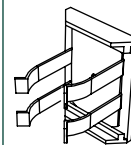

Plinth clamps easily removable.
 Grapas de zócalo de fácil extracción.
 Agrafe de plinthe facile à extraire.

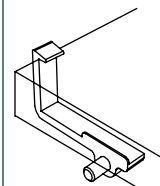

Shelf holder anti-tilt
 Soporta-estante anti-vuelco
 Support d'étagère anti-basculement

Interior finishes
Acabados de interior
Finitions intérieurs

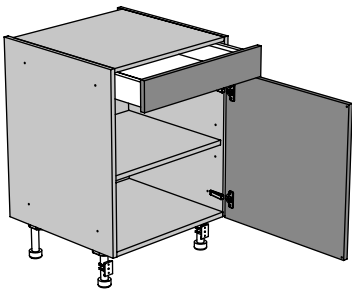

- Chosen finish.**
 Handles and finishes options depending on the kitchen model.
Acabado seleccionado.
 Opciones de acabados y tiradores en función del modelo de cocina.
Finition choisie.
 Options de finitions et poignées selon le modèle de cuisine.
- Carcass colour.**
 Interior finish options depending on kitchen series.
Color de casco.
 Opciones de acabado interior en función de la serie de cocina.
Couleur de caisson.
 Options de finitions intérieurs selon la série de cuisine.

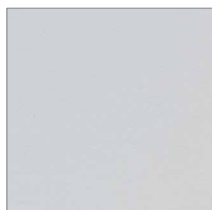

Niebla



Zinc

Base and wall units / Módulos bajos y altos / Modules bas et hauts

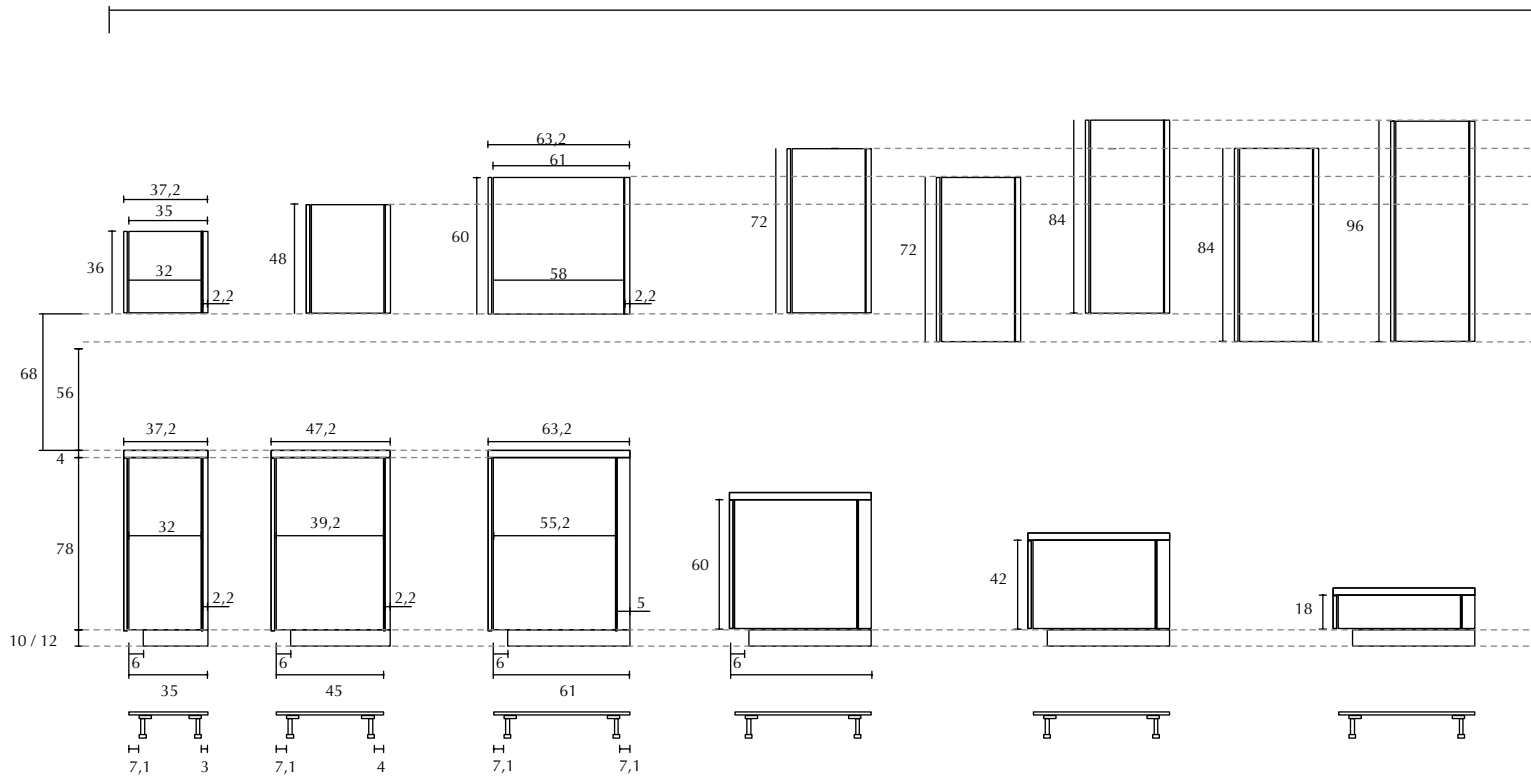

*Measures shown in centimetres
 *Medidas presentadas en centímetros
 *Dimensions en centimètres

Total Height / Altura total / Hauteur totale

Plinth height Altura de zócalo Hauteur de plinth	Base unit height with 4 cm worktop thick. Altura de módulo bajo con 4 cm de espesor de encimera. Hauteur de module bas avec 4 cm d'épaisseur de plan de travail.		Total height depends on tower unit height Altura total según altura columnas Hauteur totale selon hauteur colonnes				
	60 + 4	78 + 4	150	198	210	222	234
10	74	92	160	208	220	232	244
12	76	94	162	210	222	234	246

Tower units / Módulos columna / Modules colonne

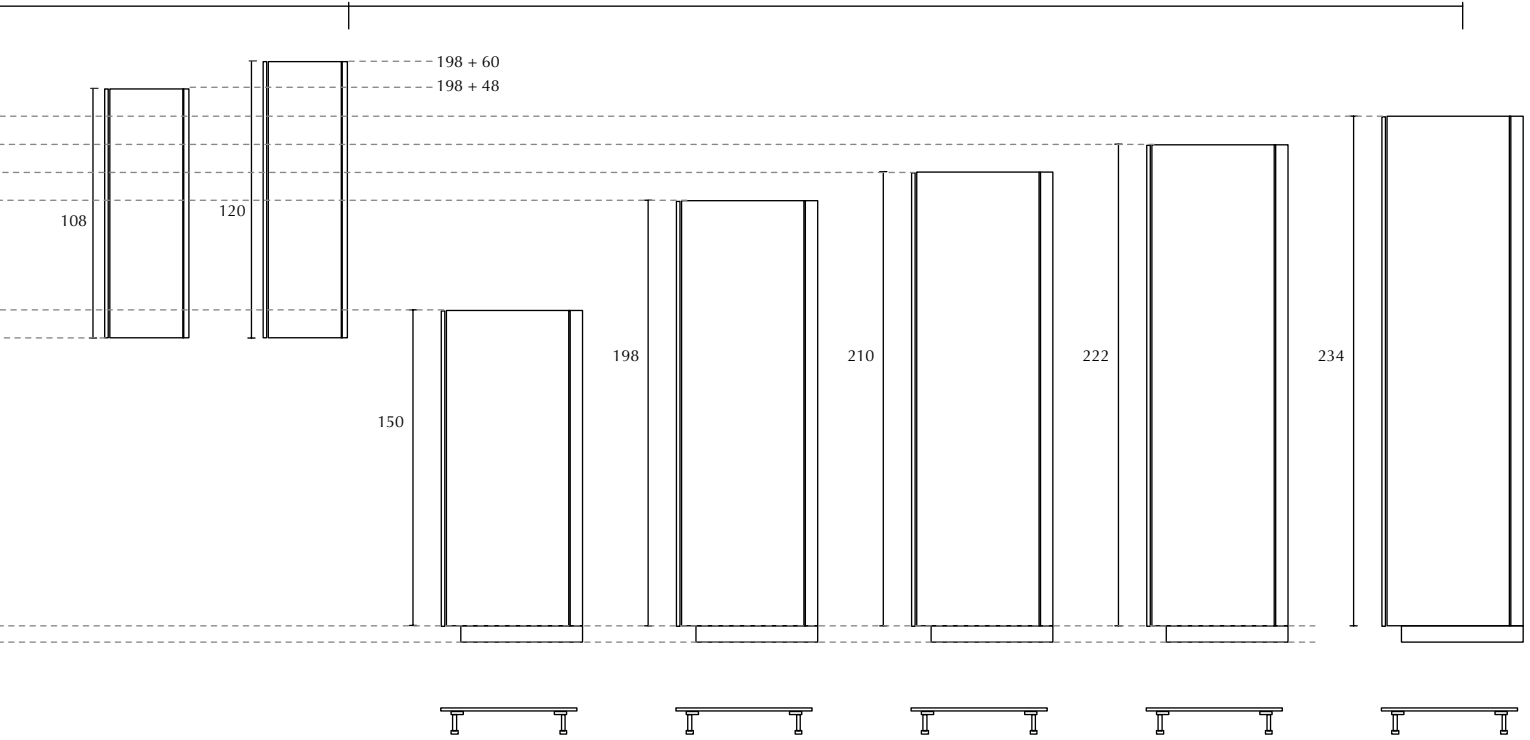

Total Depth / Profundidad total / Profondeur totale

Front door thick with 3 mm of free gap. Espesor de frente con 3 mm de espacio libre. Épaisseur de façade avec 3 mm d'écart libre.	Base unit total depth. Profundidad total de módulo bajo. Profondeur totale de module bas.			Wall unit total depth. Profundidad total de módulo alto. Profondeur totale de module haut.		Tower unit total depth. Profundidad total de módulo columna. Profondeur totale de module colonne.		
	35	45	61	35	61	35	45	61
1,9 + 0,3	37,2	47,2	63,2	37,2	63,2	37,2	47,2	63,2

Base units.

Módulos bajos.

Modules bas.

H: 18 / 42 / 60 / 78 cm. Wall hung base units and base units / Bajos suspendidos y a tierra / Module bas et module bas suspendu

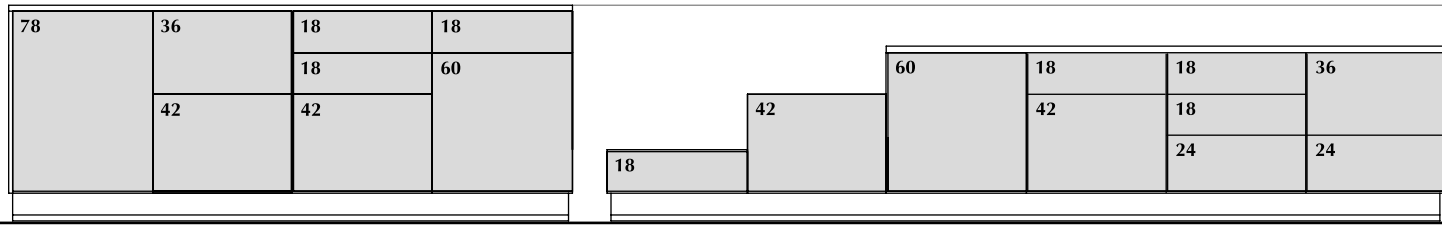

Tower units.

Módulos columna.

Modules colonne.

H: 150 / 198 / 210 / 222 / 234 cm.

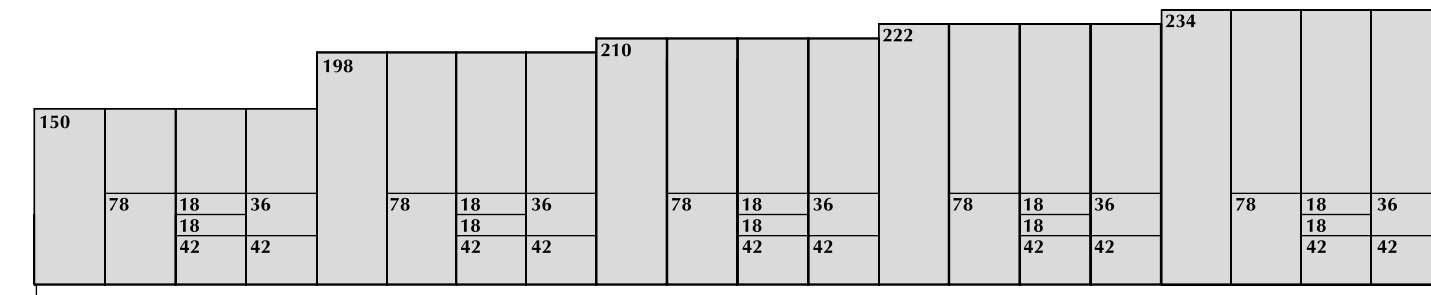

Tower units for oven and microwave.

Columna para horno y microondas.

Colonne pour four et micro-ondes.

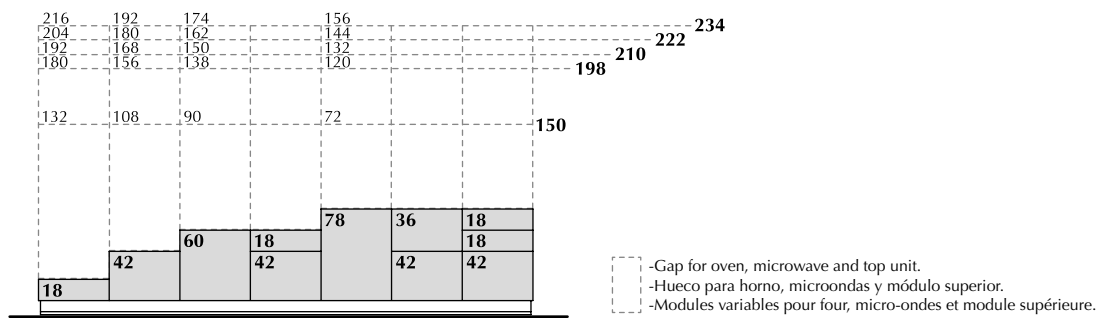

Wall units.

Módulos altos.

Modules hauts.

H: 36 / 48 / 60 / 72 / 84 / 96 / 108 / 120 cm.

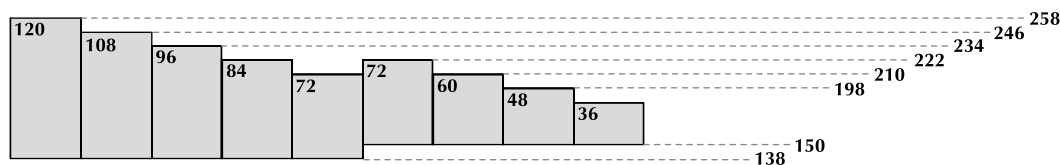

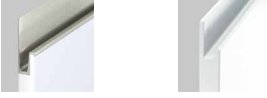

Base units.
Horizontal handle.

Módulos bajos.
Tirador horizontal.

Modules bas.
Poignée horizontale.

H: 18 / 42 / 60 / 78 cm. Wall hung base units and base units / Bajos suspendidos y a tierra / Module bas et module bas suspendu

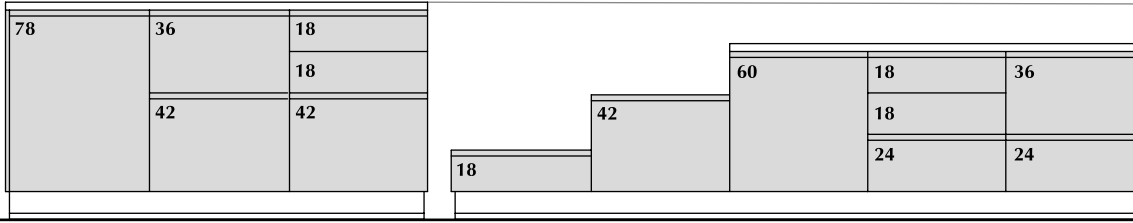

Tower units.
Horizontal handle.

Módulos columna.
Tirador horizontal.

Modules colonne.
Poignée horizontale.

H: 150 / 198 / 210 / 222 / 234 cm.

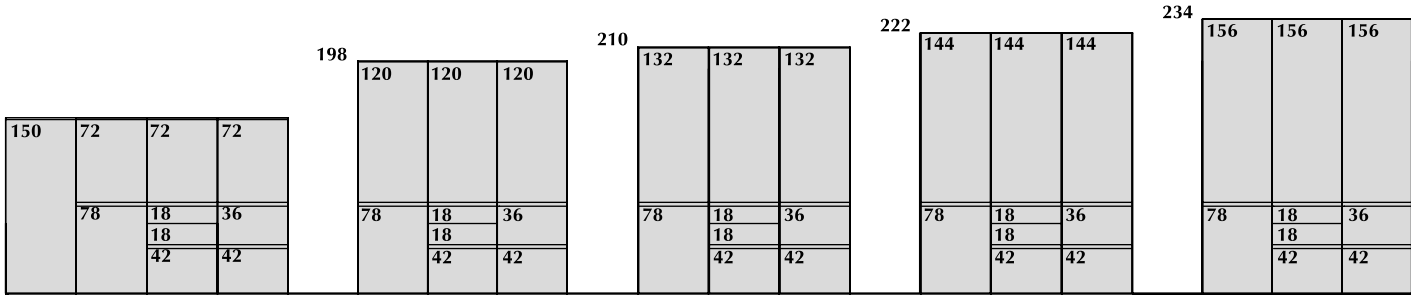

Tower units for oven and microwave.
Horizontal handle.

Columna para horno y microondas.
Tirador horizontal.

Colonne pour four et micro-ondes.
Poignée horizontale.

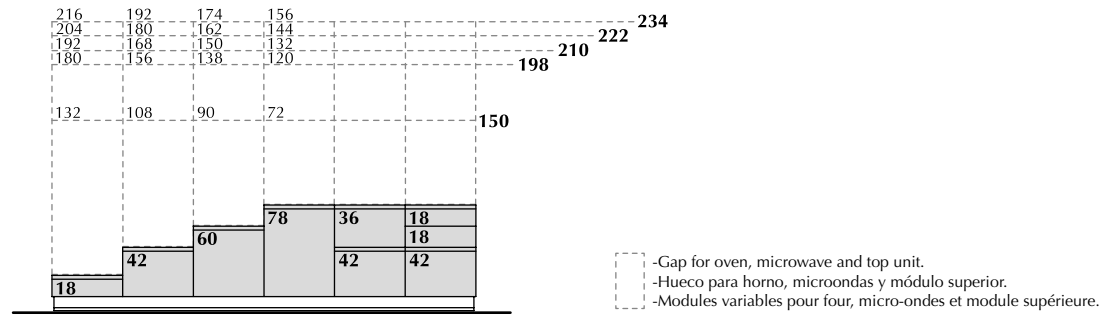

Wall units.
Horizontal handle.

Módulos altos.
Tirador horizontal.

Modules hauts.

H: 36 / 48 / 60 / 72 / 84 / 96 / 120 cm.

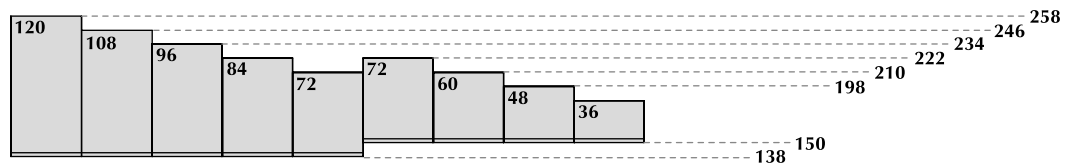



Base units.
 *It requires spacer profile.
 Horizontal handle.

Módulos bajos.
 *Requiere perfil separador.
 Tirador horizontal.

Modules bas.
 *Il nécessite un profil séparateur.
 Poignée horizontale.

H: 18 / 42 / 60 / 78 cm. Wall hung base units and base units / Bajos suspendidos y a tierra / Module bas et module bas suspendu

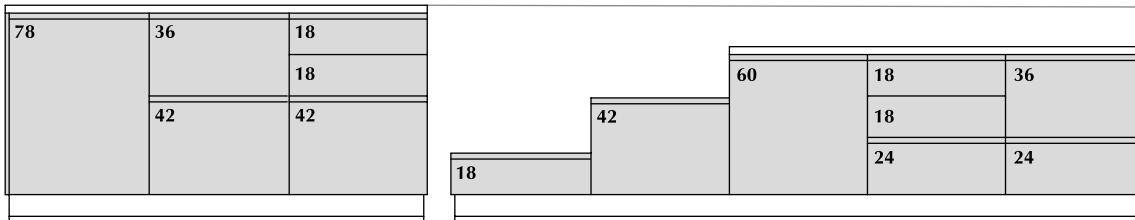

Tower units.
 *It requires spacer profile.
 Vertical handle.

Módulos columna.
 *Requiere perfil separador.
 Tirador vertical.

Modules colonne.
 *Il nécessite un profil séparateur.
 Poignée verticale.

H: 150 / 198 / 210 / 222 / 234 cm.

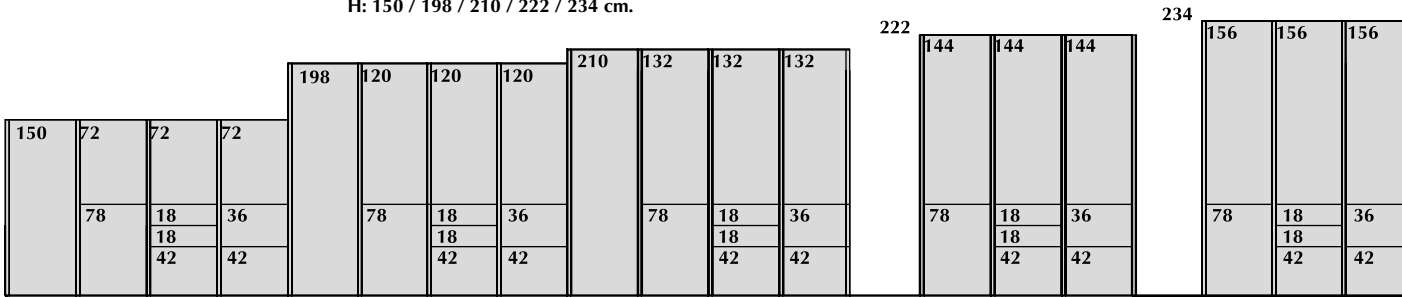

Tower units for oven and microwave.
 *It requires spacer profile.
 Vertical handle.

Columna para horno y microondas.
 *Requiere perfil separador.
 Tirador vertical.

Colonne pour four et micro-ondes.
 *Il nécessite un profil séparateur.
 Poignée verticale.

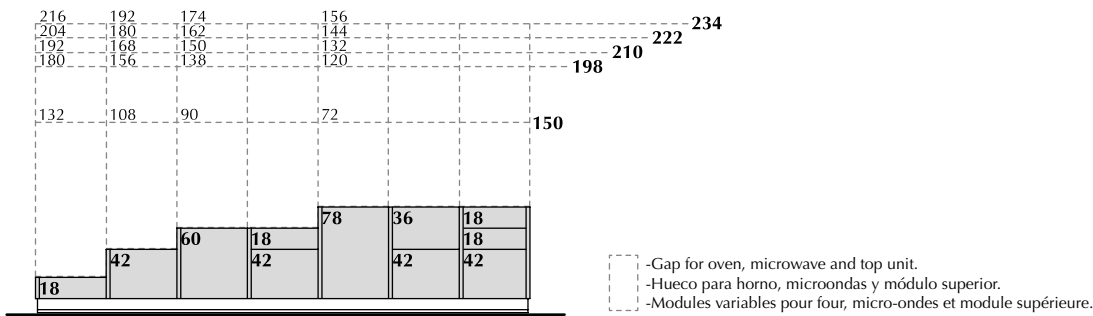

Wall units.
 **The door is 2 cm longer than the carcass.
 Without 60° mitered-mechanized handle.
 Horizontal handle.

Módulos altos.
 **El frente es 2 cm más largo que el casco.
 Sin tirador mecanizado a 60° en el canto.
 Tirador horizontal.

Modules hauts.
 **Le porte est 2 cm plus long que le caisson.
 Sans le poignée usiné coupe en 60° dans le
 chant de la façade.
 Poignée horizontale.

H: 36 / 48 / 60 / 72 / 84 / 96 / 120 cm.

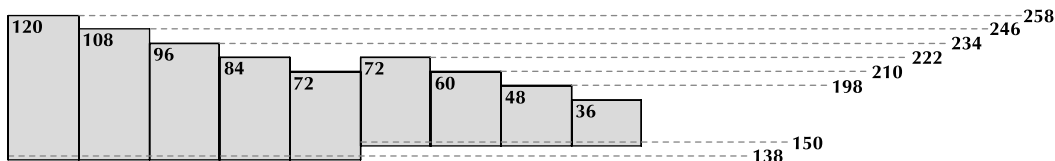
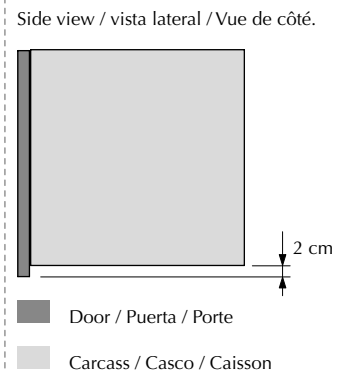

Tower units

Always vertical handle for tower units.
 It is recommended to request support or decorative side panel to place them at the end sides of the modulation.

Módulos columna

Siempre tirador vertical para módulos columna.
 Se recomienda solicitar costado de apoyo o panel decorativo para colocarlos en los extremos de la composición.

Modules colonne

Toujours poignée verticale pour modules colonne.
 Il est recommandé de demander côté de soutien ou panneau décoratif pour les placer sur les côtés d'extrémité de la modulation.

Front view
Vista en alzado
Vue du front

Vertical spacer profile between tower units (30 mm)
 Perfil separador entre módulos columna (30 mm)
 Profil séparateur entre modules colonne (30 mm)

Vertical spacer profile between units without flap for integrated appliances (30 mm)
 Perfil separador entre módulos sin pestaña para eletros. Integrados (30 mm)
 Profil séparateur entre modules sans rabat pour électroménagers intégrés (30 mm)

Drawers, vertical mitered-mechanized handle
 Cajones, tirador vertical en inglete
 Tiroirs, poignée vertical en onglet

End side profile for tower units (30 mm)
 Perfil de terminación para módulos columna (30 mm)
 Profil latéral pour modules colonne (30 mm)

End side profile without flap for integrated appliances (30 mm)
 Perfil de terminación sin pestaña para eletros. Integrados (30 mm)
 Profil latéral sans rabat pour électroménagers intégrés (30 mm)

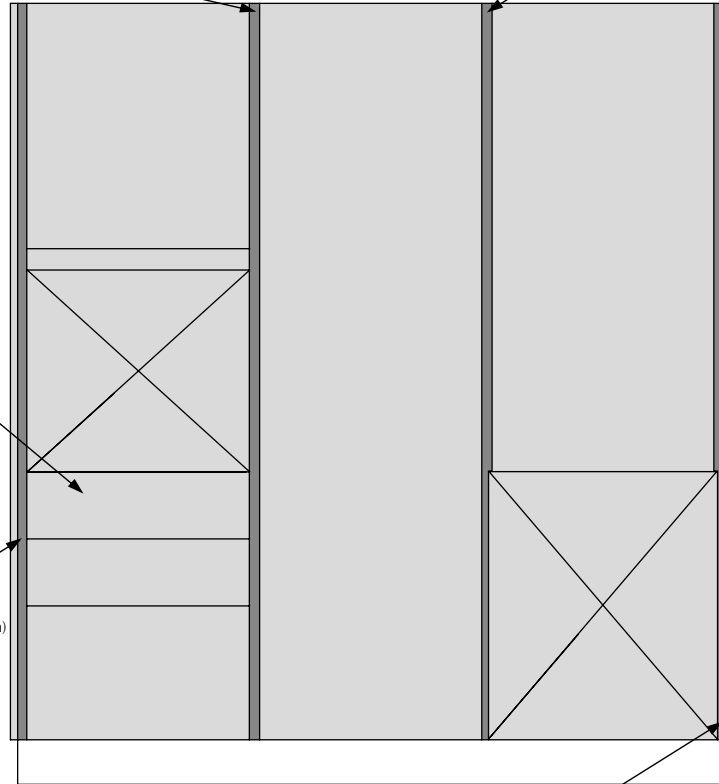

Top view
Vista en planta
Vue du dessus

Support or decorative side panel
 Costado de apoyo o panel decorativo
 Côté de soutien ou panneau décoratif

Support or decorative side panel
 Costado de apoyo o panel decorativo
 Côté de soutien ou panneau décoratif

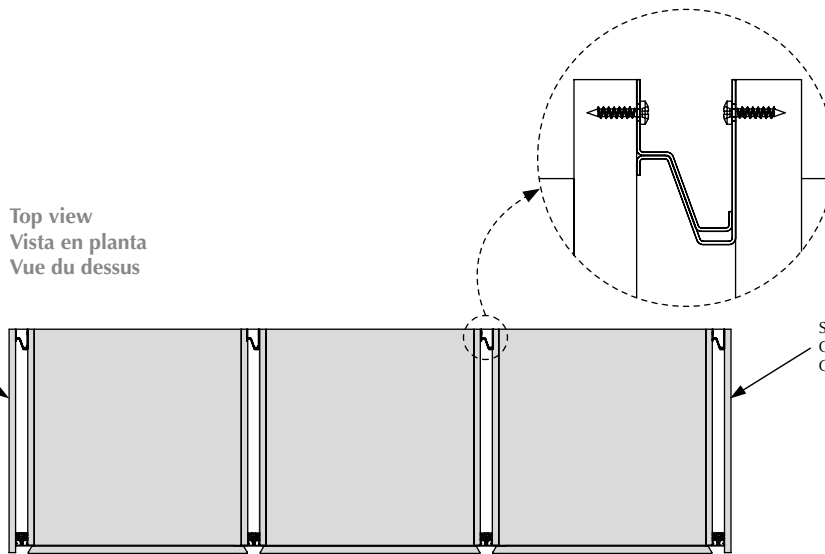

60° mitered-mechanized handle, vertical position
 Tirador mecanizado a 60°, posición vertical
 Poignée usiné coupe en 60°, position vertical

Base and wall units

Wall unit front height is 20 mm more than the carcass height. Without handle mechanization.
 Always horizontal handle for base units.

Módulos bajos y altos

La altura del frente del módulo alto es 20 mm más alta que la altura del casco. Sin mecanizado de tirador.
 Siempre tirador horizontal para módulos bajos.

Modules bas et hauts

La hauteur de la façade du module est 20 mm plus haute que celle du caisson. Sans mécanisation des poignées.
 Toujours poignée horizontale pour modules bas.

Front view
 Vista en alzado
 Vue du front

Side view
 Vista de perfil
 Vue du côté

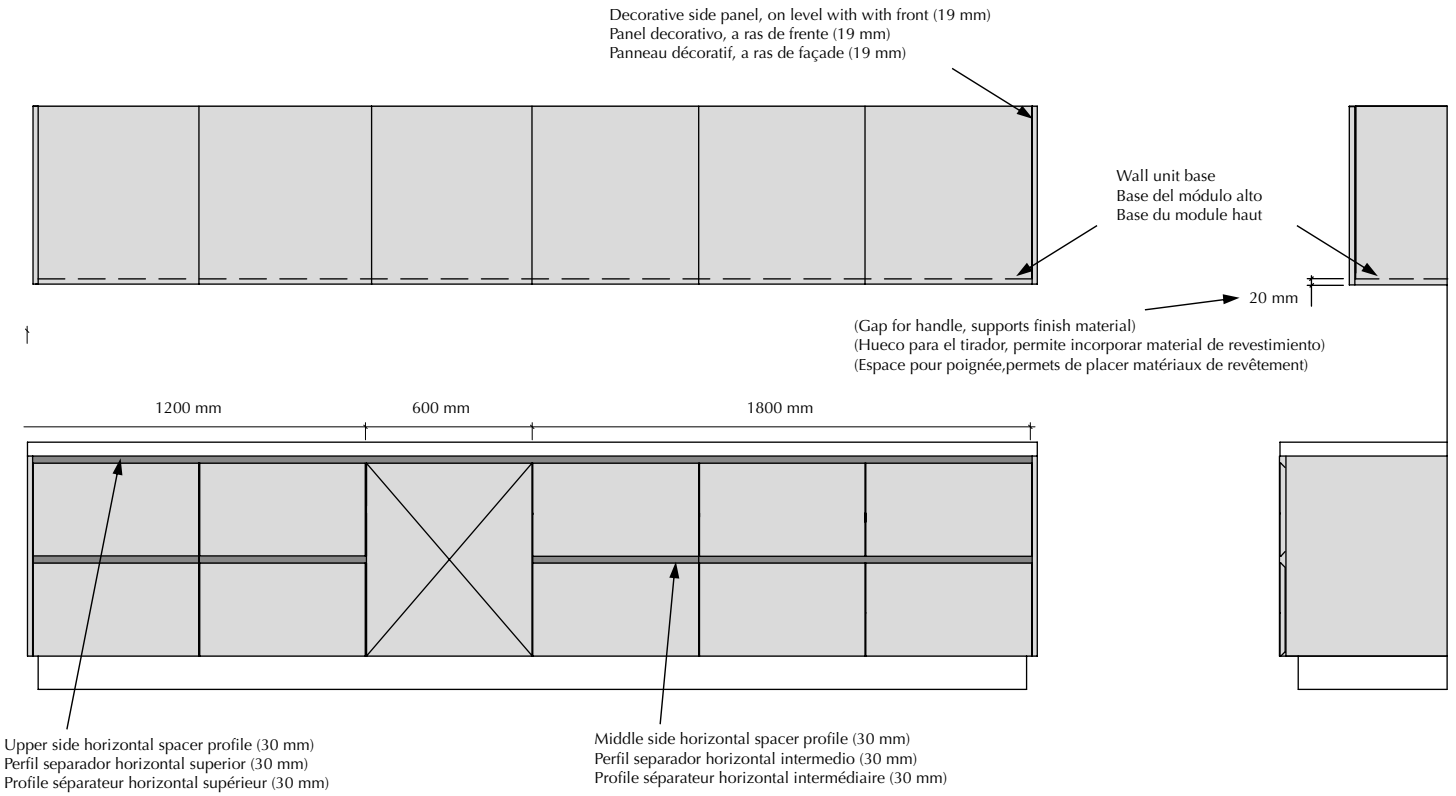

Vertical profile features.
 Profile assembly.

Características del perfil vertical.
 Montaje del perfil.

Caractéristiques du profil vertical.
 Montage du profil.

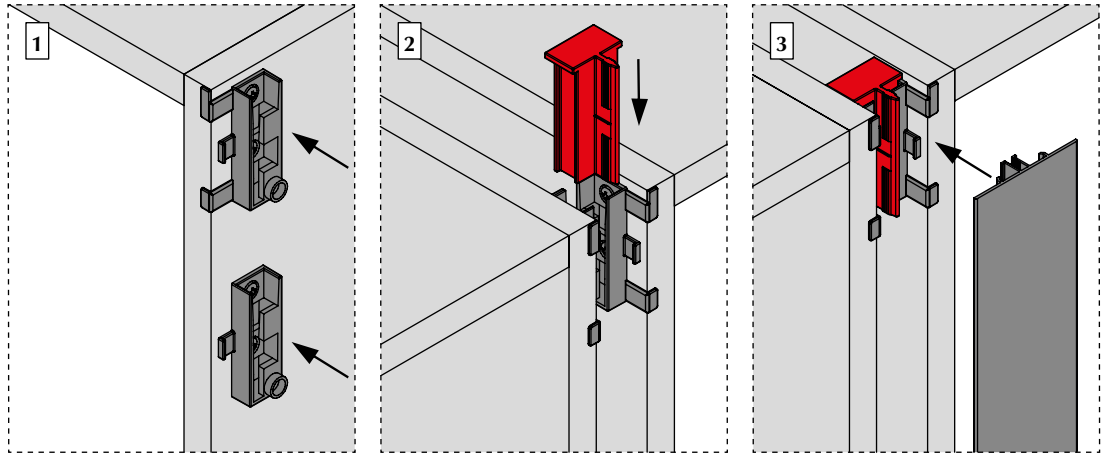

Middle side profile features.
 Base units from models with 60° mite-
 red-mechanized handle incorporate the
 base profile fittings.

Características del perfil intermedio.
 Los módulos bajos de los modelos con
 tirador mecanizado a 60° incorporan el
 herraje con el perfil base.

Caractéristiques du profil intermédiaire.
 Les modules bas des modèles à poignée
 usiné coupe en 60° incorporent les ferrures
 avec le profil de base.

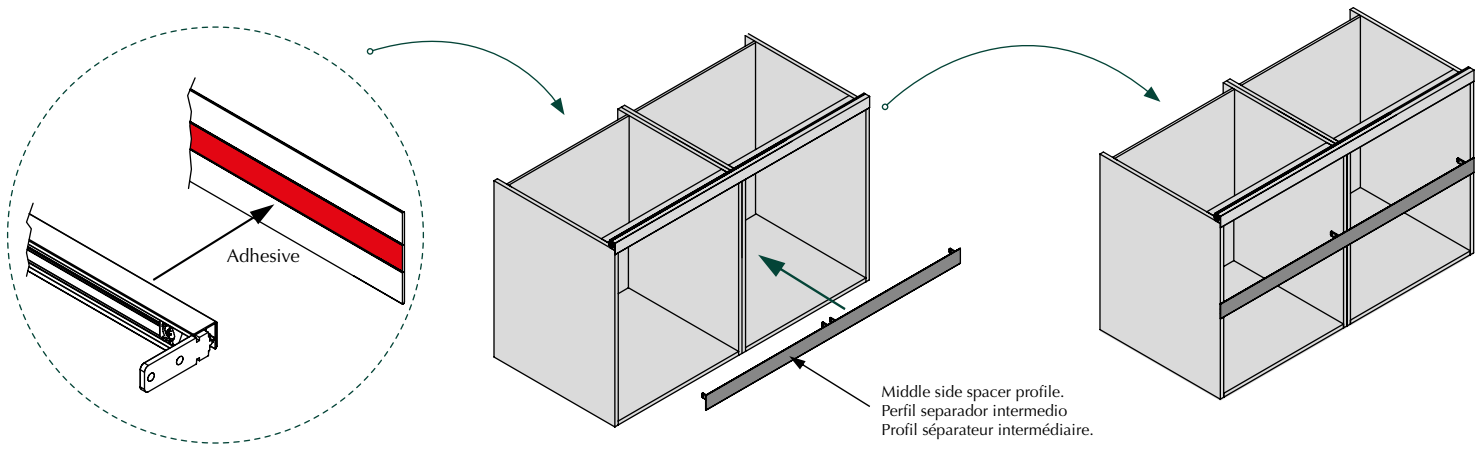

Finish materials under wall units.

**Material de revestimiento bajo el módulo
 alto.**

**Matériau de revêtement sous le module
 haut.**

Without finish materials
Sin material de revestimiento
Sans matériau de revêtement

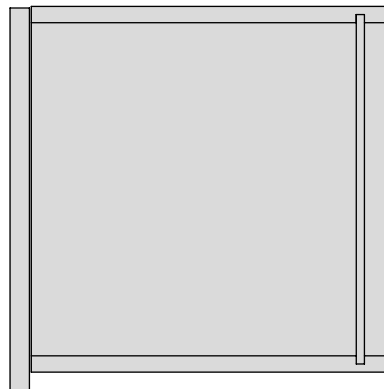

With finish materials
Con material de revestimiento
Avec matériau de revêtement

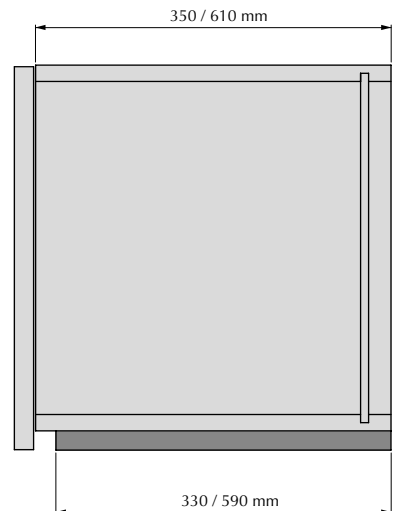

Tower units for oven and microwave. They consist of isolated units which are chosen according to integrated appliances. They are divided into, 1 Carcass unit, 2 Lower units, 3 Shelves for oven and microwave and 4 Upper units.

-Available widths: 60 / 68,6 / 76,2 / 90 / 91,5 cm.
 -Available depths: 61 cm.

Columnas para horno y microondas. Se componen por módulos sueltos que se eligen en función de los electrodomésticos a integrar. Se dividen en, 1 Carcasa, 2 Módulos inferiores, 3 Estantes para hornos / microondas y 4 Módulos superiores.

-Anchos disponibles: 60 / 68,6 / 76,2 / 90 / 91,5 cm.
 -Profundidades disponibles: 61 cm.

Colonnes pour four et micro-ondes. Ils sont composées de modules isolés qui sont choisis en fonction des électroménagers intégrés. Les colonnes sont réparties dans, 1 Caisson, 2 Modules inférieurs, 3 Étagères pour four et micro-ondes, 4 Module supérieur.

-Largeurs disponibles: 60 / 68,6 / 76,2 / 90 / 91,5 cm.
 -Profondeurs disponibles: 61 cm.

1 Carcass unit / Carcasa / Caisson.

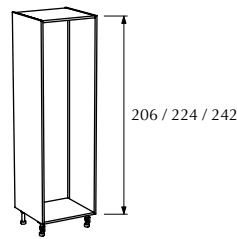

2 Lower units / Módulos inferiores / Modules inférieurs.

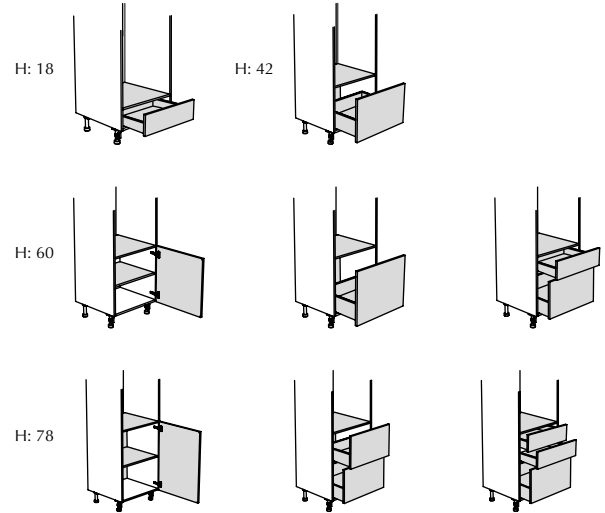

3 Shelves for appliances / Balda para electrodomésticos / Étagères pour électroménager.

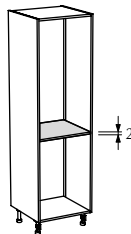

4 Upper unit / Módulo superior / Module supérieur.

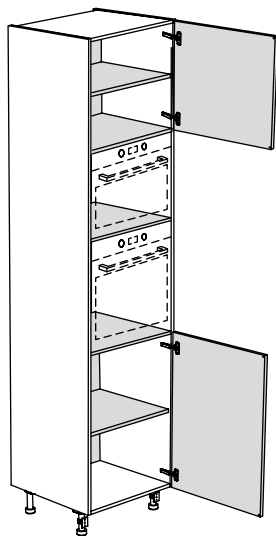
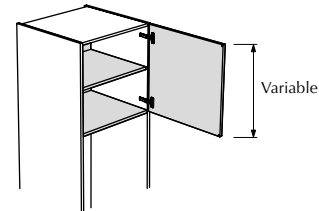

Tower unit construcción:

- 1 Select the carcass unit between available measures.
- 2 Select the lower unit between different options and between available measures.
- 3 Select shelves according to the quantity of ovens / microwaves which are chosen.
- 4 Request the upper unit with the height that remains to complete the tower unit.

Construcción de columna:

- 1 Seleccionar el casco entre las medidas disponibles.
- 2 Seleccionar el módulo inferior entre las distintas opciones y las medidas disponibles.
- 3 Seleccionar baldas en función del número de hornos / microondas que se se escojan.
- 4 Solicitar el módulo superior con la altura que resta para completar la columna.

Construction de colonne:

- 1 Choisir le caisson entre les dimensions disponibles.
- 2 Choisir le module inférieur entre les options et les mesures disponibles.
- 3 Choisir étagères selon la quantité de fours / micro-ondes qui sont sélectionnés.
- 4 Demander le module supérieur avec l'hauteur qui reste à compléter le module colonne.

*How the metal stand works.
 *Cómo funciona la peana de metal.
 *Comment fonctionne le support en métal.

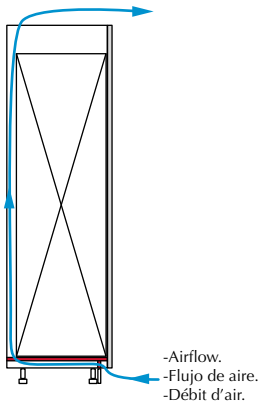

Tower units for fridge.
 They consist of isolated units which are chosen according to integrated appliances.
 They are divided into, 1 Tower unit with hinges, 2 Tower unit without hinges.
 -Available widths: 60 cm.
 -Available depths: 60 cm.
 *It has a metal stand to place the appliance. It creates a strong union and offers good ventilation for fridge aeration without using a ventilation grille.

Módulos columna para frigorífico.
 Se componen por módulos sueltos que se eligen en función de los electrodomésticos a integrar.
 Se dividen en, 1 Módulo con bisagras, 2 Módulo sin bisagras.
 -Anchos disponibles: 60 cm.
 -Profundidades disponibles: 60 cm.
 *Dispone de una peana metálica sobre la que se apoya el frigorífico, ofreciendo robustez y ventilación suficiente, sin necesidad de utilizar zócalo con rejilla de ventilación.

Modules colonne pour réfrigérateur.
 Ils sont composées de modules isolés qui sont choisies en fonction des électroménagers intégrés.
 Les colonnes sont réparties dans, 1 Colonne avec charnières, 2 Colonne sans charnières.
 -Largeurs disponibles: 60 cm.
 -Profondeurs disponibles: 60 cm.
 *Disposent d'un support en métal pour placer l'appareil. Il crée une composition solide et une bonne aération pour le réfrigérateur sans l'aide d'une grille d'aération.

1 Carcass unit with hinges / Carcasa con bisagras / Caisson avec charnières.

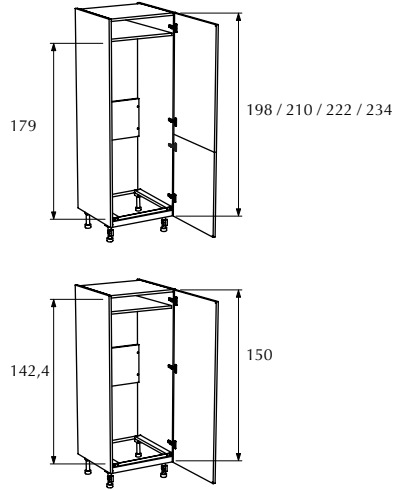



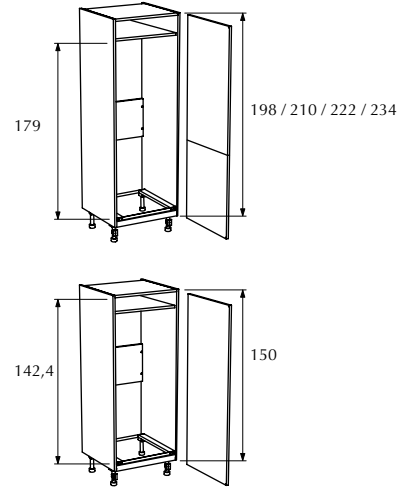

2 Carcass unit without hinges / Carcasa sin bisagras / Caisson sans charnières.







The installation measurements indicated are calculated for models with standard configurations. The "Planit" aid programme automatically offers details on individual units, taking into account the particular measurements of the layout design.

Las medidas de instalación que se indican están efectuadas sobre módulos con configuraciones básicas. En el programa de asistencia Planit, se acotan individual y automáticamente sobre cada módulo, teniendo en cuenta las medidas particulares de distribución de huecos.

Les dimensions d'installation indiquées sont effectuées sur la base de modules à configuration basique. Dans le logiciel d'aide "Planit", les dimensions sont cotées de façon individuelle et automatique sur chaque module, compte tenu des dimensions particulières de distribution des espaces vides.

-  Cold water pipe.
Toma para agua fría.
Prise d'eau froide.
-  Hot and cold water pipes, 15 cm separation between centres.
Tomas para agua caliente y fría, separadas entre centros 15 cm.
Prises d'eau chaude et froide, espacées de 15 cm entre ses axes.
-  Drain.
Desagüe.
Sortie d'eau.
-  Set of pipes for sink, hot and cold water and drain
Grupo de tomas para fregadero, agua caliente y fría, y desagüe
Groupe de prises pour évier, eau chaude, eau froide et sortie d'eau.
-  Socket element with earth connection
Enchufe con toma de tierra
Prise électrique avec prise de terre.

-  Typical dishwasher installation set, made up of socket with earth connection, cold water pipe and drain.
Grupo de tomas típico para lavavajillas, compuesto de enchufe con toma de tierra, agua fría y desagüe.
Groupe de prises conventionnel pour lave-vaisselle, composé de prise électrique avec prise de terre, prise d'eau froide et sortie d'eau.
-  Socket element for oven, hob or microwave.
Caja de conexión para horno, placa o microondas.
Boîtier de connexion pour four, cuisinière électrique ou micro-ondes.
-  Double socket element for oven and hob.
Caja de conexión doble, para horno y placa.
Double boîtier de connexion, pour four et cuisinière électrique.
-  15 cm diameter smoke outlet.
Salida para humos, de 15 cm. de diámetro.
Sortie de fumée, 15 cm de diamètre.

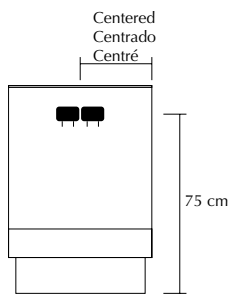

Base unit for oven and hob
 Bajo para horno y placa
 Bas pour four et plaque de cuisson

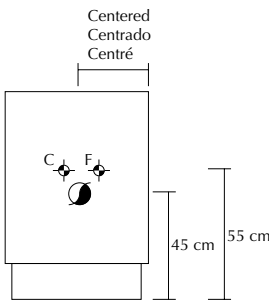

Base unit for sink
 Bajo para fregadero
 Bas pour évier

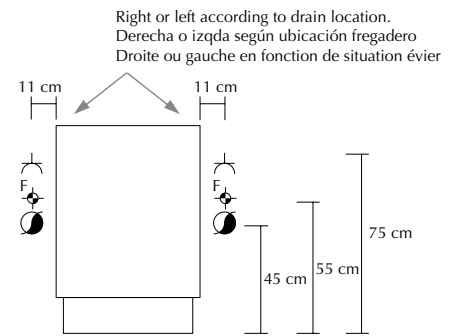

Installation set for dish washer
 Conexiones para lavavajillas
 Conexions pour lave-vaisselle

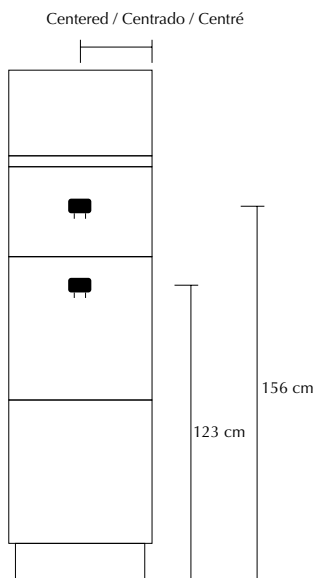

Tower unit for oven and microwave
 Columna para horno y microondas
 Colonne pour four et micro-ondes

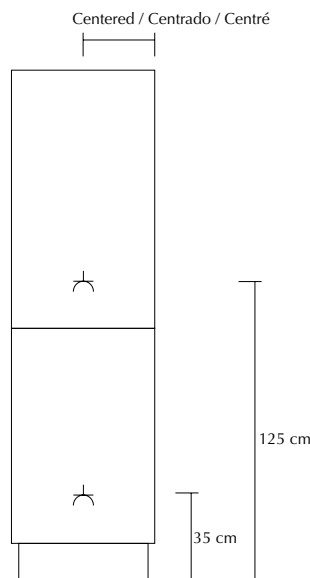

Tower unit for refrigerator and freezer
 Columna para frigorífico y congelador
 Colonne pour réfrigérateur et congélateur

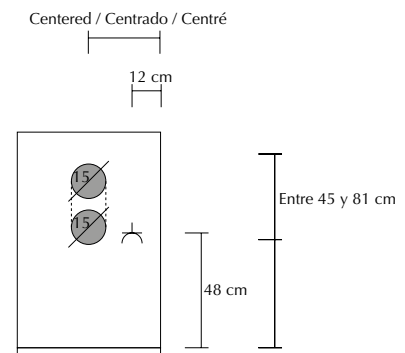

Wall unit for extractor
 Alto para extractor
 Haut pour hotte

ENG_WARRANTY FOR GAMA-DECOR RESIDENCE KITCHEN FURNITURE (V.01/2012)**Scope of the Guarantee:**

This Manufacturer's Guarantee covers any claims for manufacturing defects affecting Gama-Decor brand furniture that are not visible during installation and which may appear with use or over time, for a period of TWO YEARS from the date of delivery to the first user, except in the case of consumable elements such as light bulbs, pistons, etc., for which Gama-Decor provides a guarantee of ONE YEAR. In the case of kitchens supplied for developments and building projects, the guarantee period will be calculated from the date on which the kitchens are supplied/certified.

This Guarantee does not cover the normal changes that affect wood, like any natural product, with the passing of time, as well as differences in its tone or grain.

During the period covered by this Guarantee, Gama-Decor reserves the right to modify the technical and design specifications of its products without prior notice. This Guarantee replaces any previous versions of the same.

Guarantee Conditions:

- That the Gama-Decor kitchen furniture has been acquired from a certified distributor.
- That it has not undergone any alterations since it left the factory, and that all of its component features are respected.
- That any claims are not a result of causes beyond the control of Gama-Decor, such as leaks, overly high temperatures, abnormal humidity conditions, incorrect assembly, impacts, abusive or unsuitable use, unsuitable cleaning products, changes in tone due to exposure to sunlight, etc.
- That all recommendations regarding use and maintenance have been respected.
- That the products have not been used, nor displayed for an undefined period in any showrooms, trade fairs or exhibitions, in which case the guarantee period for these articles is 30 DAYS.

Presentation of Claims:

Any fault identified in our products must be notified to the Certified Distributor who supplied or sold our products, or to a certified technical service provider. Any such notification must be made within a reasonable period of time from discovering the fault, in order to avoid any worsening of the situation. In any event, the execution and effective coverage of the guarantee offered for our products will be subject to an inspection carried out by the certified distributor who sold or supplied the products, or the certified provider of the supposedly faulty products.

In the event of Gama-Decor recognising that the affected element is faulty and within the limits of the Guarantee, it will propose either repairing or replacing the same, as applicable.

In these cases, Gama-Decor will provide the Distributor or technical service provider with:

- The materials that have had the original faults or defects repaired.
- New materials with identical characteristics, if Gama-Decor has opted to replace the faulty material, or if the repair is not satisfactory.
- In situations when the material in question is no longer available, it cannot be provided by our supplier, or the supplier has changed its activity, etc, Gama-Decor will offer an alternative solution.

NOTE: The Guarantee document will be applicable without prejudice to the rights of the consumer established by law in each country, as well as the Europe Community regulations.

ESP_GARANTÍA MUEBLES DE COCINA GAMA-DECOR RESIDENCE (V.01/2012)**Alcance de la Garantía:**

Esta Garantía del fabricante cubre cualquier posible reclamación por defectos de fabricación de los muebles marca Gama-Decor, no visibles durante la instalación y que puedan aparecer con el uso o con el paso del tiempo, durante un periodo de DOS AÑOS, contando a partir de la fecha de entrega al primer usuario, excepto en el caso de bienes consumibles como lámparas, pistones, etc... en los cuales Gama-Decor ofrece un periodo de UN AÑO. En el caso de cocinas suministradas en promociones, obras, etc... el periodo de garantía contará a partir de la fecha de suministro / certificación de las mismas.

Se excluyen de esta Garantía las evoluciones normales que la madera, como todo producto natural, pueda sufrir con el paso del tiempo, así como las diferencias de matiz o veta de la misma.

Durante la vigencia de la presente garantía Gama-Decor se reserva, sin previo aviso, la posibilidad de modificar las especificaciones técnicas y de diseño de sus productos. Esta garantía anula las anteriores versiones de la misma.

Condicionamiento de la Garantía:

- Que el amueblamiento de cocina Gama-Decor haya sido adquirido a un Distribuidor Oficial.
- Que no hayan sido alterados desde su salida de fábrica, debiéndose respetar en cualquier caso la totalidad de sus características de composición.
- Que la reclamación no sea consecuencia de causas ajenas a Gama-Decor, tales como filtraciones de agua, temperaturas demasiado elevadas, condiciones de humedad anormales, deficiencias en el montaje, golpes, usos abusivos o no previstos, productos de limpieza no adecuados, cambios de tono debidos a la luz solar, etc.
- Que se hayan respetado todas las recomendaciones de uso y mantenimiento.
- Que los productos no hayan sido utilizados, ni hayan estado expuestos por tiempo indefinido en cualquier sala, feria o exposición, siendo el período de garantía de estos artículos de 30 DÍAS.

Formalización de una reclamación:

Cualquier defecto que se localice en nuestros productos, debe ser notificado al Distribuidor Oficial que ha suministrado o vendido nuestros productos o a un servicio técnico autorizado. La mencionada comunicación deberá efectuarse en periodo de tiempo razonable desde el momento en que el defecto fue detectado, para evitar el posible agravamiento de las consecuencias del mismo. En todo caso, la ejecución y el efectivo amparo de la garantía ofrecida a nuestros productos, estará supeditada a la preceptiva inspección que, el Distribuidor Oficial que realizó la venta o suministro o al servicio técnico autorizado, debe efectuar sobre los supuestos productos defectuosos.

Si Gama-Decor reconoce defectuosa la parte afectada, y dentro de los Límites de la Garantía, propondrá si corresponde reparar o reemplazar la misma.

En estos casos, Gama-Decor proveerá al Distribuidor o servicio técnico, de:

- Los materiales reparados de los vicios o defectos originarios.
- Materiales nuevos de idénticas características, en los casos en que Gama-Decor haya optado por reemplazar el material defectuoso o en los supuestos en que la reparación no fuera satisfactoria.
- En los casos en que, por caducidad de los materiales, imposibilidad de suministro por parte de nuestro proveedor, que dicho proveedor haya cambiado de actividad, etc., Gama-Decor ofrecerá una solución alternativa.

NOTA: El documento de garantía, será de aplicabilidad, sin perjuicio de los derechos de los consumidores establecidos por la Ley vigente en cada país, así como lo dispuesto en la normativa comunitaria europea.

FRA_GARANTIE SUR LE MOBILIER DE CUISINE DE GAMADDECOR PROJECTS (V.01/2012)**Étendue de la garantie :**

La présente garantie du fabricant couvre toute réclamation éventuelle due à des défauts de fabrication des meubles de la marque Gama-Dekor, non visibles au moment de leur installation et susceptibles d'apparaître dans le cadre de leur utilisation ou au fil du temps, pendant une période de DEUX ANS à compter de la date de livraison au premier utilisateur, à l'exception des produits consommables tels que les lampes, vérins, etc., pour lesquels la garantie de Gama-Dekor est limitée à UN AN. Dans le cas des cuisines fournies dans le cadre de promotions immobilières et autres projets de construction, etc., la période de garantie prendra effet à compter de la date de la livraison / certification de celles-ci.

Sont exclus de la présente garantie les phénomènes dus à l'évolution normale de tels que le bois, comme tout autre produit naturel, est susceptible de subir au fil du temps, de même que les différences de tons ou de veines de celui-ci.

Pendant la période d'application de la présente garantie, Gama-Dekor se réserve le droit de modifier sans préavis les spécifications techniques et de conception de ses produits. La présente garantie annule les versions précédentes de celle-ci.

Conditions d'application de la garantie :

- Les meubles de cuisine Gama-Dekor doivent avoir été achetés auprès d'un distributeur officiel.
- Les meubles ne peuvent pas avoir été modifiés depuis leur départ de l'usine, la totalité de leurs caractéristiques de composition devant être respectée dans tous les cas.
- La réclamation ne peut pas être le fruit de causes étrangères à Gama-Dekor, comme par exemple des filtrations d'eau, des températures excessivement élevées, des conditions d'humidité anormales, des défauts de montage, des coups, une utilisation abusive ou non prévue, des produits de nettoyage inappropriés, des changements de ton dus à la lumière solaire, etc.
- Toutes les recommandations relatives à l'utilisation et à l'entretien doivent avoir été respectées.
- Les produits ne peuvent avoir été utilisés ou exposés pendant une période indéfinie dans aucun type de foires, de salons ou d'expositions, la période de garantie de ces articles étant de 30 JOURS.

Formalisation d'une réclamation :

Tout défaut affectant nos produits doit être notifié au distributeur officiel qui a livré ou vendu ceux-ci ou à un service technique autorisé. La notification mentionnée doit être réalisée dans un délai raisonnable à partir du moment où le défaut a été constaté, de manière à éviter toute aggravation éventuelle des conséquences de celui-ci. Dans tous les cas, l'exécution et le recours effectif à la garantie qui couvre nos produits sont sujets à l'inspection que le distributeur officiel qui a réalisé la vente ou la livraison, ou le service technique autorisé, devra réaliser obligatoirement concernant les produits présumés défectueux.

Si Gama-Dekor reconnaît la défectuosité de la partie affectée, et dans les limites de la garantie, elle proposera soit de réparer soit de remplacer celle-ci.

Dans ces cas, Gama-Dekor fournira au distributeur ou au service technique :

- Les matériels réparés des vices ou défauts apparus.
- Des matériels neufs possédant des caractéristiques identiques, dans les cas où Gama-Dekor aurait choisi de remplacer le matériel défectueux ou dans ceux où la réparation ne serait pas satisfaisante.
- Dans les cas où les matériels ne seraient plus fabriqués, d'impossibilité de livraison par notre fournisseur ou de changement d'activité de ce dernier, etc., Gama-Dekor proposera des solutions alternatives.

REMARQUE : Le bon de garantie sera applicable sans préjudice des droits des consommateurs tels qu'établis dans la législation en vigueur dans chaque pays, de même que des dispositions contenues dans la réglementation communautaire européenne.

USA WARRANTY RESIDENCE KITCHEN FURNITURE GAMADDECOR (V. 01/2016)**Scope of the Warranty:**

This Manufacturer's Warranty covers any claims for manufacturing defects affecting GAMADDECOR brand furniture that are not visible during installation and which may appear with use or over time, for a period of TWO YEARS from the date of delivery to the first user, except in the case of consumable elements such as light bulbs, pistons, etc., for which GAMADDECOR provides a warranty of ONE YEAR.

In the case of kitchens supplied for developments and building projects, the warranty period will be calculated from the date on which the kitchens are supplied/certified.

This Warranty does not cover the normal changes that affect wood, like any natural product, with the passing of time, as well as differences in its tone or grain.

During the period covered by this Warranty, GAMADDECOR reserves the right to modify the technical and design specifications of its products without prior notice. This Warranty replaces any previous versions of the same.

Warranty Conditions:

- That the GAMADDECOR kitchen furniture has been acquired from a certified distributor.
- That it has not undergone any alterations since it left the factory, and that all of its component features are respected.
- That any claims are not a result of causes beyond the control of GAMADDECOR, such as leaks, overly high temperatures, abnormal humidity conditions, incorrect assembly, impacts, abusive or unsuitable use, unsuitable cleaning products, changes in tone due to exposure to sunlight, etc.
- That all recommendations regarding use and maintenance have been respected.
- That the products have not been used, nor displayed for an undefined period in any showrooms, trade fairs or exhibitions, in which case the warranty period for these articles is 30 DAYS.

Presentation of Claims:

Any fault identified in our products must be notified to the Certified Distributor who supplied or sold our products, or to a certified technical service provider. Any such notification must be made within a reasonable period of time from discovering the fault, in order to avoid any worsening of the situation. In any event, the execution and effective coverage of the warranty offered for our products will be subject to an inspection carried out by the certified distributor who sold or supplied the products, or the certified provider of the supposedly faulty products.

In the event GAMADDECOR recognizes that the affected element is faulty and within the limits of the Warranty, it will propose either repairing or replacing the same, as applicable.

In these cases, GAMADDECOR will provide the Distributor or technical service provider with:

- The materials that have had the original faults or defects repaired.
- New materials with identical characteristics, if GAMADDECOR has opted to replace the faulty material, or if the repair is not satisfactory.
- In situations when the material in question is no longer available, it cannot be provided by our supplier, or the supplier has changed its activity, etc., GAMADDECOR will offer an alternative solution.

EXCEPT AS EXPRESSLY SET FORTH ABOVE, GAMADDECOR MAKES NO WARRANTIES, EXPRESS OR IMPLIED, REGARDING ITS PRODUCTS, AND HEREBY DISCLAIMS ANY AND ALL IMPLIED WARRANTIES, INCLUDING WITHOUT LIMITATION ANY IMPLIED WARRANTIES OF MERCHANTABILITY OR FITNESS FOR A PARTICULAR PURPOSE.

To the maximum extent permitted by applicable law, GAMADDECOR expressly excludes from this warranty, and will not pay for, any damages, including without limitation direct or indirect, consequential, special or punitive damages. This warranty extends only to the end user and is not transferable.

This warranty gives the end user specific legal rights, and he or she may also have other rights that vary from state to state. GAMADDECOR will not be responsible for any statements or representations made in any form that go beyond, are broader than, or are inconsistent with any authorized literature or written specifications furnished by GAMADDECOR. Some states do not allow limitations on how long an implied warranty lasts, or on special, incidental, or consequential damages. As a result, some of these limitations may not apply to the end user.

ENG.

1. Introduction

Thank you for having chosen Gamadecor when selecting your kitchen.

In order to your kitchen continues to look new for a long time and you can keep it in perfect condition, please read the following practical tips for cleaning and maintenance.

Because of its daily use, a kitchen has to meet high-level demands. That is the reason why all materials we use for its manufacture are top quality. The manufacturing process has been controlled in its different stages with the purpose of obtaining a reliable product, which can offer the same features of use for many years.

2. Cleaning and maintenance tips

It is advisable to clean the kitchen frequently instead of doing it more thoroughly at longer intervals. In spite of the endurance of the surfaces, dirt tends to build up over time. In order to void the use of abrasive cleaning products, clean it regularly at short intervals.

The maintenance of Gamadecor kitchens is quite simple. However, when cleaning them, you should never use such utensils and cleaning products as sharp objects, rough scouring pads, solvents, bleach, nail polish remover, vinegar, citric acid, abrasive products, polishes, etc.

Due to its composition, texture, finish, hardness, etc., the materials of Gamadecor kitchens require some special care, which we describe as follows:

Cleaning in general:

To eliminate dust, grease stains, fingerprints and cooking fumes, dissolve some mild soap in a container of warm water. Wipe the cabinets with a damp cloth and then dry all surfaces, specially the corners, with a soft clean dry cloth.

If you have any doubts about the effect a cleaning product might have on a surface, we recommend trying it in a less visible place to check for any changes in colour or other alterations.

Cleaning products that give off corrosive vapours may alter the finish of metal fittings and accessories inside a sink base unit or a cleaning product unit. Make sure caps are always on tight.

Wet cloths and sponges dry badly inside the cabinets. Over time, its humidity may cause surrounding materials to oxidize.

Laminate surfaces:

They are the easiest to clean and there are no special instructions.

Stainless steel surfaces:

On the market, there are many products that are suitable for cleaning all stainless steel items like fronts, hobs, hoods, ovens, etc. Please, follow the manufacturer's instructions, which usually appear on the packaging. You can also get them from a Gamadecor distributor.

Chromium/nickel plated handles:

The finish of handles is obtained from an electrolytic bath. They can be cleaned with the same materials you use for laminate or wood fronts.

In case of resistant stains or scratches, try polishing with products of the automobile sector.

Metal filters of hoods:

Most modern hoods are equipped with metal filters. Do not replace them. Put them in the dishwasher. You will get better cleaning results if they are put vertically. How often they should be cleaned depends on the intensity of use but generally, every fourteen days. Please, follow the manufacturer's recommendations.

Glass surfaces:

You can clean them with the same products you use for cleaning windowpanes and the like.

Cleaning of plinth space:

The frontal strips of the plinth have a mechanism, which makes them easy to assemble and disassemble when cleaning the space of the plinth under the base units.

Wood and laminate worktops:

Solid wood worktops require continual maintenance to guarantee its resistance to humidity. Gamadecor has a product for this purpose that comes along with instructions of use. If this product has not been furnished together with the worktop, please contact the Gamadecor distributor you have bought your kitchen from.

Laminate worktops do not require special cleaning.

In spite of their qualities, laminate and wood worktops are not resistant to high temperatures. Thus, the need to use heat resistant mats. To avoid cutting the surface, we recommend the use of a base either made of wood, granite or synthetic material.

Quartz and glass agglomerate worktops (Silestone type) / Acrylic resin worktops (Kron® type) / Stainless steel worktops / Granite worktops:

For the cleaning and maintenance of these worktops, follow the specific instructions of each manufacturer.

Ask either the installer of the worktop installer or the Gamadecor distributor for information.

3. Measures to avoid damages caused by water

General:

Do not use vapour steam cleaners to clean your cabinets. The pressure of the water vapour filters into the materials and causes a swelling, which damages the units seriously.

Keep all surfaces dry avoiding frequent and prolonged spillages of liquid food, either cold or hot.

Sink units:

They are supplied from the factory with a metal base and so they are totally protected in case of water leak. Make sure the traps are always tightly closed. If you open them for cleaning, always put a container to collect the water.

Dishwashers:

Avoid as much as possible that the water vapour, which are produced by the dishwasher when finishing its washing cycle, affects the cabinets and worktop. Wait until the interior cools down before opening the door. Please follow the recommendations of the dishwasher manufacturer.

Tower units for integrated refrigerators:

They are supplied from the factory with a metal base to avoid water leaks during the defrosting process.

We recommend keeping the defrosting process under control in order to avoid water leaks on the floor.

Hoods:

We recommend to keep the hood working whenever you are cooking even if it is only for boiling water. The aspiration reduces grease build-up and water condensation on the surfaces of your kitchen.

Plinth fronts:

Aluminium plinth fronts are totally resistant to humidity and can be cleaned with lots of water. Wood veneer fronts with a multilayer vase should be cleaned like all wood surfaces, avoiding direct contact with water.

Joints/cut-outs/wall joints of all kind of worktops:

Worktop joints, wall joints and cut-outs on the surface for hobs, sinks, etc. must be sealed during assembly so they are totally impervious to water. This will prevent, in the first place, the filtration of humidity into base units and secondly, damage to worktops (specially laminate ones) caused by humidity filtration. The best way to avoid filtrations of water is to always dry the worktop after using it and periodically check that the sealing of the joints is in good condition.

4. Atmosphere conditions

Wood is a natural product that reacts to changes in temperature and above all to a humid atmosphere with expansions and contractions. The atmosphere humidity should range between 55 to 70 % and the temperature, between 18 to 22° C. In order to achieve these ideal conditions, we recommend to take the following precautions:

Using humidifiers or, if this is not possible, keeping a container with water in it somewhere in the kitchen when the central heating is working.

Recently built houses usually have an atmosphere humidity of over 70%. Here, good ventilation is essential.

Seaside and countryside climates are the ones with the biggest differences in atmosphere humidity. Thus, it is necessary to maximize the precautions in these areas.

As an additional measure to keep the beauty of your kitchen, we recommend preventing the sunrays from falling directly on the wood. In spite of the quality of the lacquers, which contain components that protect the wood against ultra-violet radiation, wood can suffer discoloration as time goes by if directly and continually exposed to sunlight.

ESP.

1. Introducción

Agradecemos la preferencia por la marca Gamadecor en la elección de su cocina.

Para que su nueva cocina lo siga siendo durante mucho tiempo, y con el fin de que Ud. pueda mantenerla en perfecto estado de conservación, le rogamos que dedique unos momentos a la lectura de unos consejos prácticos de limpieza y mantenimiento.

Por el uso diario, la cocina está sometida a unos altos niveles de exigencia. Por este motivo, todos los materiales que se emplean para su fabricación son de máxima calidad. El proceso de fabricación se ha controlado en sus distintas fases, con el objetivo de obtener un producto fiable que conserve sus características de uso durante muchos años.

2. Consejos de limpieza y mantenimiento.

Es conveniente realizar limpiezas con frecuencia y no una limpieza en profundidad en mayores espacios de tiempo. A pesar de las características de resistencia de las superficies, la suciedad al cabo del tiempo tiende a incrustarse. Para evitar tener que recurrir a productos de limpieza excesivamente agresivos es preferible realizar limpiezas frecuentes, antes que profundas con carácter esporádico.

El mantenimiento de las cocinas Gamadecor es sencillo. Sin embargo desaconsejamos el uso de ciertos utensilios y productos que jamás se deben emplear para su limpieza, como pudieran ser: objetos punzantes, estropajos con una superficie áspera, disolventes, lejías, quitaesmaltes, vinagres, ácidos cítricos, productos abrasivos, abrillantadores, etc.

Por su composición, textura, acabado, grado de dureza, etc. los materiales de la cocina Gamadecor requieren algunos cuidados específicos, los cuales relacionamos a continuación:

Limpieza en general:

Para la eliminación de motas de polvo, manchas de grasa, huellas dactilares y vapores de cocción, disuelva jabón neutro en un recipiente de agua templada. Limpie los muebles con una bayeta humedecida, secando a continuación todas las superficies, especialmente las esquinas, con un paño suave, limpio y seco.

En caso de duda sobre la reacción de un producto de limpieza elegido sobre una superficie, recomendamos hacer unas pruebas en un sitio menos visible para comprobar posibles alteraciones de color y otros efectos.

Los productos de limpieza que desprenden vapores corrosivos pueden alterar el acabado de los herrajes y accesorios en el interior de un mueble bajo fregadero o limpieza. Asegúrese de que los tapones siempre estén correctamente cerrados.

Las bayetas y esponjas húmedas se secan con dificultad dentro de los muebles. Su humedad puede producir, con el tiempo, signos de oxidación de los materiales de entorno.

Superficies de laminado:

Son las más sencillas de limpiar, y no existen indicaciones especiales.

Superficies de acero inoxidable:

En el mercado existen diversos productos adecuados para la limpieza de todos los elementos de acero, como son frentes, campanas, hornos, etc. Rogamos seguir las instrucciones del fabricante, que suelen estar indicados sobre los envases. También se pueden adquirir a través de un distribuidor Gamadecor.

Tiradores con superficies cromadas/niqueladas:

El acabado de los tiradores se obtiene mediante un baño electrolítico. Para su limpieza se pueden emplear los mismos materiales que para los frentes de laminado o madera.

En caso de manchas resistentes o arañazos, intentar pulir con productos del sector automovilístico.

Filtros metálicos de campanas extractoras:

La gran mayoría de las campanas modernas están equipadas con filtros metálicos. Éstos no se cambian, sino que se limpian en el lavavajillas. Se limpian mejor si los coloca en posición vertical. La frecuencia de la limpieza depende de la intensidad del uso, pero por regla general una vez cada 14 días. (Rogamos seguir las recomendaciones del fabricante).

Superficies de cristal:

Se pueden usar los mismos productos y materiales como para la limpieza de cristales de ventanas, etc.

Limpieza del espacio de zócalo:

Las tiras frontales del zócalo llevan un mecanismo de fácil montaje/desmontaje, para facilitar la limpieza del espacio del zócalo que queda por debajo de los módulos bajos.

Encimeras de madera y laminado:

Las encimeras de madera macizas requieren un mantenimiento continuo para garantizar su resistencia a la humedad. Gamadecor dispone de un producto para tal fin, el cual viene con las instrucciones de aplicación. En caso de que este material no haya sido adquirido junto con la encimera, rogamos se dirija al distribuidor Gamadecor donde ha comprado su cocina.

Las encimeras de laminado no requieren una limpieza especial.

A pesar de sus cualidades, las encimeras de laminado y madera no son resistentes a las altas temperaturas, por lo cual, es necesario el uso de salva encimeras. Para evitar cortes en la superficie, le recomendamos usar una base, que bien puede ser de madera, granito o material sintético.

Encimeras de aglomerado de cuarzo y cristal (tipo Silestone) / Encimeras de resinas acrílicas (tipo Krion®) / Encimeras de acero / Encimeras de granito:

Para la limpieza y mantenimiento de estas encimeras, seguir las instrucciones particulares de cada fabricante.

Solicitar información al instalador de los mismos o al distribuidor de Gamadecor.

3. Medidas para evitar daños por agua

General:

No emplee las vaporetas para la limpieza de sus muebles. La presión del vapor de agua penetra en los materiales y produce una hinchazón, originando graves daños a los módulos. Mantenga secas todas las superficies, evitando derramamientos frecuentes y prolongados de alimentos líquidos, tanto fríos como calientes.

Módulos fregadero:

Se suministran de serie con una base metálica, de modo que ofrecen una máxima protección en caso de fugas de agua. Asegúrese de que los sifones están siempre bien cerrados. En caso de abrirlos para su limpieza, siempre se debe colocar un recipiente para recoger las pérdidas de agua.

Lavavajillas:

En lo posible evite que el vapor de agua que produce el lavavajillas al finalizar el ciclo de lavado, afecte a los muebles y encimera; para ello espere a que se enfríe su interior antes de abrir la puerta. (Rogamos siga las recomendaciones del fabricante del lavavajillas).

Módulos columna para integración de frigoríficos:

Se suministran de serie con base metálica para evitar filtraciones de agua durante el proceso de descongelación.

Se recomienda controlar el proceso de descongelación para evitar derrames de agua en el suelo.

Campanas extractoras:

Le recomendamos que mantenga en funcionamiento la campana extractora siempre que esté cocinando, aunque solamente sea para hervir agua. La aspiración reduce la acumulación de grasas y las condensaciones de agua en las superficies de madera, evitando el contacto directo con el agua.

Frentes de zócalo:

Los frentes de zócalo de aluminio son totalmente resistentes a la humedad y se quedan limpiar con abundante agua. Los frentes de chapado de madera con base de multicapa se deben limpiar como las demás superficies de madera, evitando el contacto directo con el agua.

Uniones/recortes/juntas a pared, en encimeras de todo tipo:

Las uniones de empalmes de las encimeras, así como los recortes en las superficies para las placas de cocción, fregadero, etc. y las juntas a pared, se deben sellar de forma totalmente impermeable durante el montaje. Esto impide, por una parte la filtración de humedad en los muebles bajos, y por otra parte la alteración de las encimeras, (especialmente las de laminado), por penetración de humedad. La mejor forma de evitar filtraciones de agua es secar siempre la encimera después de su uso y controlar periódicamente el buen estado del sellado de las juntas.

4. Condiciones ambientales

La madera es un producto natural que reacciona frente a las variaciones de temperatura y sobre todo ante la humedad ambiental, con dilataciones y contracciones. La humedad ambiental debería oscilar entre un 55%-70% y la temperatura entre 18° y 22° C. Para conseguir estas condiciones óptimas recomendamos tener ciertas precauciones:

Emplear humidificadores ambientales, o en su defecto, mantenga un recipiente con agua en cualquier sitio de la cocina, cuando esté funcionando la calefacción.

Las viviendas de nueva construcción suelen tener una humedad ambiental por encima del 70%. Aquí es imprescindible una buena ventilación.

Los climas marítimos y de montaña son los que presentan mayores diferencias en cuanto a humedad ambiental, por lo cual es preciso extremar las precauciones en estas regiones.

Como una medida adicional de conservación de la belleza de su cocina, recomendamos evitar que los rayos del sol incidan directamente sobre la madera. A pesar de la calidad de las lacas que incorporan componentes que protegen la madera contra los rayos UVA, la madera puede sufrir decoloraciones con el paso del tiempo si está expuesta de forma directa y continuada al sol.

FRA.

1. Introduction

Nous vous remercions par votre décision dans le choix de votre cuisine.

Afin de que votre cuisine reste neuve et en parfait état pendant longtemps, nous vous prions de lire ces quelques conseils pratiques pour obtenir un meilleur entretien et nettoyage.

Par son utilisation quotidienne, la cuisine est soumise à des très hauts niveaux d'exigence. Compte tenu de ceci, tous les matériaux utilisés lors de sa fabrication sont de haute qualité.

Le processus de fabrication est contrôlé dans ses différentes phases, toujours dans l'objectif de réussir un produit fiable capable de conserver ses caractéristiques d'utilisation pendant longtemps.

2. Conseils de nettoyage et entretien

Il est préférable d'effectuer des nettoyages réguliers et fréquents, plutôt que des grandes opérations de nettoyage plus profondes mais aussi moins fréquentes. Malgré les caractéristiques de haute résistance des surfaces, avec les temps, la saleté finie par s'incruster, et ceci provoque l'utilisation de produits de nettoyage beaucoup plus agressifs qui peuvent les endommager.

L'entretien des cuisines est très facile, mais il est fortement déconseillé l'emploi de certains produits et outils comme: objets pointus, chiffons rugueux, dissolvants, eau de javelle, vinaigre, acides citriques, produits abrasifs, produits qui font briller, etc.

Par leur composition, texture, finition, résistance, etc., il est nécessaire de porter quelques attentions spécifiques que nous vous énumérons:

Nettoyage:

Pour éliminer la poussière, les taches de graisse, empreintes digitales ou vapeurs dues à la cuisson, veuillez dissoudre du savon neutre dans de l'eau tiède. Nettoyer les meubles avec une éponge humide puis séchez toutes les surfaces, surtout les coins, avec un chiffon propre et sec.

Pour s'assurer que le produit est approprié pour le nettoyage, nous vous conseillons de le tester sur la partie la moins visible en sorte de vérifier les possibles altérations des couleurs ou autres possibles effets.

Les produits de nettoyage qui dégagent des vapeurs corrosives peuvent altérer la finition des parties métalliques de l'intérieur d'un meuble évier ou de nettoyage. Vérifiez que les bouchons soient toujours fermés.

Les chiffons et les éponges humides ne séchent pas facilement à l'intérieur des meubles. Leur humidité peut produire, avec le temps, des signes d'oxydation sur les matériaux de son entourage.

Surfaces laminées:

Les plus simples pour le nettoyage, ne nécessitent pas d'indications spéciales.

Surfaces en acier inoxydable:

Sur le marché vous pourrez trouver des produits spécifiques pour le nettoyage des éléments en acier, comme les façades, plaques, hautes, fours, etc. Nous vous prions de suivre les instructions des fabricants qui figurent sur leur conditionnements. Vous pourrez aussi les acquérir par moyen du distributeur Gamadecor.

Poignées avec surfaces chromées/nickel:

Pour obtenir la finition des poignées le processus suivi est celui du bain électrolytique. Pour leur nettoyage veuillez utiliser les mêmes produits que pour les laminés ou les bois.

Dans le cas de taches résistantes ou d'éraflures veuillez utiliser des produits de polissage du secteur automobile.

Filtres métalliques pour hottes:

La plus part des hottes modernes, sont équipées avec des filtres métalliques. Ils ne se changent pas, par contre ils peuvent se nettoyer dans le lave-vaisselle. La meilleure position pour leur nettoyage est la verticale. La fréquence des nettoyages dépend de son usage, mais en moyenne ils devraient se faire une fois tous les 14 jours. Nous vous prions de suivre les conseils du fabricant.

Surfaces en verre:

Utiliser les mêmes produits que pour le nettoyage des vitres.

Nettoyage des socles:

Afin de simplifier le nettoyage de l'espace des socles sous le mobilier, ils sont munis d'un système de montage et démontage très simple.

Plans de travail en bois et laminés:

Les plans de cuisine en bois massif demandent un entretien permanent pour garantir leur résistance à l'humidité. Gamadecor dispose d'un produit pour cet entretien avec ses notices d'utilisation. Si vous ne l'avez pas acquis au même moment que le plan de cuisine, nous vous prions de vous adresser chez le distributeur Gamadecor.

Les plans de cuisine laminés ne demandent pas de nettoyages spéciaux.

Malgré leurs qualités, les plans laminés ou en bois, ne résistent pas aux températures trop élevées, donc il est souhaitable d'employer des protections pour les plans. Afin d'éviter des coupures sur la surface, nous vous conseillons l'utilisation d'une planche à découper en bois, en granit ou synthétique.

Plans de travail en aggloméré de quartz et verre (type Silestone) / en résines acryliques (type Krion®) / en acier inox / en granite:

Pour le nettoyage et entretien de ces plans de travail, suivez les instructions particulières de chaque fabricant.

Demandez les instructions à l'installateur des plans de travail ou au distributeur Gamadecor.

3. Précautions afin d'éviter des possibles dégâts produits par l'eau**En générale:**

N'utilisez pas de vaporisateur pour le nettoyage de vos meubles. La pression de la vapeur d'eau pénètre dans les matériaux en produisant leur gonflement et par conséquent leur détérioration.

Conservez sèches toutes les surfaces, en évitant les renversements fréquents d'aliments liquides, froids ou chauds.

Modules à évier:

De série, ils sont fournis avec une base métallique, en offrant un maximum de protection en cas de fuites d'eau. Assurez-vous que les siphons soient toujours fermés. Si vous les ouvrez pour leur nettoyage prenez toujours la précaution de positionner dessous un récipient pour récupérer l'eau qui pourra se renverser.

Lave-vaisselle:

Eviter que la vapeur d'eau dégagée par le lave-vaisselle puis endommager les meubles et aussi au plan de cuisine. Comme précaution attendez le refroidissement du lave-vaisselle avant de l'ouvrir. Veuillez suivre les recommandations du fabricant du lave-vaisselle.

Modules pour intégration des réfrigérateurs

De série, ils se fournissent avec une base métallique afin d'éviter les infiltrations d'eau pendant le processus de décongélation.

Nous conseillons de contrôler le processus de décongélation pour éviter des fuites d'eau sur le sol.

Hottes:

Nous vous conseillons de mettre en fonctionnement la hotte chaque fois que vous cuisinez, même si il s'agit uniquement de faire bouillir de l'eau. L'aspiration réduit l'accumulation de graisses et les condensations d'eau sur les surfaces de votre cuisine.

Façades de socles:

Les façades de socles en aluminium résistent parfaitement à l'humidité et peuvent être nettoyés avec de l'eau abondante. Les façades de socles plaqués en bois avec une base multistrat, doivent être nettoyés comme les autres surfaces en bois, en évitant le contact direct avec l'eau.

Assemblages / Découpes / joints au mur, sur tous types de plans:

Les assemblages de plans de cuisines, ainsi comme les coupes des surfaces pour le positionnement de plaques à cuisson, éviers, etc. Et les joints au mur, doivent se monter de telle sorte qu'ils soient complètement imperméables. Nous éviterons d'une part, la pénétration de l'humidité dans les meubles bas et d'une autre l'altération des plans de cuisine (surtout les laminés) par pénétration de l'humidité. Le meilleur système pour éviter les infiltrations est celui de sécher après chaque usage le plan de cuisine et contrôler régulièrement l'état des joints.

4. Conditions d'environnement

Le bois est un produit naturel lequel réagit par rapport aux variations de températures et surtout par l'humidité de l'environnement avec les dilatations et les contractions. L'humidité de l'environnement devrait varier entre 55%-70% et la température entre 18°-22° C. Pour atteindre ces conditions optimales nous conseillons quelques précautions:

Utiliser des humidificateurs d'ambiance ou bien un récipient avec de l'eau dans la cuisine, pendant le fonctionnement du chauffage.

Les nouvelles constructions tournent habituellement avec une humidité d'environnement au dessus de 70%. Dans ce cas il est incontournable d'avoir une bonne ventilation.

Les climats maritimes et de montagne présentent les plus grandes différences concernant l'humidité d'environnement, ceci dit les précautions doivent être encore plus importantes.

Comme mesure supplémentaire et pour la conservation de la beauté de votre cuisine, nous vous conseillons d'éviter que les rayons solaires tapent directement sur le bois. Malgré la qualité des laques qui incorporent des composants pour les protéger, le bois peut subir des décolorations avec le passage du temps et une exposition permanente et directe au soleil.

ENG.

Unless expressly stated otherwise in writing, the following conditions shall apply to all our sales:

PRICES: The prices of the products shown in the price list do not include V.A.T. They are given a rating whose value will be notified separately.

The prices of the list in effect cannot be guaranteed for orders with a requested delivery time of more than 6 months.

The packing is included in the price. Additional packing can be furnished upon the client's request. In which case, GAMADECOR, S.A. reserves the right to charge a supplement.

The prices are subject to changes at the will of GAMADECOR, S.A. Those changes shall be notified to the clients prior to the shipping of goods.

ORDERS: All orders shall be revised by GAMADECOR, S.A. and confirmed by the client. Any addition or modification to a previously confirmed order, will be considered as a new order as regards the conditions of sale and the delivery time.

No special elements or items shall be returned or replaced. In the case of a cancellation or modification of an order, GAMADECOR, S.A. reserves the right to invoice the costs arising out of such cancellation or modification.

DELIVERY: Delivery time shall only be given as an approximation. No damages can be claimed for late delivery.

All goods shall be delivered under "EXW" (on a lorry in our Villarreal premises), thus, they shall be considered received and accepted on the vehicle and they shall be shipped by order and on account and risk of the buyer.

RESERVATION OF TITLE: Goods shall remain the property of GAMADECOR, S.A. and considered as a deposit until full payment of the purchase price, in compliance with the provisions of Article 1766 and following of the Commercial Code.

PAYMENT: Promisory note or transfer 60 days after invoice date for the net sum. Default in payment will give GAMADECOR, S.A. the right to charge the default bank interests calculated according to the then actual rate plus 5 points, and/or the return costs.

CLAIMS: Claims of any type shall only be dealt with when made in writing within 8 days after receipt of goods. Such goods, as stated in paragraph "DELIVERY", shall be shipped on account and risk of the buyer. Therefore, no claims shall be accepted for breakage during transportation. Any breakage for this reason must be conveyed to the carrier, since all goods are shipped duly checked.

The shade of colours may vary from one delivery to another. Thus, no claims shall be accepted for this reason. The shade and colour of products made of natural stone or solid wood may vary a lot from one delivery to another because of their natural quality; in such case, no claims shall be accepted either.

No claims can be accepted for the following reasons:

- Damage caused by wrong use or installation.
- Changes in the colour shades after a long exposition to the sunlight.

RETURNS: Since the kitchen material is made on order, no return of goods shall be admitted, except for items considered "standard equipment", which are complementary to a kitchen.

All returns must be notified in writing to GAMADECOR, S.A., and a prior authorisation of the company shall be needed. Furthermore, a previous agreement between GAMADECOR, S.A., and the buyer shall be necessary to decide about the means of transport to be used.

It shall be *conditio sine qua non*, for acceptance of a return, that the goods as well as the packing be in a perfect condition. However, such return shall be refunded at the purchase price minus 25% to cover handling, verification and depreciation of the goods.

LIABILITY: Liability for possible accidents to the goods or persons due to handling, assembling or wrong use of our items is refused.

GAMADECOR, S.A. reserves the right to make changes in colour, structure, etc. of its items without notice or obligation when considered necessary to improve the quality thereof.

PLACE OF JURISDICTION: For all disputes arising out of the purchase and sale, the parties agree hereby to waive the jurisdiction of their domicile and they shall be subject to the jurisdiction of Castellón de la Plana.

ESP.

Salvo estipulación escrita en contrario, para todas nuestras ventas, regirán las siguientes condiciones:

PRECIOS: Se informa que los precios de los productos indicados en la presente tarifa no contemplan I.V.A. Están expresados en puntos; el valor de cada uno será comunicado por separado.

Los precios de la tarifa en vigor no pueden garantizarse sobre pedidos cuyas fechas de entrega solicitadas excedan de 6 meses.

El embalaje está incluido en el precio. Puede proveerse un embalaje suplementario previa solicitud del cliente, en cuyo caso GAMADECOR, S.A. se reserva el derecho de aplicar un suplemento.

Los precios son susceptibles de modificación a criterio de GAMADECOR, S.A. Estas variaciones se comunicarán a los clientes con anterioridad a la expedición de las mercancías.

PEDIDOS: Todos los pedidos serán revisados por GAMADECOR, S.A. y confirmados por el cliente. Todo añadido o modificación a un pedido confirmado previamente, será contemplado como un nuevo pedido tanto desde el punto de vista de las condiciones de venta como de los plazos de entrega.

Ningún elemento o artículo especial será objeto de devolución o cambio. En caso de anulación o modificación de un pedido, GAMADECOR, S.A. se reserva el derecho de facturar los gastos generados por esta anulación o modificación.

ENTREGAS: Los plazos de entrega se darán solamente a título indicativo. Ninguna indemnización puede reclamarse por causa de retraso.

Toda entrega de mercancía será realizada en condiciones "EX FABRICA" (sobre camión en nuestros almacenes de Villarreal), por tanto, se considerarán como recibidas y aceptadas sobre vehículo, expidiéndose por orden, cuenta y riesgo del comprador.

RESERVA DE PROPIEDAD: La mercancía queda en propiedad de GAMADECOR, S.A. hasta la completa satisfacción del precio de compra, considerándose en depósito hasta ese momento; rigiéndose por lo establecido en el Art. 1766 y siguientes del Código de Comercio.

FORMAS DE PAGO: Pagaré o transferencia a 60 días fecha factura por el importe neto de las mismas. El incumplimiento de las fechas de pago dará derecho a GAMADECOR, S.A. a adecuar los intereses bancarios de demora, calculados y de acuerdo al interés oficial del momento, aumentado en 5 puntos y/o los gastos de devolución.

RECLAMACIONES: Las reclamaciones de cualquier tipo sólo se estudiarán si son efectuadas por escrito dentro de los 8 días siguientes a la recepción de la mercancía. Esta, según se detalla en el apartado "ENTREGA" viaja por cuenta y riesgo del comprador, por lo tanto no serán admitidas reclamaciones de roturas por causa del transporte. Cualquier rotura por este motivo deberá ser cursada al transportista, dado que todas las mercancías se expiden debidamente comprobadas.

La tonalidad de los colores puede variar de una entrega a otra, por lo tanto no se admitirán reclamaciones por este motivo. La tonalidad y color de las piezas realizadas con piedras naturales o maderas, dado que se trata de productos naturales, puede variar sustancialmente de una entrega a otra; en este caso tampoco se aceptarán reclamaciones.

No pueden tomarse en consideración para posibles reclamaciones:

- El deterioro debido a una mala utilización o a una colocación incorrecta.
- Los cambios de tono debido a una exposición prolongada a la luz del sol.

DEVOLUCIONES: Dado que el material de cocinas se fabrica contra pedido, no se admitirá ninguna devolución de material, salvo aquellos artículos de "equipamiento standard", que son complementarios a una cocina.

Toda devolución deberá ser notificada por escrito a GAMADDECOR, S.A., y autorizada por ésta, previamente a su ejecución. Así mismo, será necesario un acuerdo previo entre GAMADDECOR, S.A., y el cliente para determinar el medio de transporte que deberá utilizarse.

Será requisito imprescindible para admitir cualquier devolución que, tanto la mercancía como el embalaje se encuentren en perfecto estado. No obstante dicha devolución será abonada al precio de compra menos un 25% en concepto de manipulación, verificación y depreciación de la mercancía.

RESPONSABILIDADES: Se declina cualquier responsabilidad por posibles accidentes a las cosas o personas que puedan ocurrir a causa de manipulación, montaje o incorrecta utilización de nuestros artículos.

GAMADDECOR, S.A. se reserva el derecho a realizar las modificaciones en colores, estructuras, etc. de nuestros artículos sin previo aviso, siempre que las considere necesarias para mejorar la calidad de los mismos.

COMPETENCIAS: Para cualquier cuestión derivada de la compraventa, las partes hacen renuncia a su fuero propio, sometiéndose al de los juzgados y tribunales de Castellón de la Plana.

FRA.

Sauf stipulation écrite contraire, toutes nos ventes seront régies par les conditions suivantes :

PRIX : Les prix des produits indiqués sur le présent tarif ne comprennent pas la T.V.A. Ils sont exprimés en points ; la valeur de chaque point sera communiquée à part.

Les prix indiqués sur le tarif en vigueur ne peuvent être garantis sur des commandes dont les dates de livraison exigées dépassent 6 mois. L'emballage est inclus dans le prix. Un emballage supplémentaire peut être fourni sur demande préalable du client, dans ce cas, GAMADDECOR, S.A. se réserve le droit d'appliquer un supplément.

Le prix sont susceptibles de modification à critère de GAMADDECOR, S.A. Ces variations seront communiquées à l'avance, aux clients, avant l'expédition des marchandises.

COMMANDES : Toutes les commandes seront révisées par GAMADDECOR, S.A. et confirmées par le client. Toute addition ou modification à une commande confirmée antérieurement, sera considérée comme une nouvelle commande, aussi bien du point de vue des conditions de vente que des délais de livraison.

Aucun élément ou article spécial sera l'objet de renvoi ou d'échange. En cas d'annulation ou de modification d'une commande, GAMADDECOR, S.A. se réserve le droit de facturer les frais occasionnés par cette annulation ou modification.

LIVRAISON : Les délais de livraison seront seulement donnés à titre indicatif. Aucune indemnisation ne pourra être réclamée pour cause de retard.

Toute livraison de marchandises sera réalisée aux conditions EXW (sur camion, dans nos entrepôts de Villarreal), par conséquent, elles seront considérées comme reçues et acceptées sur véhicule, étant expédiées sur ordre, à la charge et aux risques et périls de l'acheteur.

RÉSERVE DE PROPRIÉTÉ : Les marchandises demeurent la propriété de GAMADDECOR, S.A. jusqu'à l'acquit complet du montant de l'achat et sont considérées en dépôt jusqu'à ce moment, en vertu de l'Article 1766 et suivants du Code de Commerce.

PAIEMENT : Virement bancaire à 60 jours date facture par le montant net de celle-ci. Le non-respect des dates de paiement donnera le droit à GAMADDECOR, S.A. d'exiger les intérêts bancaires relatifs au retard, calculés et en accord avec les taux d'intérêt officiel du moment, augmenté de 5 points et/ou les frais de renvoi.

RÉCLAMATIONS : Les réclamations, quelles qu'elles soient, seront prises en considération si elles sont effectuées par écrit dans les huit jours suivant la réception de la marchandise.

Celle-ci, comme il est stipulé dans le paragraphe « LIVRAISON », voyage aux frais et aux risques et périls de l'acheteur ; par conséquent, les réclamations pour casse à cause du transport ne seront pas admises.

Toute casse pour ce motif se règlera avec le transporteur, étant donné que toutes nos marchandises sont dûment vérifiées avant l'envoi. La tonalité des couleurs peut varier d'une livraison à l'autre, donc aucune réclamation ne sera admise pour ce motif. La tonalité et la couleur des pièces manufacturées avec des pierres naturelles ou du bois peuvent varier beaucoup d'une livraison à l'autre, puisqu'il s'agit de matériaux naturels ; dans ce cas, aucune réclamation ne sera acceptée non plus.

Ne peuvent se prendre en considération pour des possibles réclamations :

- La détérioration due à une mauvaise utilisation ou une pose incorrecte.
- Les changements de tonalité résultant d'une exposition prolongée à la lumière du soleil.

RENOIS : Étant donné que les éléments de cuisine se fabriquent sur demande, aucun renvoi desdits éléments ne sera admis, sauf pour les articles « d'équipement standard » qui sont complémentaires à une cuisine.











Tout renvoi devra être notifié par écrit à GAMADDECOR, S.A. et autorisé par cette dernière avant de procéder à son exécution. De la même manière, un accord préalable entre GAMADDECOR, S.A. et son client sera nécessaire pour déterminer le moyen de transport qui devra être utilisé.

Il est indispensable pour admettre tout renvoi que la marchandise ainsi que l'emballage soient en parfait état. Néanmoins, ledit renvoi sera remboursé au prix d'achat moins 25 % à titre de manipulation, vérification et dépréciation de la marchandise.

RESPONSABILITÉS : Toute responsabilité est déclinée quant aux accidents pouvant survenir aux personnes ou aux biens résultant de la manipulation, montage ou utilisation incorrecte de nos articles.

GAMADDECOR, S.A. se réserve le droit de faire toutes modifications de couleurs, structures, etc. de ses articles chaque fois qu'elles seront nécessaires à l'amélioration de la qualité de ceux-ci.

ATTRIBUTION DE COMPÉTENCES : Pour tout litige découlant du contrat d'achat-vente, les parties renoncent à leur propre juridiction et se soumettent à la juridiction des Tribunaux de Castellón de la Plana.

Icon Icono Icône	Description Descripción Description
	The unit supports the front handle El módulo admite tirador frontal Le module prend en charge poignée en façade
	The model supports the "push" system. El modelo permite incorporar el sistema tipo "push". Le modèle prend en charge le système "push".
	The unit supports 60° mitered-mechanized handle in the door edge. El módulo permite incorporar tirador mecanizado a 60° en el canto del frente. Le module prend en charge le poignée usiné coupe en 60° dans le chant de la façade.
	The unit supports integrated aluminium door handle in the door edge. El módulo permite incorporar tirador de aluminio integrado en la puerta. Le module prend en charge le poignée en aluminium intégrée dans le chant de la porte.
	The model supports integrated door handle in the upper part of the door. El modelo permite incorporar tirador integrado en la parte superior. Le modèle prend en charge le poignée intégrée dans le chant supérieur de la porte.
	The wall unit supports the front 2 cm longer than the carcass. El módulo alto permite incorporar el frente de 2 cm más largo que el casco. Le module haut prend en charge la façade 2 cm plus long que le caisson.
	The crossed out symbol indicates that it is NOT allowed. El aspa indica que NO se permite. Le croix signifie que cela n'est pas permis.
	The round symbol indicates that it is NOT allowed in the marked widths. El círculo indica que NO se permite en los anchos señalados. Le cercle signifie que les largeurs indiquées ne sont pas permises.
	Measurement between drill centres for handles (mm). Medida entre centros de los taladros para tiradores (mm). Mesure des entraxes des poignées (mm).
	The unit is delivered unassembled with eccentric fitting. El módulo se suministra desmontado con excéntricas. Le module est livré démonté avec excentriques.

1 - Laminate, group 1 / Laminado, grupo 1
/ Mélangine, group 1.

3 - Laminate, group 2 / Laminado, grupo 2
/ Mélangine, group 2.

4 - High pressure laminate (HPL) / Estratificado (HPL)
/ Stratifié (HPL).

The first number indicates the kind of finish.
El primer dígito indica el tipo de acabado.
Le premier chiffre indique le type de finition.

R 1.60

The second number indicates the kind of handle.
El segundo número indica el tipo de tirador.
Le second chiffre indique le type de poignée.

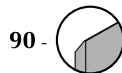
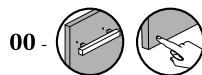

02

models, finishes, handles
modelos, acabados, tiradores
modèles, finitions, poignées

Models and finishes

- p.38** Laminate finishes, group R1
Laminados, grupo R1
Mélaminés, group R1
- p.40** Laminate finishes, group R1
Laminados, grupo R1
Mélaminés, group R1
- p.42** High pressure laminate (HPL)
Estratificado (HPL)
Stratifié (HPL)

Handles

- p.44** Handles
Tiradores
Poignées



Laminate finishes.

Flat surface with laminate finish in both faces.
Four ABS edged pieces the same colour as the front. Joined to the edge by PUR glue. Particleboard substrate.

Laminados.

Superficie lisa con laminado a dos caras. Cuatro cantos de ABS de igual color que el frente, unido mediante cola PUR. Base tablero aglomerado.

Mélaminés.

Surface lisse mélaminé sur les deux faces. Quatre chants en ABS couleur façade, appliqué au moyen colle PUR. Base panneau aggloméré.

**Wood imitation.
Imitación madera.
Imitation bois.**



1163
Eucalyptus Blond



1164
Eucalyptus Gray



1166
Eucalyptus Candy



1165
Eucalyptus Smutty



1167
Etimoie Ice



1168
Etimoie Land



1169
Etimoie Night



0460
Roble Orgánico



0461
Roble Tierra



0462
Roble Arenado



0463
Roble Pardo



0464
Roble Negro

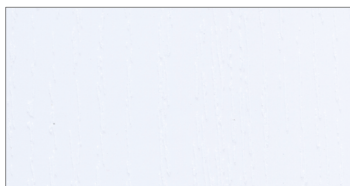

0449
Blanco Orgánico

**Plain colours.
Colores lisos.
Couleurs lisses.**

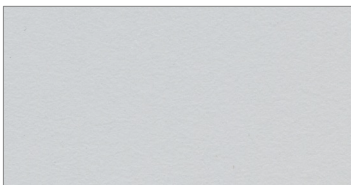

1171
Niebla

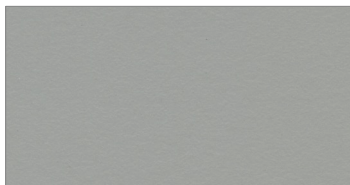

1172
Zinc

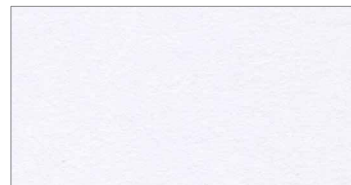

1198
Blanco Núbol

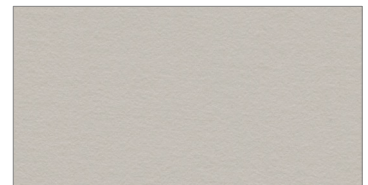

1199
Bisón

*The colors can be different from the original ones. / Los colores pueden presentar diferencias respecto a los originales. / Les couleurs peuvent être différentes par rapport à celles d'origine.

R1.00
PUR edge. **01**

Door thickness, 19 mm.
Request door handle separately.
See available handles on handles section.



Espesor de puerta de 19 mm.
Solicitar tirador por separado.
Ver tiradores disponibles en el apartado de tiradores.



Épaisseur de porte, 19 mm.
Demander des poignée séparément.
Voir poignées disponibles sur la section de poignées.

R1.60
PUR edge. **04**

Door thickness, 19 mm.
Integrated aluminium door handle in the door edge.



Espesor de puerta de 19 mm.
Tirador de aluminio integrado en la puerta.

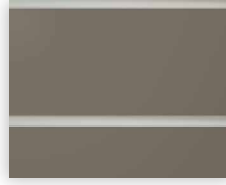

Épaisseur de porte, 19 mm.
Poignée en aluminium intégrée dans le chant de la porte.

R1.70
PUR edge. **04**

Door thickness, 19 mm.
Integrated door handle in the upper part of the door.



Espesor de puerta de 19 mm.
Tirador integrado en la parte superior.



Épaisseur de porte, 19 mm.
Poignée intégrée dans le chant supérieur de la porte.

R1.90
PUR edge. **04**

Door thickness, 19 mm.
60° mitered-mechanized handle in the door edge.
This model requires Horizontal spacer between units.



Espesor de puerta de 19 mm.
Tirador mecanizado a 60° en el canto del frente.
Este modelo requiere separador horizontal entre módulos.

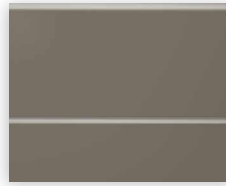

Épaisseur de porte, 19 mm.
Poignée usiné coupe en 60° dans le chant de la façade.
Ce modèle nécessite séparateur horizontal entre modules.



Laminate finishes.
 Flat surface with laminate finish in both faces.
 Four PP edged pieces the same colour as the front. Joined to the edge by laser melting.
 MDF substrate.

Laminados.
 Superficie lisa con laminado a dos caras.
 Cuatro cantos de PP de igual color que el frente, unido con tecnología láser.
 Base tablero MDF.

Mèlaminés.
 Surface lisse mèlaminé sur les deux faces.
 Quatre chants en PP couleur façade, appliqué au moyen technologie de laser.
 Base panneau MDF.

Plain colours.
Colores lisos.
Couleurs lisses.

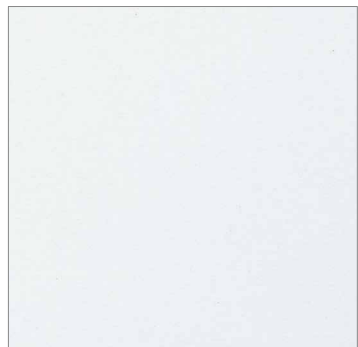

0444
 Blanco Snow

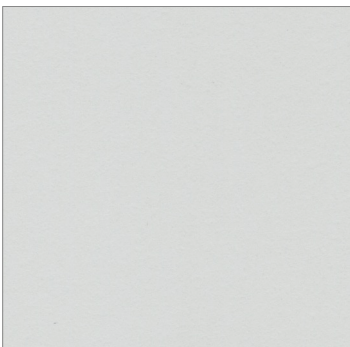

1173
 Gris Hook mate



0441
 Cement mate



0421
 Storm mate



0443
 Mouse mate



1197
 Topo mate

**The colors can be different from the original ones. / Los colores pueden presentar diferencias respecto a los originales. / Les couleurs peuvent être différentes par rapport à celles d'origine.*

R3.00 03
Laser edge.

Door thickness, 19 mm.
Request door handle separately.
See available handles on handles section.



Espesor de puerta de 19 mm.
Solicitar tirador por separado.
Ver tiradores disponibles en el apartado de tiradores.

Épaisseur de porte, 19 mm.
Demander des poignée séparément.
Voir poignées disponibles sur la section de poignées.



R3.60 05
Laser edge

Door thickness, 19 mm.
Integrated aluminium door handle in the door edge.



Espesor de puerta de 19 mm.
Tirador de aluminio integrado en la puerta.

Épaisseur de porte, 19 mm.
Poignée en aluminium intégrée dans le chant de la porte.

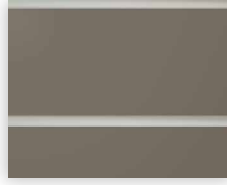

R3.70 05
Laser edge

Door thickness, 19 mm.
Integrated door handle in the upper part of the door.



Espesor de puerta de 19 mm.
Tirador integrado en la parte superior.

Épaisseur de porte, 19 mm.
Poignée intégrée dans le chant supérieur de la porte.



R3.90 05
Laser edge

Door thickness, 19 mm.
60° mitered-mechanized handle in the door edge.
This model requires Horizontal spacer between units.



Espesor de puerta de 19 mm.
Tirador mecanizado a 60° en el canto del frente.
Este modelo requiere separador horizontal entre módulos.

Épaisseur de porte, 19 mm.
Poignée usiné coupe en 60° dans le chant de la façade.
Ce modèle nécessite séparateur horizontal entre modules.

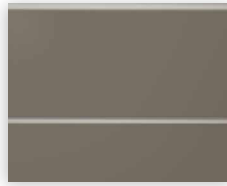

models, finishes, handles
 modelos, acabados, tiradores
 modèles, finitions, poignées

High pressure laminate (HPL)
 Estratificado (HPL)
 Stratifié (HPL)

Finishes
 Acabados
 finitions



High pressure laminate (HPL).
 Flat surface with high pressure laminate (HPL) finish in both faces.
 Four PP edged pieces the same colour as the front. Joined to the edge by laser melting.
 Particleboard substrate.

Estratificado (HPL).
 Superficie lisa con estratificado (HPL) a dos caras.
 Cuatro cantos de PP de igual color que el frente, unido con tecnología láser.
 Base tablero aglomerado.

Stratifié (HPL).
 Surface lisse stratifié (HPL) sur les deux faces.
 Quatre chants en PP couleur façade, appliqué au moyen technologie de laser.
 Base panneau aggloméré.

Plain colours.
 Colores lisos.
 Couleurs lisses.

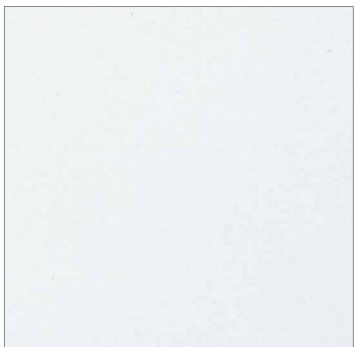

0440
 Blanco Sal

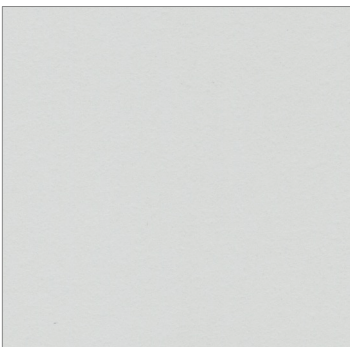

1196
 Gris Hook brillo



0438
 Cemento brillo



0419
 Storm brillo



0439
 Mouse brillo



1174
 Topo brillo

**The colors can be different from the original ones. / Los colores pueden presentar diferencias respecto a los originales. / Les couleurs peuvent être différentes par rapport à celles d'origine.*

R4.00 05
Laser edge.

Door thickness, 19 mm.
Request door handle separately.
See available handles on handles section.



Espesor de puerta de 19 mm.
Solicitar tirador por separado.
Ver tiradores disponibles en el apartado de tiradores.

Épaisseur de porte, 19 mm.
Demander des poignée séparément.
Voir poignées disponibles sur la section de poignées.



R4.60 07
Laser edge

Door thickness, 19 mm.
Integrated aluminium door handle in the door edge.



Espesor de puerta de 19 mm.
Tirador de aluminio integrado en la puerta.

Épaisseur de porte, 19 mm.
Poignée en aluminium intégrée dans le chant de la porte.

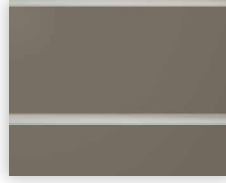

Indications for handles.

Indicaciones para tiradores.

Indications pour les poignées.



Position of handle: Vertical.
Posición del tirador: Vertical.
Position de poignée: Verticale.



Position of handle: Horizontal.
Posición del tirador: Horizontal.
Position de poignée: Horizontale.

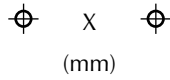

Distance between drill centers.
Distancia entre centros de los taladros.
Distance entre les centres des perceuses.

(mm)

Wharf handle.

Aluminium handle, satainless steel finish.
It is recommended do not face two handles
in vertical position for units with double
door.

Tirador Wharf.

Tirador de aluminio, acabado inox.
NOTA: Se recomienda no enfrenar dos
tiradores en posición vertical para módulos
de doble puerta.

Poignée Wharf.

Poignée en aluminium, finition inox.
Il est recommandé de ne pas faire face à
deux poignées en position verticale pour
les unités avec double porte.



SAP	Code Código Code	Width Ancho Largeur	Points Puntos Points
100213110	TR 1036	20	18

Handle.

Stainless steel colour.
*Only available for units with integrated
refrigerator.

Tirador.

Color acero inoxidable.
*Sólo disponible para módulos con frigorí-
fico integrado.

Poignée.

Couleur acier inox.
*Disponible seulement pour modules avec
réfrigérateur intégré.

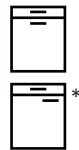

160
(mm)

SAP	Code Código Code	Width Ancho Largeur	Points Puntos Points
100213120	TR 1037	20	30

Popper handle.

Stainless steel colour.

Tirador Popper.

Color acero inoxidable.

Poignée Popper.

Couleur acier inox.



192
(mm)

SAP	Code Código Code	Width Ancho Largeur	Points Puntos Points
100213111	TR 1038	20,6	24

models, finishes, handles
modelos, acabados, tiradores
modèles, finitions, poignées

Handles
Tiradores
Poignées

Popper bar handle.
Matt black colour.

Tirador de barra Popper.
Color negro mate.

Poignée de barre Popper.
Couleur Noir mat.

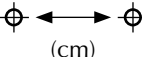

Unit width Ancho módulo Largeur module	Handle width Ancho tirador Largeur poignée	 (cm)
15	7,7	6,3
30	22,7	21,3
38,1	30,8	29,4
40	32,7	31,3
45	37,7	36,3
50	42,7	41,3
60	52,7	51,3
76	68,9	67,5
80	72,7	71,3
90	82,7	81,3
91,5	84,2	82,8
100	92,7	91,3
120	112,7	111,3

SAP	Code Código Code	Unit width Ancho módulo Largeur module	Points Puntos Points
100213121	TR 1040	15	20
100213088	TR 1040	30	30
100213122	TR 1040	38,1	35
100213112	TR 1040	40	37
100213101	TR 1040	45	41
100213079	TR 1040	50	45
100213038	TR 1040	60	54
100213048	TR 1040	76	67
100213100	TR 1040	80	72
100213049	TR 1040	90	74
100213087	TR 1040	91,5	76
100213039	TR 1040	100	83
100213093	TR 1040	120	98

"Push" handle.
Maximum door height, 150 cm.
Maximum drawer front height, 42 cm.
Maximum drawer front width, 90 cm.

Tirador "push".
Altura máxima de puerta, 150 cm.
Altura máxima de frente de cajón, 42 cm.
Anchura máxima de frente de cajón, 90 cm

Poignée "push".
Hauteur maximum de porte de 150 cm.
Hauteur maximum de tiroir de 42 cm.
Largeur maximum de tiroir de 90 cm.



SAP	Code Código Code	Width Ancho Largeur	Points Puntos Points
100213092	TR 1039	-	13

03

Base units
Módulos bajos
Modules bas

Units / Módulos / Modules

p.48	H.18
p.50	H.42
p.52	H.60
p.64	H.78

Complements / Complementos / Compléments

p.80	Complements for base unit Complementos para módulo bajo Compléments pour module bas
------	---

h. 18

Base units
Módulos bajos
Modules bas

Base units
Módulos bajos
Modules Bas

Base unit with drawers
Módulo bajo con cajones
Module bas avec tiroirs

H. 18

Base unit with drawer.
1 drawer.

Módulo bajo con cajón.
1 cajón.

Modules bas avec tiroir.
1 tiroir.

Availability / disponibilidad / disponibilité:

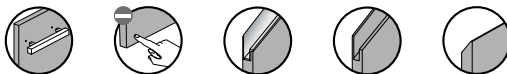
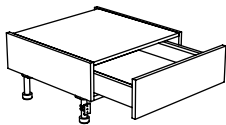

61 depth / profundidad / profondeur

SAP	Code Código Code	Width Ancho Largeur	Opening Apertura Ouverture											
				0	1	2	3	4	5	6	7	8	9	10
700020331	BC 0001	30	-	400	414	-	453	486	501	-	526	-	-	-
700020332	BC 0001	40	-	410	424	-	465	498	514	-	540	-	-	-
700020333	BC 0001	45	-	414	429	-	471	505	520	-	547	-	-	-
700020334	BC 0001	50	-	419	434	-	477	511	526	-	554	-	-	-
700020335	BC 0001	60	-	435	452	-	497	533	550	-	581	-	-	-
700020336	BC 0001	76,2	-	454	471	-	520	561	573	-	608	-	-	-
700020337	BC 0001	80	-	457	475	-	524	563	578	-	613	-	-	-
700020338	BC 0001	90	-	472	490	-	541	581	595	-	633	-	-	-
700020339	BC 0001	⊖ 100	-	481	501	-	553	595	613	-	648	-	-	-
700020360	BC 0001	⊖ 120	-	511	532	-	589	633	650	-	689	-	-	-

45 depth / profundidad / profondeur

SAP	Code Código Code	Width Ancho Largeur	Opening Apertura Ouverture											
				0	1	2	3	4	5	6	7	8	9	10
700020361	BC 0002	30	-	397	410	-	450	482	497	-	521	-	-	-
700020362	BC 0002	40	-	405	420	-	461	494	509	-	535	-	-	-
700020363	BC 0002	45	-	409	424	-	466	500	515	-	542	-	-	-
700020364	BC 0002	50	-	413	429	-	471	505	520	-	548	-	-	-
700020365	BC 0002	60	-	421	439	-	483	519	535	-	566	-	-	-
700020366	BC 0002	76,2	-	442	460	-	507	548	561	-	595	-	-	-
700020367	BC 0002	80	-	445	464	-	511	550	565	-	600	-	-	-
700020368	BC 0002	90	-	460	480	-	530	569	583	-	621	-	-	-
700020369	BC 0002	⊖ 100	-	468	488	-	540	582	594	-	634	-	-	-
700020370	BC 0002	⊖ 120	-	490	511	-	566	610	621	-	665	-	-	-

h. 42

Base units
Módulos bajos
Modules bas

Base units
Módulos bajos
Modules Bas

Base unit with drawers
Módulo bajo con cajones
Module bas avec tiroirs

H. 42

Base unit with drawer.
1 deep drawer.

Módulo bajo con cajón.
1 gaveta.

Modules bas avec tiroir.
1 extractible.

Availability / disponibilidad / disponibilité:

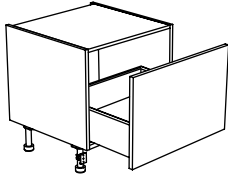
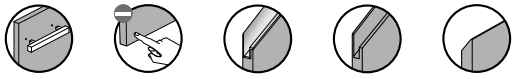

61 depth / profundidad / profondeur





SAP	Code Código Code	Width Ancho Largeur	Opening Apertura Ouverture	0	1	2	3	4	5	6	7	8	9	10
				700020371	BE 0003	30	-	460	476	-	525	556	573	-
700020372	BE 0003	40	-	469	488	-	539	570	592	-	625	-	-	-
700020373	BE 0003	45	-	474	493	-	546	577	599	-	634	-	-	-
700020374	BE 0003	50	-	479	499	-	553	584	607	-	643	-	-	-
700020375	BE 0003	60	-	495	517	-	574	605	628	-	669	-	-	-
700020376	BE 0003	76,2	-	514	542	-	604	638	663	-	712	-	-	-
700020377	BE 0003	80	-	520	549	-	612	644	671	-	721	-	-	-
700020378	BE 0003	90	-	535	565	-	631	664	691	-	739	-	-	-
700020379	BE 0003	⊖ 100	-	544	576	-	645	679	706	-	758	-	-	-
700020380	BE 0003	⊖ 120	-	575	610	-	686	720	747	-	800	-	-	-

45 depth / profundidad / profondeur

SAP	Code Código Code	Width Ancho Largeur	Opening Apertura Ouverture	0	1	2	3	4	5	6	7	8	9	10
				700020381	BE 0004	30	-	458	474	-	522	554	571	-
700020382	BE 0004	40	-	467	485	-	536	567	589	-	622	-	-	-
700020383	BE 0004	45	-	471	490	-	542	573	596	-	630	-	-	-
700020384	BE 0004	50	-	475	495	-	548	580	602	-	639	-	-	-
700020385	BE 0004	60	-	483	505	-	561	592	615	-	656	-	-	-
700020386	BE 0004	76,2	-	504	532	-	593	627	652	-	700	-	-	-
700020387	BE 0004	80	-	509	538	-	600	633	660	-	703	-	-	-
700020388	BE 0004	90	-	525	556	-	621	654	681	-	728	-	-	-
700020389	BE 0004	⊖ 100	-	533	566	-	634	668	694	-	746	-	-	-
700020390	BE 0004	⊖ 120	-	555	591	-	665	699	726	-	778	-	-	-

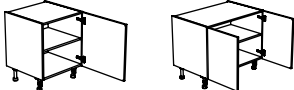
h. 60

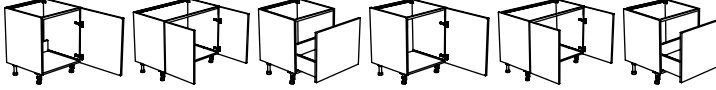
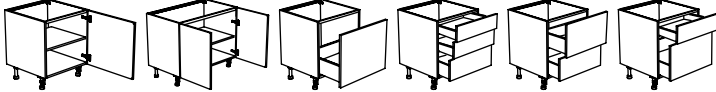
Base units
Módulos bajos
Modules bas

Type of unit Tipo de módulo Type de module	Available measures Medidas disponibles Dimensions disponibles	Available units Módulos disponibles Modules disponibles
<p>p.54</p> <p>Base unit with door Módulo bajo con puerta Module bas avec porte</p>	<p>Depth / Profundidad / Profondeur (cm.): 35 - 45 - 61</p> <p>Width / Ancho / Largeur (cm.): 30 - 40 - 45 - 50 - 60 (1 door) 76,2 - 80 - 90 - 100 - 120 (2 doors)</p>	 <p>BP 0005 - 0006 - 0007</p> <p>BP 0008 - 0009 - 0010</p>
<p>p.55</p> <p>Base corner unit Módulo bajo rinconero Module bas encoignure</p>	<p>Depth / Profundidad / Profondeur (cm.): 61</p> <p>Door width / Ancho puerta / Largeur porte: 30 - 40 - 45 - 50 - 60</p>	 <p>BRR 0011</p>
<p>p.56 - 58</p> <p>Base unit with drawers Módulo bajo con cajones Module bas avec tiroirs</p>	<p>Depth / Profundidad / Profondeur (cm.): 45 - 61</p> <p>Width / Ancho / Largeur (cm.): 30 - 40 - 45 - 50 - 60 - 76,2 - 80 - 90 - 100 - 120</p>	 <p>BE 0012 - 0013</p> <p>BE 0014 - 0015</p> <p>BE 0016 - 0017</p> <p>BE 0018 - 0019</p> <p>BCE 0020 - 0021</p>
<p>p.59 - 60</p> <p>Base sink unit Módulo bajo fregadero Module bas évier</p>	<p>Depth / Profundidad / Profondeur (cm.): 61</p> <p>Width / Ancho / Largeur (cm.): 40 - 45 - 50 - 60 (1 door) 76,2 - 80 - 90 - 100 - 120 (2 doors)</p>	 <p>BF 0022</p> <p>BF 0023</p> <p>BF 0024</p> <p>BF 0067 (USA)</p> <p>BF 0068 (USA)</p> <p>BF 0069 (USA)</p>
<p>p.61 - 63</p> <p>Base unit for hob Módulo bajo para placa de cocción Module bas pour plaque de cuisson</p>	<p>Depth / Profundidad / Profondeur (cm.): 61</p> <p>Width / Ancho / Largeur (cm.): 40 - 45 - 50 - 60 (1 door) 76,2 - 80 - 90 - 100 - 120 (2 doors)</p>	 <p>BPL 0025</p> <p>BPL 0026</p> <p>BPL 0027</p> <p>BPL 0028</p> <p>BPL 0029</p> <p>BPL 0030</p>
<p>p.63</p> <p>Base unit for hob and oven Módulo bajo para placa y horno Module bas pour plaque et four</p>	<p>Depth / Profundidad / Profondeur (cm.): 61</p> <p>Width / Ancho / Largeur (cm.): 60 - 76,2 - 90</p>	 <p>BPL 0031</p>

Base units
Módulos bajos
Modules Bas

Base unit with door
Módulo bajo con puerta
Module bas avec porte

H. 60

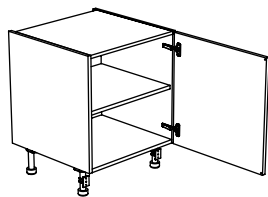

Base unit with door.
1 door.
1 shelf..

Módulo bajo con puerta.
1 puerta.
1 balda.

Modules bas avec porte.
1 porte.
1 étagère.

Availability / disponibilidad / disponibilité:

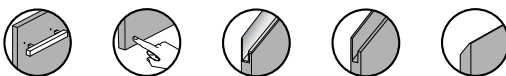

61 depth / profundidad / profondeur

SAP	Code Código Code	Width Ancho Largeur	Opening Apertura Ouverture											
				0	1	2	3	4	5	6	7	8	9	10
700020391	BP 0005	30	L / R	312	338	-	376	405	426	-	459	-	-	-
700020392	BP 0005	40	L / R	321	350	-	391	419	442	-	477	-	-	-
700020393	BP 0005	45	L / R	326	356	-	399	427	450	-	488	-	-	-
700020394	BP 0005	50	L / R	330	362	-	406	434	458	-	494	-	-	-
700020395	BP 0005	60	L / R	351	388	-	437	466	494	-	536	-	-	-

45 depth / profundidad / profondeur

SAP	Code Código Code	Width Ancho Largeur	Opening Apertura Ouverture											
				0	1	2	3	4	5	6	7	8	9	10
700020396	BP 0006	30	L / R	292	318	-	354	383	405	-	437	-	-	-
700020397	BP 0006	40	L / R	299	329	-	368	396	419	-	457	-	-	-
700020398	BP 0006	45	L / R	303	334	-	375	403	426	-	463	-	-	-
700020399	BP 0006	50	L / R	307	339	-	382	409	433	-	468	-	-	-
700020400	BP 0006	60	L / R	317	355	-	401	430	457	-	494	-	-	-

35 depth / profundidad / profondeur

SAP	Code Código Code	Width Ancho Largeur	Opening Apertura Ouverture											
				0	1	2	3	4	5	6	7	8	9	10
700020401	BP 0007	30	L / R	279	306	-	344	370	391	-	422	-	-	-
700020402	BP 0007	40	L / R	289	319	-	360	385	408	-	441	-	-	-
700020403	BP 0007	45	L / R	292	323	-	367	391	414	-	446	-	-	-
700020404	BP 0007	50	L / R	295	328	-	370	397	420	-	451	-	-	-
700020405	BP 0007	60	L / R	304	343	-	388	417	444	-	480	-	-	-

H. 60

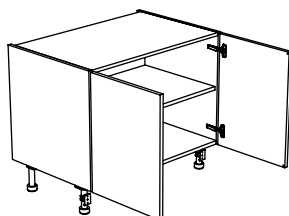

Base unit with door.
2 doors.
1 shelf.

Módulo bajo con puerta.
2 puertas.
1 balda.

Modules bas avec porte.
2 portes.
1 étagère.

Availability / disponibilidad / disponibilité:

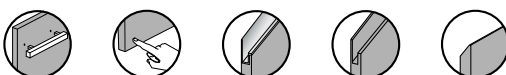

61 depth / profundidad / profondeur

SAP	Code Código Code	Width Ancho Largeur	Opening Apertura Ouverture											
				0	1	2	3	4	5	6	7	8	9	10
700020406	BP 0008	76,2	-	382	448	-	512	567	604	-	670	-	-	-
700020407	BP 0008	80	-	385	453	-	517	569	622	-	678	-	-	-
700020408	BP 0008	90	-	395	465	-	533	584	626	-	700	-	-	-
700020409	BP 0008	100	-	404	477	-	549	599	642	-	722	-	-	-
700020410	BP 0008	120	-	433	517	-	598	650	700	-	794	-	-	-

45 depth / profundidad / profondeur

SAP	Code Código Code	Width Ancho Largeur	Opening Apertura Ouverture											
				0	1	2	3	4	5	6	7	8	9	10
700020411	BP 0009	76,2	-	352	419	-	480	536	572	-	636	-	-	-
700020412	BP 0009	80	-	357	426	-	488	540	580	-	647	-	-	-
700020413	BP 0009	90	-	365	436	-	502	553	594	-	667	-	-	-
700020414	BP 0009	100	-	373	447	-	516	566	609	-	681	-	-	-
700020415	BP 0009	120	-	390	476	-	553	605	655	-	732	-	-	-

35 depth / profundidad / profondeur

SAP	Code Código Code	Width Ancho Largeur	Opening Apertura Ouverture											
				0	1	2	3	4	5	6	7	8	9	10
700020416	BP 0010	76,2	-	330	399	-	457	513	549	-	613	-	-	-
700020417	BP 0010	80	-	333	402	-	462	514	554	-	614	-	-	-
700020418	BP 0010	90	-	346	418	-	482	533	574	-	640	-	-	-
700020419	BP 0010	100	-	353	428	-	495	545	587	-	653	-	-	-
700020420	BP 0010	120	-	370	457	-	532	584	634	-	711	-	-	-

Base units
Módulos bajos
Modules Bas

Base corner unit
Módulo bajo rinconero
Module bas encoignure

H. 60

Base straight corner unit.
1 door.
1 shelf.
1 standard corner filler, 10x10 cm.

Módulo bajo rinconero recto.
1 puerta.
1 balda.
1 regleta de rincón estándar de 10x10 cm.

Modules bas encoignure droite.
1 porte.
1 étagère.
1 fileur d'encoignure standard, 10x10 cm.

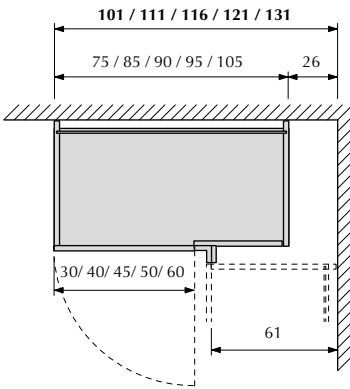
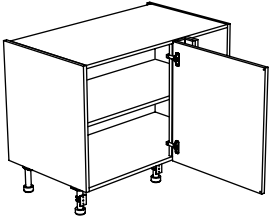

Availability / disponibilidad / disponibilité:

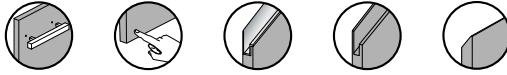

61 depth / profundidad / profondeur

SAP	Code Código Code	Width Ancho Largeur	Opening Apertura Ouverture	0	1	2	3	4	5	6	7	8	9	10
700020421	BRR 0011	101	L / R	475	529	-	592	614	646	-	691	-	-	-
700020422	BRR 0011	111	L / R	484	541	-	607	640	662	-	713	-	-	-
700020423	BRR 0011	116	L / R	489	547	-	615	647	670	-	724	-	-	-
700020424	BRR 0011	121	L / R	493	553	-	623	655	678	-	735	-	-	-
700020425	BRR 0011	131	L / R	505	570	-	644	677	691	-	752	-	-	-

H. 60

Base straight corner unit.
1 door.
1 shelf.
1 corner filler with raised door profile, 4x4 cm.

Módulo bajo rinconero recto.
1 puerta.
1 balda.
1 regleta de rincón con perfil de puerta de 4x4 cm.

Modules bas encoignure droite.
1 porte.
1 étagère.
1 Fileur d'encoignure avec profilé de porte, 4x4 cm.

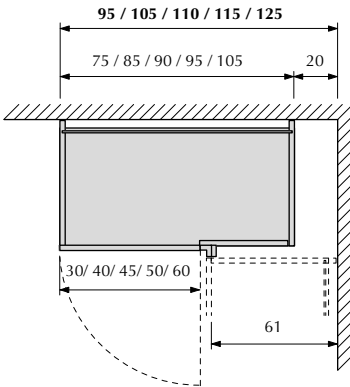
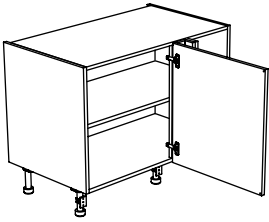

Availability / disponibilidad / disponibilité:

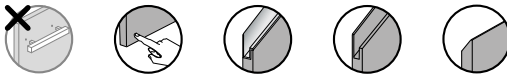

61 depth / profundidad / profondeur

SAP	Code Código Code	Width Ancho Largeur	Opening Apertura Ouverture	0	1	2	3	4	5	6	7	8	9	10
700020804	BRR 0011	95	L / R	475	529	-	597	670	690	-	736	-	-	-
700020805	BRR 0011	105	L / R	484	541	-	613	684	706	-	758	-	-	-
700020806	BRR 0011	110	L / R	489	547	-	621	692	714	-	768	-	-	-
700020807	BRR 0011	115	L / R	493	553	-	628	699	722	-	779	-	-	-
700020808	BRR 0011	125	L / R	505	570	-	644	721	748	-	811	-	-	-

Base units
Módulos bajos
Modules Bas

Base unit with drawers
Módulo bajo con cajones
Module bas avec tiroirs

H. 60

Base unit with drawers.
1 deep drawer.

Módulo bajo con cajones.
1 gaveta.

Modules bas avec tiroirs.
1 extractible.

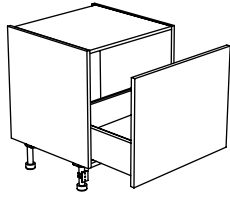

Availability / disponibilidad / disponibilité:

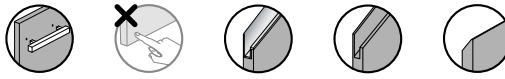

61 depth / profundidad / profondeur

SAP	Code Código Code	Width Ancho Largeur	Opening Apertura Ouverture											
				0	1	2	3	4	5	6	7	8	9	10
700020426	BE 0012	30	-	478	497	-	549	578	603	-	643	-	-	-
700020427	BE 0012	40	-	488	509	-	565	593	620	-	666	-	-	-
700020428	BE 0012	45	-	493	516	-	573	601	628	-	677	-	-	-
700020429	BE 0012	50	-	498	522	-	581	609	636	-	688	-	-	-
700020430	BE 0012	60	-	517	547	-	610	639	670	-	729	-	-	-
700020431	BE 0012	76,2	-	537	571	-	641	671	701	-	756	-	-	-
700020432	BE 0012	80	-	541	575	-	647	686	707	-	764	-	-	-
700020433	BE 0012	90	-	556	593	-	668	708	729	-	785	-	-	-
700020434	BE 0012	100	-	566	606	-	684	711	746	-	807	-	-	-
700020435	BE 0012	120	-	599	647	-	734	778	805	-	877	-	-	-

45 depth / profundidad / profondeur

SAP	Code Código Code	Width Ancho Largeur	Opening Apertura Ouverture											
				0	1	2	3	4	5	6	7	8	9	10
700020436	BE 0013	30	-	467	486	-	537	567	591	-	630	-	-	-
700020437	BE 0013	40	-	476	498	-	553	581	607	-	653	-	-	-
700020438	BE 0013	45	-	481	504	-	560	599	615	-	663	-	-	-
700020439	BE 0013	50	-	485	509	-	568	601	622	-	674	-	-	-
700020440	BE 0013	60	-	496	526	-	588	617	648	-	706	-	-	-
700020441	BE 0013	76,2	-	518	552	-	620	651	681	-	742	-	-	-
700020442	BE 0013	80	-	521	556	-	626	653	686	-	746	-	-	-
700020443	BE 0013	90	-	537	575	-	649	676	710	-	772	-	-	-
700020444	BE 0013	100	-	546	586	-	663	690	725	-	786	-	-	-
700020445	BE 0013	120	-	570	619	-	704	733	774	-	838	-	-	-

H. 60

Base unit with drawers.
1 deep drawer.
1 interior drawer.

Módulo bajo con cajones.
1 gaveta.
1 cajón interior.

Modules bas avec tiroirs.
1 extractible.
1 tiroir intérieur.

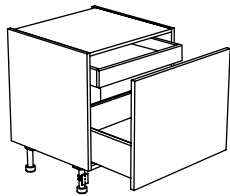

Availability / disponibilidad / disponibilité:

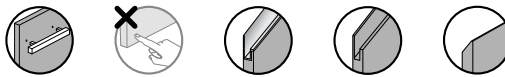

61 depth / profundidad / profondeur

SAP	Code Código Code	Width Ancho Largeur	Opening Apertura Ouverture											
				0	1	2	3	4	5	6	7	8	9	10
700020446	BE 0014	30	-	643	655	-	722	751	779	-	825	-	-	-
700020447	BE 0014	40	-	657	672	-	742	770	800	-	845	-	-	-
700020448	BE 0014	45	-	665	680	-	753	781	810	-	858	-	-	-
700020449	BE 0014	50	-	672	688	-	763	791	821	-	872	-	-	-
700020450	BE 0014	60	-	695	717	-	797	825	860	-	917	-	-	-
700020451	BE 0014	76,2	-	724	750	-	837	867	901	-	968	-	-	-
700020452	BE 0014	80	-	730	757	-	845	872	909	-	979	-	-	-
700020453	BE 0014	90	-	750	780	-	872	899	937	-	1004	-	-	-
700020454	BE 0014	100	-	765	796	-	892	920	958	-	1021	-	-	-
700020455	BE 0014	120	-	807	846	-	951	981	1026	-	1090	-	-	-

45 depth / profundidad / profondeur

SAP	Code Código Code	Width Ancho Largeur	Opening Apertura Ouverture											
				0	1	2	3	4	5	6	7	8	9	10
700020456	BE 0015	30	-	638	650	-	716	745	773	-	819	-	-	-
700020457	BE 0015	40	-	652	667	-	737	765	794	-	839	-	-	-
700020458	BE 0015	45	-	658	674	-	746	774	804	-	851	-	-	-
700020459	BE 0015	50	-	664	682	-	762	783	813	-	864	-	-	-
700020460	BE 0015	60	-	679	702	-	780	809	843	-	892	-	-	-
700020461	BE 0015	76,2	-	708	734	-	819	849	883	-	932	-	-	-
700020462	BE 0015	80	-	712	740	-	826	854	890	-	942	-	-	-
700020463	BE 0015	90	-	736	766	-	857	884	922	-	970	-	-	-
700020464	BE 0015	100	-	749	781	-	876	903	941	-	985	-	-	-
700020465	BE 0015	120	-	781	821	-	924	954	998	-	1053	-	-	-

Base units
Módulos bajos
Modules Bas

Base unit with drawers
Módulo bajo con cajones
Module bas avec tiroirs

H. 60

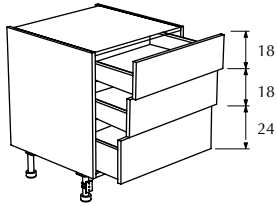

Base unit with drawers.
3 drawers.

Módulo bajo con cajones.
3 cajones.

Modules bas avec tiroirs.
3 tiroirs.

Availability / disponibilidad / disponibilité:

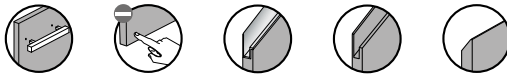

61 depth / profundidad / profondeur

SAP	Code Código Code	Width Ancho Largeur	Opening Apertura Ouverture											
				0	1	2	3	4	5	6	7	8	9	10
700020466	BCE 0016	30	-	757	817	-	915	976	1024	-	1090	-	-	-
700020467	BCE 0016	40	-	774	837	-	931	1002	1059	-	1122	-	-	-
700020468	BCE 0016	45	-	783	849	-	945	1018	1067	-	1143	-	-	-
700020469	BCE 0016	50	-	791	859	-	957	1032	1080	-	1159	-	-	-
700020470	BCE 0016	60	-	818	890	-	995	1073	1134	-	1212	-	-	-
700020471	BCE 0016	76,2	-	853	930	-	1043	1133	1184	-	1272	-	-	-
700020472	BCE 0016	80	-	860	938	-	1052	1135	1193	-	1284	-	-	-
700020473	BCE 0016	90	-	883	964	-	1082	1168	1225	-	1322	-	-	-
700020474	BCE 0016	100	-	900	984	-	1107	1197	1250	-	1354	-	-	-
700020475	BCE 0016	120	-	949	1038	-	1172	1265	1316	-	1406	-	-	-

45 depth / profundidad / profondeur

SAP	Code Código Code	Width Ancho Largeur	Opening Apertura Ouverture											
				0	1	2	3	4	5	6	7	8	9	10
700020476	BCE 0017	30	-	755	815	-	904	974	1022	-	1088	-	-	-
700020477	BCE 0017	40	-	773	836	-	930	1001	1048	-	1121	-	-	-
700020478	BCE 0017	45	-	781	847	-	943	1016	1065	-	1141	-	-	-
700020479	BCE 0017	50	-	788	856	-	954	1029	1076	-	1156	-	-	-
700020480	BCE 0017	60	-	806	879	-	982	1061	1111	-	1198	-	-	-
700020481	BCE 0017	76,2	-	837	915	-	1026	1116	1156	-	1242	-	-	-
700020482	BCE 0017	80	-	843	922	-	1034	1117	1165	-	1253	-	-	-
700020483	BCE 0017	90	-	871	952	-	1070	1156	1201	-	1284	-	-	-
700020484	BCE 0017	100	-	887	971	-	1093	1183	1224	-	1314	-	-	-
700020485	BCE 0017	120	-	924	1015	-	1146	1240	1290	-	1380	-	-	-

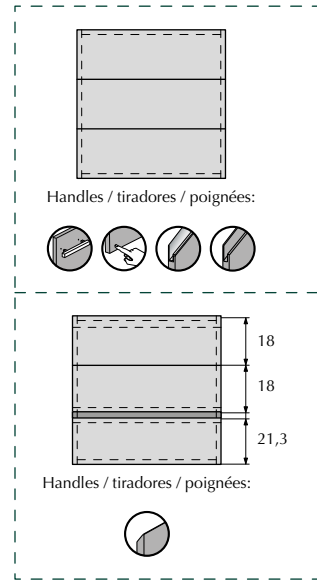

H. 60

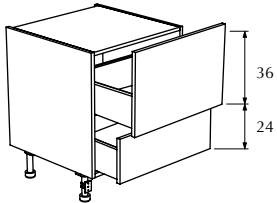

Base unit with drawers.
1 deep drawer.
1 drawer.

Módulo bajo con cajones.
1 gaveta.
1 cajón.

Modules bas avec tiroirs.
1 extractible.
1 tiroir.

Availability / disponibilidad / disponibilité:

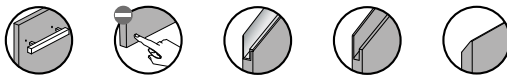

61 depth / profundidad / profondeur

SAP	Code Código Code	Width Ancho Largeur	Opening Apertura Ouverture											
				0	1	2	3	4	5	6	7	8	9	10
700020486	BE 0018	30	-	644	683	-	759	826	875	-	943	-	-	-
700020487	BE 0018	40	-	658	700	-	780	848	896	-	970	-	-	-
700020488	BE 0018	45	-	664	709	-	791	862	911	-	989	-	-	-
700020489	BE 0018	50	-	671	717	-	801	874	921	-	1002	-	-	-
700020490	BE 0018	60	-	694	742	-	831	906	951	-	1039	-	-	-
700020491	BE 0018	76,2	-	722	774	-	871	956	1000	-	1090	-	-	-
700020492	BE 0018	80	-	727	780	-	878	957	1008	-	1101	-	-	-
700020493	BE 0018	90	-	745	805	-	908	991	1045	-	1135	-	-	-
700020494	BE 0018	100	-	759	821	-	928	1017	1066	-	1151	-	-	-
700020495	BE 0018	120	-	799	867	-	983	1076	1122	-	1208	-	-	-

45 depth / profundidad / profondeur

SAP	Code Código Code	Width Ancho Largeur	Opening Apertura Ouverture											
				0	1	2	3	4	5	6	7	8	9	10
700020496	BE 0019	30	-	639	678	-	753	821	870	-	937	-	-	-
700020497	BE 0019	40	-	652	694	-	774	843	890	-	964	-	-	-
700020498	BE 0019	45	-	658	703	-	785	856	904	-	982	-	-	-
700020499	BE 0019	50	-	664	710	-	794	866	914	-	994	-	-	-
700020500	BE 0019	60	-	678	727	-	815	890	935	-	1022	-	-	-
700020501	BE 0019	76,2	-	705	758	-	853	939	973	-	1061	-	-	-
700020502	BE 0019	80	-	709	764	-	860	943	989	-	1071	-	-	-
700020503	BE 0019	90	-	731	791	-	893	976	1030	-	1108	-	-	-
700020504	BE 0019	100	-	743	806	-	911	1000	1049	-	1133	-	-	-
700020505	BE 0019	120	-	773	842	-	956	1049	1094	-	1180	-	-	-

Base units
Módulos bajos
Modules Bas

Base unit with drawers
Módulo bajo con cajones
Module bas avec tiroirs

H. 60

Base unit with drawers.
1 drawer.
1 deep drawer.

Módulo bajo con cajones.
1 cajón.
1 gaveta.

Modules bas avec tiroirs.
1 tiroir.
1 extractible.

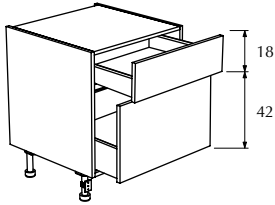

Availability / disponibilidad / disponibilité:

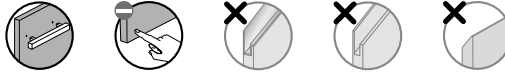

61 depth / profundidad / profondeur

SAP	Code Código Code	Width Ancho Largeur	Opening Apertura Ouverture	0	1	2	3	4	5	6	7	8	9	10
				700020506	BCE 0020	30	-	644	683	-	739		797	-
700020507	BCE 0020	40	-	658	699	-	759		824	-	-	-	-	-
700020508	BCE 0020	45	-	664	708	-	769		837	-	-	-	-	-
700020509	BCE 0020	50	-	671	716	-	779		850	-	-	-	-	-
700020510	BCE 0020	60	-	694	742	-	816		888	-	-	-	-	-
700020511	BCE 0020	76,2	-	722	778	-	858		941	-	-	-	-	-
700020512	BCE 0020	80	-	727	784	-	866		951	-	-	-	-	-
700020513	BCE 0020	90	-	745	805	-	891		983	-	-	-	-	-
700020514	BCE 0020	100	-	759	821	-	911		1009	-	-	-	-	-
700020515	BCE 0020	120	-	799	867	-	965		1066	-	-	-	-	-

45 depth / profundidad / profondeur

SAP	Code Código Code	Width Ancho Largeur	Opening Apertura Ouverture	0	1	2	3	4	5	6	7	8	9	10
				700020516	BCE 0021	30	-	639	678	-	733		791	-
700020517	BCE 0021	40	-	652	694	-	753		818	-	-	-	-	-
700020518	BCE 0021	45	-	658	702	-	762		830	-	-	-	-	-
700020519	BCE 0021	50	-	664	709	-	771		842	-	-	-	-	-
700020520	BCE 0021	60	-	678	727	-	800		871	-	-	-	-	-
700020521	BCE 0021	76,2	-	705	761	-	841		922	-	-	-	-	-
700020522	BCE 0021	80	-	709	767	-	848		932	-	-	-	-	-
700020523	BCE 0021	90	-	731	791	-	877		967	-	-	-	-	-
700020524	BCE 0021	100	-	743	806	-	895		992	-	-	-	-	-
700020525	BCE 0021	120	-	773	842	-	939		1039	-	-	-	-	-

Base units
Módulos bajos
Modules Bas

Standard base sink unit
Módulo bajo fregadero estándar
Module bas évier standard

H. 60

Base sink unit with door.
1 door.
1 protection mat.

Módulo bajo fregadero con puerta.
1 puerta.
1 base protectora.

Modules bas évier avec porte.
1 porte.
1 base de protection.

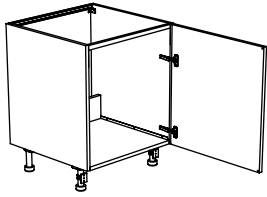

Availability / disponibilidad / disponibilité:

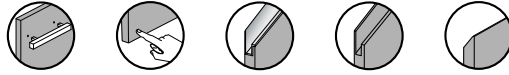

61 depth / profundidad / profondeur

SAP	Code Código Code	Width Ancho Largeur	Opening Apertura Ouverture	0	1	2	3	4	5	6	7	8	9	10
				700020526	BF 0022	45	L / R	306	337	-	382	406	429	-
700020527	BF 0022	50	L / R	310	342	-	389	413	436	-	472	-	-	-
700020528	BF 0022	60	L / R	325	363	-	414	439	466	-	508	-	-	-

H. 60

Base sink unit with door.
2 doors.
1 protection mat.

Módulo bajo fregadero con puerta.
2 puertas.
1 base protectora.

Modules bas évier avec porte.
2 portes.
1 base de protection.

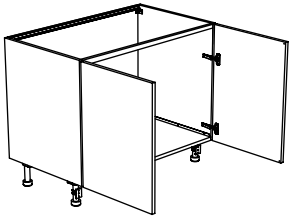

Availability / disponibilidad / disponibilité:

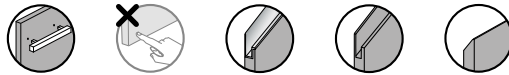

61 depth / profundidad / profondeur

SAP	Code Código Code	Width Ancho Largeur	Opening Apertura Ouverture	0	1	2	3	4	5	6	7	8	9	10
				700020529	BF 0023	76,2	-	355	423	-	483	539	576	-
700020530	BF 0023	80	-	357	426	-	488	540	580	-	635	-	-	-
700020531	BF 0023	90	-	369	440	-	506	558	599	-	659	-	-	-
700020532	BF 0023	100	-	376	450	-	519	570	612	-	678	-	-	-
700020533	BF 0023	120	-	401	487	-	564	617	666	-	731	-	-	-

H. 60

Base sink unit with deep drawer.
1 deep drawer.

Módulo bajo fregadero con gaveta.
1 gaveta.

Modules bas évier avec extractible.
1 extractible.

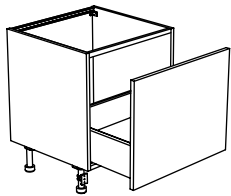

Availability / disponibilidad / disponibilité:

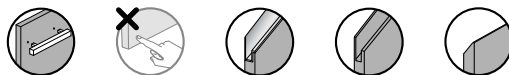

61 depth / profundidad / profondeur

SAP	Code Código Code	Width Ancho Largeur	Opening Apertura Ouverture	0	1	2	3	4	5	6	7	8	9	10
				700020534	BFC 0024	45	-	474	498	-	554	582	608	-
700020535	BFC 0024	50	-	480	505	-	562	590	617	-	656	-	-	-
700020536	BFC 0024	60	-	493	524	-	586	614	645	-	690	-	-	-
700020537	BFC 0024	76,2	-	511	546	-	614	644	674	-	721	-	-	-
700020538	BFC 0024	80	-	515	551	-	620	647	680	-	723	-	-	-
700020539	BFC 0024	90	-	532	570	-	643	670	704	-	752	-	-	-
700020540	BFC 0024	100	-	539	580	-	656	683	717	-	771	-	-	-
700020541	BFC 0024	120	-	569	618	-	703	732	773	-	830	-	-	-

H. 60

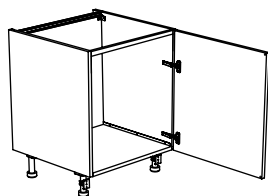

Base sink unit with door for USA.
1 door.
1 protection mat.
Full back panel.

Bajo fregadero con puerta para USA.
1 puerta.
1 base protectora.
Trasera completa.

Modules bas évier avec porte pour USA.
1 porte.
1 base de protection.
Panneau arrière complet.

Availability / disponibilidad / disponibilité:

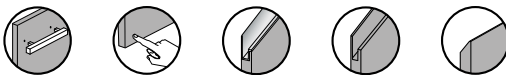

61 depth / profundidad / profondeur

SAP	Code Código Code	Width Ancho Largeur	Opening Apertura Ouverture	0	1	2	3	4	5	6	7	8	9	10
				700020771	BF 0067	45	L / R	312	342	-	388	412	435	-
700020772	BF 0067	50	L / R	317	348	-	395	419	443	-	479	-	-	-
700020773	BF 0067	60	L / R	333	370	-	422	446	474	-	516	-	-	-

H. 60

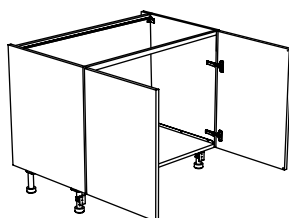

Base sink unit with door for USA.
2 doors.
1 protection mat.
Full back panel.

Bajo fregadero con puerta para USA.
2 puertas.
1 base protectora.
Trasera completa.

Modules bas évier avec porte pour USA.
2 portes.
1 base de protection.
Panneau arrière complet.

Availability / disponibilidad / disponibilité:

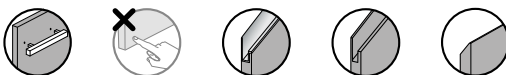

61 depth / profundidad / profondeur

SAP	Code Código Code	Width Ancho Largeur	Opening Apertura Ouverture	0	1	2	3	4	5	6	7	8	9	10
				700020774	BF 0068	76,2	-	364	431	-	493	549	585	-
700020775	BF 0068	80	-	367	435	-	498	550	590	-	645	-	-	-
700020776	BF 0068	90	-	382	452	-	519	571	612	-	673	-	-	-
700020777	BF 0068	100	-	389	463	-	533	584	626	-	693	-	-	-
700020778	BF 0068	120	-	417	502	-	581	633	683	-	761	-	-	-

H. 60

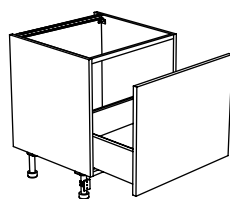

Base sink unit with deep drawer for USA.
1 deep drawer.
Full back panel.

Módulo bajo fregadero con gaveta para USA.
1 gaveta.
Trasera completa.

Modules bas évier avec extractible pour USA.
1 extractible.
Panneau arrière complet.

Availability / disponibilidad / disponibilité:

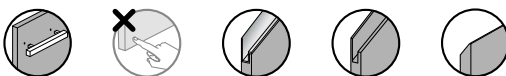

61 depth / profundidad / profondeur

SAP	Code Código Code	Width Ancho Largeur	Opening Apertura Ouverture	0	1	2	3	4	5	6	7	8	9	10
				700020779	BFC 0069	45	-	480	503	-	560	588	614	-
700020780	BFC 0069	50	-	486	511	-	569	596	623	-	662	-	-	-
700020781	BFC 0069	60	-	500	531	-	593	622	652	-	697	-	-	-
700020782	BFC 0069	76,2	-	520	555	-	623	654	684	-	738	-	-	-
700020783	BFC 0069	80	-	524	560	-	630	657	690	-	747	-	-	-
700020784	BFC 0069	90	-	544	582	-	656	683	717	-	780	-	-	-
700020785	BFC 0069	100	-	552	593	-	670	697	732	-	800	-	-	-
700020786	BFC 0069	120	-	585	633	-	719	749	790	-	854	-	-	-

H. 60

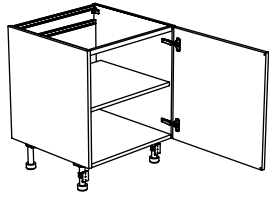

Base unit for hob with door.
1 door.
1 shelf.
Back panel with a gap for appliances ventilation.

Módulo bajo para placa con puerta.
1 puerta.
1 balda.
Trasera con hueco para ventilación de electrodomésticos.

Module bas pour plaque avec porte.
1 porte.
1 étagère.
Panneau arrière avec espace pour aération des électroménagers.

Availability / disponibilidad / disponibilité:

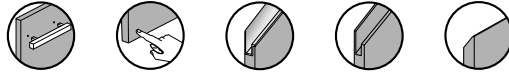

61 depth / profundidad / profondeur

SAP	Code Código Code	Width Ancho Largeur	Opening Apertura Ouverture	0	1	2	3	4	5	6	7	8	9	10
				700020542	BPL 0025	40	L / R	314	342	-	386	411	434	-
700020543	BPL 0025	45	L / R	317	347	-	392	417	440	-	473	-	-	-
700020544	BPL 0025	50	L / R	322	354	-	401	425	449	-	485	-	-	-
700020545	BPL 0025	60	L / R	339	376	-	425	453	481	-	523	-	-	-

H. 60

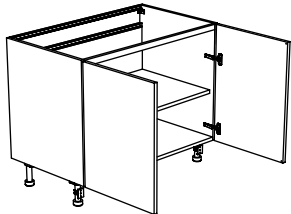

Base unit for hob with doors.
2 doors.
1 shelf.
Back panel with a gap for appliances ventilation.

Módulo bajo para placa con puertas.
2 puertas.
1 balda.
Trasera con hueco para ventilación de electrodomésticos.

Module bas pour plaque avec portes.
2 portes.
1 étagère.
Panneau arrière avec espace pour aération des électroménagers.

Availability / disponibilidad / disponibilité:

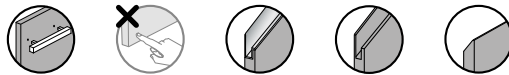

61 depth / profundidad / profondeur

SAP	Code Código Code	Width Ancho Largeur	Opening Apertura Ouverture	0	1	2	3	4	5	6	7	8	9	10
				700020546	BPL 0026	76,2	-	369	436	-	498	544	590	-
700020547	BPL 0026	80	-	373	440	-	504	546	596	-	664	-	-	-
700020548	BPL 0026	90	-	385	456	-	523	569	616	-	677	-	-	-
700020549	BPL 0026	100	-	393	466	-	537	583	630	-	697	-	-	-
700020550	BPL 0026	120	-	457	540	-	623	675	726	-	805	-	-	-

H. 60

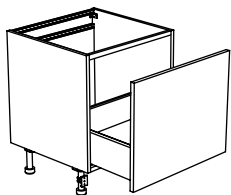

Base unit for hob with deep drawer.
1 deep drawer.
Back panel with a gap for appliances ventilation.

Módulo bajo para placa con gaveta.
1 gaveta.
Trasera con hueco para ventilación de electrodomésticos.

Module bas pour plaque avec extractible.
1 extractible.
Panneau arrière avec espace pour aération des électroménagers.

Availability / disponibilidad / disponibilité:

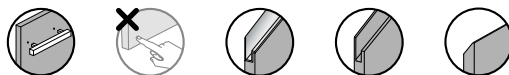

61 depth / profundidad / profondeur

SAP	Code Código Code	Width Ancho Largeur	Opening Apertura Ouverture	0	1	2	3	4	5	6	7	8	9	10
				700020551	BPL 0027	40	-	475	497	-	552	580	606	-
700020552	BPL 0027	45	-	479	502	-	558	586	607	-	649	-	-	-
700020553	BPL 0027	50	-	485	509	-	567	595	616	-	661	-	-	-
700020554	BPL 0027	60	-	500	539	-	593	621	646	-	697	-	-	-
700020555	BPL 0027	76,2	-	524	568	-	627	657	681	-	728	-	-	-
700020556	BPL 0027	80	-	533	578	-	639	666	693	-	742	-	-	-
700020557	BPL 0027	90	-	546	594	-	658	685	719	-	768	-	-	-
700020558	BPL 0027	100	-	555	606	-	673	700	735	-	788	-	-	-
700020559	BPL 0027	120	-	588	647	-	710	752	793	-	874	-	-	-

Base units
Módulos bajos
Modules Bas

Base unit for hob
Módulo bajo para placa de cocción
Module bas pour plaque de cuisson

H. 60

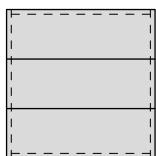
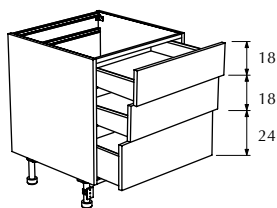

Handles / tiradores / poignées:

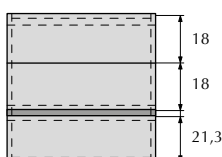

Handles / tiradores / poignées:



Base unit for hob with drawers.
3 drawers.
Back panel with a gap for appliances ventilation.

Módulo bajo para placa con cajones.
3 cajones.
Trasera con hueco para ventilación de electrodomésticos.

Module bas pour plaque avec tiroirs.
3 tiroirs.
Panneau arrière avec espace pour aération des électroménagers.

Availability / disponibilidad / disponibilité:

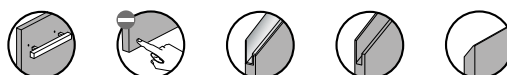

61 depth / profundidad / profondeur

SAP	Code Código Code	Width Ancho Largeur	Opening Apertura Ouverture											
				0	1	2	3	4	5	6	7	8	9	10
700020560	BPL 0028	40	-	761	825	-	918	989	1036	-	1108	-	-	-
700020561	BPL 0028	45	-	768	835	-	930	1003	1052	-	1128	-	-	-
700020562	BPL 0028	50	-	778	846	-	944	1018	1066	-	1145	-	-	-
700020563	BPL 0028	60	-	801	874	-	977	1056	1106	-	1181	-	-	-
700020564	BPL 0028	76,2	-	841	918	-	1029	1119	1159	-	1234	-	-	-
700020565	BPL 0028	80	-	847	926	-	1039	1122	1169	-	1246	-	-	-
700020566	BPL 0028	90	-	873	955	-	1073	1159	1203	-	1287	-	-	-
700020567	BPL 0028	100	-	890	974	-	1096	1186	1239	-	1317	-	-	-
700020568	BPL 0028	120	-	938	1028	-	1160	1254	1304	-	1395	-	-	-

H. 60

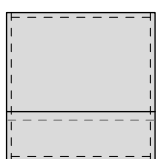
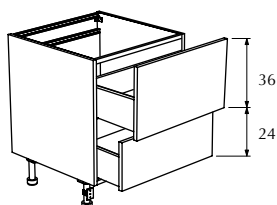

Handles / tiradores / poignées:

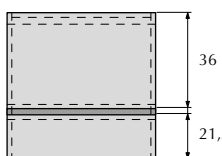

Handles / tiradores / poignées:



Base unit for hob with deep drawer.
1 deep drawer.
1 drawer.
Back panel with a gap for appliances ventilation.

Módulo bajo para placa con gaveta.
1 gaveta.
1 cajón.
Trasera con hueco para ventilación de electrodomésticos.

Module bas pour plaque avec extractible.
1 extractible.
1 tiroir.
Panneau arrière avec espace pour aération des électroménagers.

Availability / disponibilidad / disponibilité:

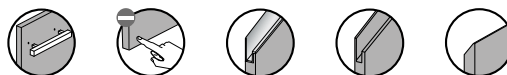

61 depth / profundidad / profondeur

SAP	Code Código Code	Width Ancho Largeur	Opening Apertura Ouverture											
				0	1	2	3	4	5	6	7	8	9	10
700020569	BPL 0029	40	-	645	687	-	766	835	883	-	956	-	-	-
700020570	BPL 0029	45	-	650	695	-	776	847	896	-	964	-	-	-
700020571	BPL 0029	50	-	658	704	-	787	860	907	-	978	-	-	-
700020572	BPL 0029	60	-	677	726	-	813	888	933	-	1001	-	-	-
700020573	BPL 0029	76,2	-	709	762	-	857	943	977	-	1056	-	-	-
700020574	BPL 0029	80	-	714	768	-	865	944	985	-	1066	-	-	-
700020575	BPL 0029	90	-	736	796	-	898	981	1045	-	1135	-	-	-
700020576	BPL 0029	100	-	748	811	-	917	1006	1055	-	1139	-	-	-
700020577	BPL 0029	120	-	788	857	-	972	1065	1100	-	1163	-	-	-

Base units
Módulos bajos
Modules Bas

Base unit for hob
Módulo bajo para placa de cocción
Module bas pour plaque de cuisson

H. 60

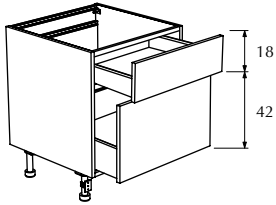

Base unit for hob with deep drawer.
1 drawer.
1 deep drawer.
Back panel with a gap for appliances ventilation.

Módulo bajo para placa con gaveta.
1 cajón.
1 gaveta.
Trasera con hueco para ventilación de electrodomésticos.

Module bas pour plaque avec extractible.
1 tiroir.
1 extractible.
Panneau arrière avec espace pour aération des électroménagers.

Availability / disponibilidad / disponibilité:



61 depth / profundidad / profondeur

SAP	Code Código Code	Width Ancho Largeur	Opening Apertura Ouverture											
				0	1	2	3	4	5	6	7	8	9	10
700020578	BPL 0030	40	-	645	687	-	746		810	-	-	-	-	-
700020579	BPL 0030	45	-	650	694	-	754		821	-	-	-	-	-
700020580	BPL 0030	50	-	658	703	-	765		836	-	-	-	-	-
700020581	BPL 0030	60	-	677	726	-	799		869	-	-	-	-	-
700020582	BPL 0030	76,2	-	709	765	-	845		927	-	-	-	-	-
700020583	BPL 0030	80	-	714	772	-	853		937	-	-	-	-	-
700020584	BPL 0030	90	-	736	796	-	882		972	-	-	-	-	-
700020585	BPL 0030	100	-	748	811	-	900		997	-	-	-	-	-
700020586	BPL 0030	120	-	788	857	-	954		1065	-	-	-	-	-

Base units
Módulos bajos
Modules Bas

Base unit for hob and oven
Módulo bajo para placa de cocción y horno
Module bas pour plaque de cuisson et four

H. 60

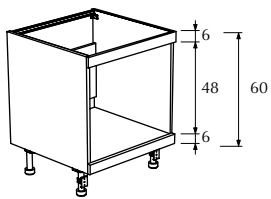

Base unit for oven / microwave.
1 installation space , 48 cm high.
2 fillers, 6 cm height

Módulo bajo para horno/ microondas.
1 hueco integración de 48 cm.
2 regletas de 6 cm de alto.











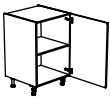
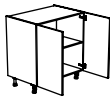

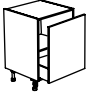
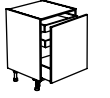



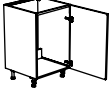
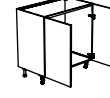

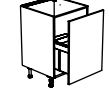
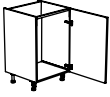
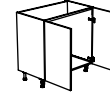
Module bas pour four / micro-ondes.
1 espace d'intégration de 48 cm.
2 fileurs, 6 cm d'hauteur.

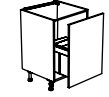
61 depth / profundidad / profondeur

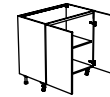
SAP	Code Código Code	Width Ancho Largeur	Opening Apertura Ouverture											
				0	1	2	3	4	5	6	7	8	9	10
700020587	BH 0031	60	-	291	365	-	408	437	452	-	473	-	-	-
700020588	BH 0031	76,2	-	302	380	-	426	459	470	-	496	-	-	-
700020589	BH 0031	90	-	313	396	-	445	465	486	-	515	-	-	-

h. 78

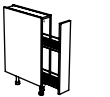
Base units
Módulos bajos
Modules bas

Type of unit Tipo de módulo Type de module	Available measures Medidas disponibles Dimensions disponibles	Available units Módulos disponibles Modules disponibles
p.66 Base unit with door Módulo bajo con puerta Module bas avec porte	Depth / Profundidad / Profondeur (cm.): 35 - 45 - 61 Width / Ancho / Largeur (cm.): 30 - 40 - 45 - 50 - 60 (1 door) 76,2 - 80 - 90 - 100 - 120 (2 doors)	 BP 0032 - 0033 - 0034  BP 0035 - 0036 - 0037
p.67 - 68 Base corner unit Módulo bajo rinconero Module bas encoignure	Depth / Profundidad / Profondeur (cm.): 61 Door width / Ancho puerta / Largeur porte: 30 - 40 - 45 - 50 - 60	 BRR 0038  BRR 0039
p.69 - 71 Base unit with drawers Módulo bajo con cajones Module bas avec tiroirs	Depth / Profundidad / Profondeur (cm.): 45 - 61 Width / Ancho / Largeur (cm.): 30 - 40 - 45 - 50 - 60 - 76,2 - 80 - 90 - 100 - 120	 BE 0040 - 0041  BE 0042 - 0043  BCE 0044 - 0045  BE 0046 - 0047  BCE 0048 - 0049
p.72 - 73 Base sink unit Módulo bajo fregadero Module bas évier	Depth / Profundidad / Profondeur (cm.): 61 Width / Ancho / Largeur (cm.): 40 - 45 - 50 - 60 (1 door) 76,2 - 80 - 90 - 100 - 120 (2 doors)	 BF 0050  BF 0051  BFE 0052  BFE 0053  BFER 0062
p.74 - 75 Base sink unit for USA Módulo bajo fregadero para USA Module bas évier pour USA	Depth / Profundidad / Profondeur (cm.): 61 Width / Ancho / Largeur (cm.): 40 - 45 - 50 - 60 (1 door) 76,2 - 80 - 90 - 100 - 120 (2 doors)	 BF 0070  BF 0071  BFE 0072  BFE 0073  BFER 0074
p.76 - 77 Base unit for hob Módulo bajo para placa de cocción Module bas pour plaque de cuisson	Depth / Profundidad / Profondeur (cm.): 61 Width / Ancho / Largeur (cm.): 40 - 45 - 50 - 60 (1 door) 76,2 - 80 - 90 - 100 - 120 (2 doors)	 BPL 0054  BPL 0055  BPL 0056  BPL 0057
p.78 Base unit for hob and oven Módulo bajo para placa y horno Module bas pour plaque et four	Depth / Profundidad / Profondeur (cm.): 61 Width / Ancho / Largeur (cm.): 60	 BH 0058  BH 0059
p.79 Base unit with special fittings Módulo bajo con herraje especial Module bas avec ferrures spécials	Depth / Profundidad / Profondeur (cm.): 61 Width / Ancho / Largeur (cm.): 15 - 30	 BEQ 0060  BEQ 0061

Base units
Módulos bajos
Modules Bas

Base unit with door
Módulo bajo con puerta
Module bas avec porte

H. 78

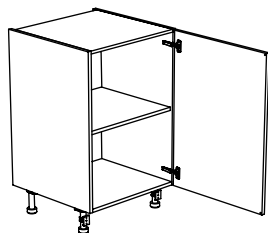

Base unit with door.
1 door.
1 shelf.

Módulo bajo con puerta.
1 puerta.
1 balda.

Modules bas avec porte.
1 porte.
1 étagère.

Availability / disponibilidad / disponibilité:

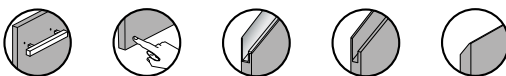

61 depth / profundidad / profondeur

SAP	Code Código Code	Width Ancho Largeur	Opening Apertura Ouverture											
				0	1	2	3	4	5	6	7	8	9	10
700020590	BP 0032	30	L / R	324	352	-	397	420	440	-	474	-	-	-
700020591	BP 0032	40	L / R	333	368	-	418	440	470	-	507	-	-	-
700020592	BP 0032	45	L / R	341	377	-	425	452	482	-	523	-	-	-
700020593	BP 0032	50	L / R	345	384	-	434	460	491	-	535	-	-	-
700020594	BP 0032	60	L / R	364	406	-	461	486	518	-	571	-	-	-

45 depth / profundidad / profondeur

SAP	Code Código Code	Width Ancho Largeur	Opening Apertura Ouverture											
				0	1	2	3	4	5	6	7	8	9	10
700020595	BP 0033	30	L / R	308	337	-	380	403	427	-	457	-	-	-
700020596	BP 0033	40	L / R	316	351	-	399	421	451	-	488	-	-	-
700020597	BP 0033	45	L / R	322	360	-	410	433	462	-	503	-	-	-
700020598	BP 0033	50	L / R	326	365	-	414	440	470	-	515	-	-	-
700020599	BP 0033	60	L / R	334	377	-	430	454	487	-	538	-	-	-

35 depth / profundidad / profondeur

SAP	Code Código Code	Width Ancho Largeur	Opening Apertura Ouverture											
				0	1	2	3	4	5	6	7	8	9	10
700020600	BP 0034	30	L / R	287	316	-	357	381	405	-	434	-	-	-
700020601	BP 0034	40	L / R	297	334	-	380	402	431	-	468	-	-	-
700020602	BP 0034	45	L / R	303	341	-	390	413	442	-	482	-	-	-
700020603	BP 0034	50	L / R	307	347	-	397	419	449	-	493	-	-	-
700020604	BP 0034	60	L / R	313	357	-	408	433	464	-	516	-	-	-

H. 78

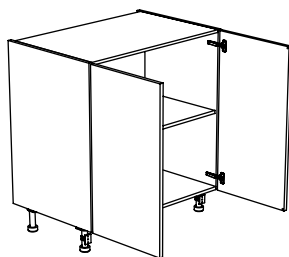

Base unit with door.
2 doors.
1 shelf.

Módulo bajo con puerta.
2 puertas.
1 balda.

Modules bas avec porte.
2 portes.
1 étagère.

Availability / disponibilidad / disponibilité:

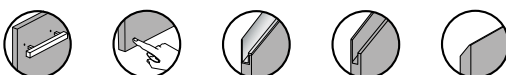

61 depth / profundidad / profondeur

SAP	Code Código Code	Width Ancho Largeur	Opening Apertura Ouverture											
				0	1	2	3	4	5	6	7	8	9	10
700020605	BP 0035	76,2	-	395	469	-	539	590	633	-	699	-	-	-
700020606	BP 0035	80	-	399	480	-	553	600	655	-	717	-	-	-
700020607	BP 0035	90	-	411	495	-	573	621	675	-	745	-	-	-
700020608	BP 0035	100	-	420	509	-	591	637	693	-	770	-	-	-
700020609	BP 0035	120	-	451	546	-	632	682	742	-	825	-	-	-

45 depth / profundidad / profondeur

SAP	Code Código Code	Width Ancho Largeur	Opening Apertura Ouverture											
				0	1	2	3	4	5	6	7	8	9	10
700020610	BP 0036	76,2	-	370	444	-	512	563	605	-	665	-	-	-
700020611	BP 0036	80	-	375	457	-	528	575	618	-	692	-	-	-
700020612	BP 0036	90	-	385	471	-	546	594	648	-	718	-	-	-
700020613	BP 0036	100	-	394	483	-	563	609	665	-	741	-	-	-
700020614	BP 0036	120	-	413	509	-	598	642	701	-	784	-	-	-

35 depth / profundidad / profondeur

SAP	Code Código Code	Width Ancho Largeur	Opening Apertura Ouverture											
				0	1	2	3	4	5	6	7	8	9	10
700020615	BP 0037	76,2	-	340	416	-	481	532	574	-	639	-	-	-
700020616	BP 0037	80	-	343	426	-	494	541	590	-	663	-	-	-
700020617	BP 0037	90	-	358	445	-	518	566	619	-	695	-	-	-
700020618	BP 0037	100	-	365	456	-	533	580	635	-	718	-	-	-
700020619	BP 0037	120	-	385	482	-	568	612	671	-	754	-	-	-

Base units
Módulos bajos
Modules Bas

Base corner unit
Módulo bajo rinconero
Module bas encoignure

H. 78

Base straight corner unit.
1 door.
1 shelf.
1 standard corner filler, 10x10 cm.

Módulo bajo rinconero recto.
1 puerta.
1 balda.
1 regleta de rincón estándar de 10x10 cm.

Modules bas encoignure droite.
1 porte.
1 étagère.
1 fileur d'encoignure standard, 10x10 cm.

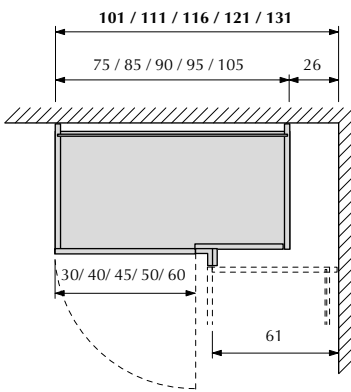
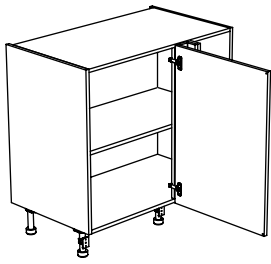

Availability / disponibilidad / disponibilité:

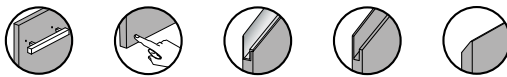

61 depth / profundidad / profondeur

SAP	Code Código Code	Width Ancho Largeur	Opening Apertura Ouverture	0	1	2	3	4	5	6	7	8	9	10
700020620	BRR 0038	101	L / R	498	558	-	627	657	683	-	738	-	-	-
700020621	BRR 0038	111	L / R	510	576	-	650	679	710	-	773	-	-	-
700020622	BRR 0038	116	L / R	515	583	-	659	689	719	-	786	-	-	-
700020623	BRR 0038	121	L / R	519	589	-	668	697	728	-	791	-	-	-
700020624	BRR 0038	131	L / R	529	603	-	685	713	747	-	817	-	-	-

H. 78

Base straight corner unit.
1 door.
1 shelf.
1 corner filler with raised door profile, 4x4 cm.

Módulo bajo rinconero recto.
1 puerta.
1 balda.
1 regleta de rincón con perfil de puerta de 4x4 cm.

Modules bas encoignure droite.
1 porte.
1 étagère.
1 Fileur d'encoignure avec profilé de porte, 4x4 cm.

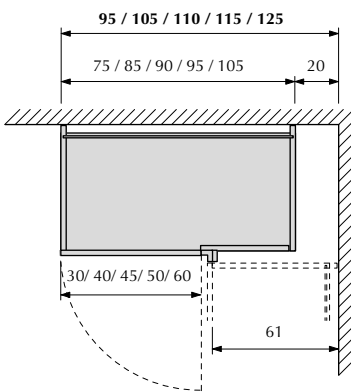
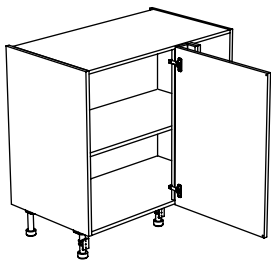

Availability / disponibilidad / disponibilité:

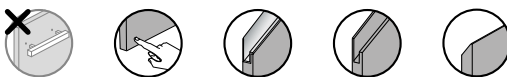

61 depth / profundidad / profondeur

SAP	Code Código Code	Width Ancho Largeur	Opening Apertura Ouverture	0	1	2	3	4	5	6	7	8	9	10
700020809	BRR 0038	95	L / R	498	558	-	633	701	727	-	783	-	-	-
700020810	BRR 0038	105	L / R	510	576	-	656	723	754	-	818	-	-	-
700020811	BRR 0038	110	L / R	515	583	-	665	732	763	-	831	-	-	-
700020812	BRR 0038	115	L / R	519	589	-	674	740	772	-	844	-	-	-
700020813	BRR 0038	125	L / R	529	603	-	691	743	791	-	861	-	-	-

Base units
Módulos bajos
Modules Bas

Base corner unit
Módulo bajo rinconero
Module bas encoignure

H. 78

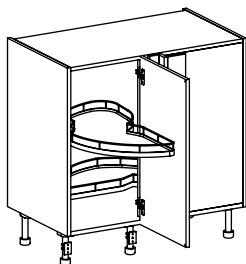

Base straight corner unit.
1 door.
2 Rotating drawers shelves.
1 standard corner filler, 10x10 cm.

Módulo bajo rinconero recto.
1 puerta.
2 Baldas giratorias y extraíbles.
1 regleta de rincón estándar de 10x10 cm.

Modules bas encoignure droite.
1 porte.
2 Étagères pivotantes extractibles.
1 fileur d'encoignure standard, 10x10 cm.

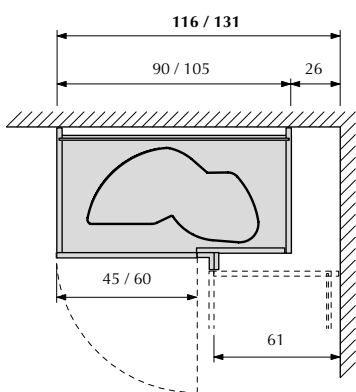

Availability / disponibilidad / disponibilité:

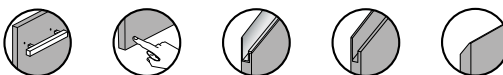

61 depth / profundidad / profondeur

SAP	Code Código Code	Width Ancho Largeur	Opening Apertura Ouverture	0	1	2	3	4	5	6	7	8	9	10
				700020625	BRR 0039	116	L / R	1387	1443	-	1571	1618	1664	-
700020627	BRR 0039	131	L / R	1498	1557	-	1698	1738	1779	-	1858	-	-	-

H. 78

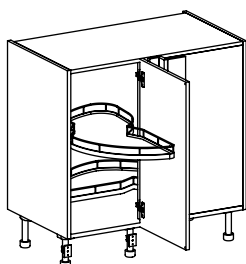

Base straight corner unit.
1 door.
2 Rotating drawers shelves.
1 corner filler with raised door profile,
4x4 cm.

Módulo bajo rinconero recto.
1 puerta.
2 Baldas giratorias y extraíbles.
1 regleta de rincón con perfil de puerta de
4x4 cm.

Modules bas encoignure droite.
1 porte.
2 Étagères pivotantes extractibles.
1 Fileur d'encoignure avec profilé de porte,
4x4 cm.

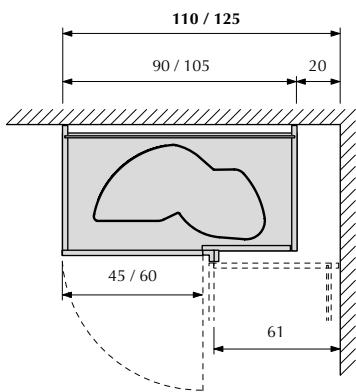

Availability / disponibilidad / disponibilité:

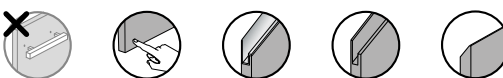

61 depth / profundidad / profondeur

SAP	Code Código Code	Width Ancho Largeur	Opening Apertura Ouverture	0	1	2	3	4	5	6	7	8	9	10
				700020814	BRR 0039	110	L / R	1387	1443	-	1571	1644	1693	-
700020816	BRR 0039	125	L / R	1498	1557	-	1698	1732	1790	-	1902	-	-	-

Base units
Módulos bajos
Modules Bas

Base unit with drawers
Módulo bajo con cajones
Module bas avec tiroirs

H. 78

Base unit with drawers.
1 deep drawer.
1 shelf.

Módulo bajo con cajones.
1 gaveta.
1 balda.

Modules bas avec tiroirs.
1 extractible.
1 étagère.

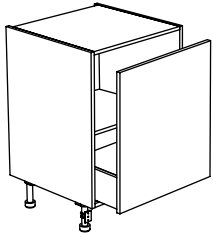

Availability / disponibilidad / disponibilité:

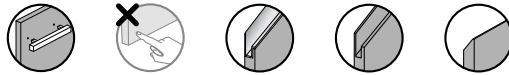

61 depth / profundidad / profondeur

SAP	Code Código Code	Width Ancho Largeur	Opening Apertura Ouverture											
				0	1	2	3	4	5	6	7	8	9	10
700020628	BE 0040	30	-	518	538	-	596	624	651	-	698	-	-	-
700020629	BE 0040	40	-	531	557	-	620	646	680	-	735	-	-	-
700020630	BE 0040	45	-	540	568	-	633	660	694	-	746	-	-	-
700020631	BE 0040	50	-	546	576	-	644	670	704	-	760	-	-	-
700020632	BE 0040	60	-	568	601	-	674	699	735	-	792	-	-	-
700020633	BE 0040	76,2	-	592	631	-	712	737	774	-	842	-	-	-

45 depth / profundidad / profondeur

SAP	Code Código Code	Width Ancho Largeur	Opening Apertura Ouverture											
				0	1	2	3	4	5	6	7	8	9	10
700020634	BE 0041	30	-	510	530	-	587	615	642	-	689	-	-	-
700020635	BE 0041	40	-	521	548	-	610	636	670	-	725	-	-	-
700020636	BE 0041	45	-	529	558	-	622	649	682	-	734	-	-	-
700020637	BE 0041	50	-	535	565	-	632	658	692	-	748	-	-	-
700020638	BE 0041	60	-	545	579	-	651	675	711	-	767	-	-	-
700020639	BE 0041	76,2	-	571	610	-	689	714	751	-	819	-	-	-

H. 78

Base unit with drawers.
1 deep drawer.
2 interior drawers.

Módulo bajo con cajones.
1 gaveta.
2 cajones interiores.

Modules bas avec tiroirs.
1 extractible.
2 tiroirs intérieurs.

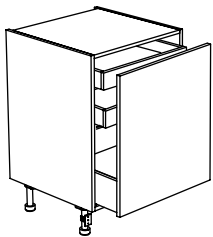

Availability / disponibilidad / disponibilité:

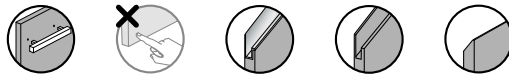

61 depth / profundidad / profondeur

SAP	Code Código Code	Width Ancho Largeur	Opening Apertura Ouverture											
				0	1	2	3	4	5	6	7	8	9	10
700020640	BE 0042	30	-	878	884	-	974	1001	1037	-	1099	-	-	-
700020641	BE 0042	40	-	898	909	-	1005	1041	1072	-	1132	-	-	-
700020642	BE 0042	45	-	910	923	-	1021	1048	1089	-	1142	-	-	-
700020643	BE 0042	50	-	919	934	-	1035	1061	1103	-	1160	-	-	-
700020644	BE 0042	60	-	937	955	-	1060	1095	1128	-	1192	-	-	-
700020645	BE 0042	76,2	-	977	999	-	1113	1149	1183	-	1259	-	-	-

45 depth / profundidad / profondeur

SAP	Code Código Code	Width Ancho Largeur	Opening Apertura Ouverture											
				0	1	2	3	4	5	6	7	8	9	10
700020646	BE 0043	30	-	875	880	-	970	997	1032	-	1093	-	-	-
700020647	BE 0043	40	-	895	907	-	1001	1027	1068	-	1127	-	-	-
700020648	BE 0043	45	-	906	919	-	1016	1043	1084	-	1136	-	-	-
700020649	BE 0043	50	-	914	929	-	1029	1055	1097	-	1153	-	-	-
700020650	BE 0043	60	-	931	949	-	1054	1089	1122	-	1186	-	-	-
700020651	BE 0043	76,2	-	967	990	-	1103	1138	1173	-	1249	-	-	-

Base units
Módulos bajos
Modules Bas

Base unit with drawers
Módulo bajo con cajones
Module bas avec tiroirs

H. 78

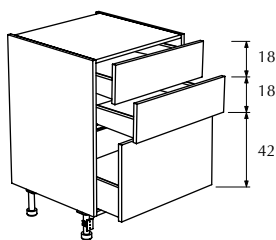

Base unit with drawers.
2 drawers.
1 deep drawer.

Módulo bajo con cajones.
2 cajones.
1 gaveta.

Modules bas avec tiroirs.
2 tiroirs.
1 extractible.

Availability / disponibilidad / disponibilité:

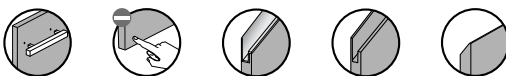

61 depth / profundidad / profondeur

SAP	Code Código Code	Width Ancho Largeur	Opening Apertura Ouverture											
				0	1	2	3	4	5	6	7	8	9	10
700020652	BCE 0044	30	-	840	909	-	1002	1069	1114	-	1190	-	-	-
700020653	BCE 0044	40	-	857	930	-	1029	1096	1141	-	1225	-	-	-
700020654	BCE 0044	45	-	868	943	-	1045	1113	1157	-	1246	-	-	-
700020655	BCE 0044	50	-	877	954	-	1058	1127	1171	-	1264	-	-	-
700020656	BCE 0044	60	-	893	985	-	1095	1157	1204	-	1316	-	-	-
700020657	BCE 0044	76,2	-	930	1031	-	1151	1223	1275	-	1391	-	-	-
700020658	BCE 0044	80	-	937	1040	-	1161	1227	1285	-	1405	-	-	-
700020659	BCE 0044	90	-	961	1068	-	1195	1263	1320	-	1448	-	-	-
700020660	BCE 0044	100	-	979	1090	-	1222	1293	1359	-	1484	-	-	-
700020661	BCE 0044	120	-	1028	1147	-	1291	1364	1429	-	1571	-	-	-

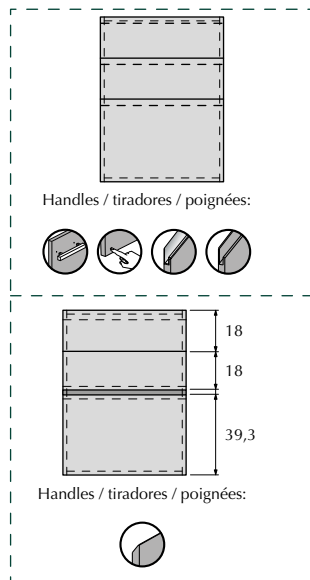

45 depth / profundidad / profondeur

SAP	Code Código Code	Width Ancho Largeur	Opening Apertura Ouverture											
				0	1	2	3	4	5	6	7	8	9	10
700020662	BCE 0045	30	-	837	905	-	998	1064	1109	-	1183	-	-	-
700020663	BCE 0045	40	-	855	927	-	1025	1092	1136	-	1219	-	-	-
700020664	BCE 0045	45	-	865	940	-	1040	1107	1151	-	1238	-	-	-
700020665	BCE 0045	50	-	872	949	-	1052	1120	1164	-	1255	-	-	-
700020666	BCE 0045	60	-	888	979	-	1089	1151	1198	-	1310	-	-	-
700020667	BCE 0045	76,2	-	920	1022	-	1140	1212	1264	-	1380	-	-	-
700020668	BCE 0045	80	-	926	1029	-	1150	1216	1274	-	1393	-	-	-
700020669	BCE 0045	90	-	956	1063	-	1190	1257	1314	-	1442	-	-	-
700020670	BCE 0045	100	-	971	1082	-	1214	1285	1351	-	1476	-	-	-
700020671	BCE 0045	120	-	1010	1130	-	1272	1345	1410	-	1551	-	-	-

H. 78

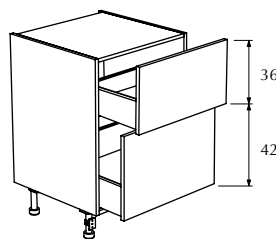

Base unit with drawers.
2 deep drawers.

Módulo bajo con cajones.
2 gavetas.

Modules bas avec tiroirs.
2 extractibles.

Availability / disponibilidad / disponibilité:

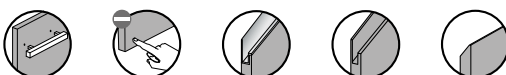

61 depth / profundidad / profondeur

SAP	Code Código Code	Width Ancho Largeur	Opening Apertura Ouverture											
				0	1	2	3	4	5	6	7	8	9	10
700020672	BE 0046	30	-	711	752	-	838	903	953	-	1026	-	-	-
700020673	BE 0046	40	-	724	769	-	860	925	975	-	1056	-	-	-
700020674	BE 0046	45	-	733	780	-	873	940	989	-	1074	-	-	-
700020675	BE 0046	50	-	734	782	-	876	943	996	-	1089	-	-	-
700020676	BE 0046	60	-	754	805	-	905	974	1025	-	1127	-	-	-
700020677	BE 0046	76,2	-	783	843	-	952	1030	1096	-	1193	-	-	-
700020678	BE 0046	80	-	788	850	-	960	1033	1104	-	1204	-	-	-
700020679	BE 0046	90	-	809	877	-	993	1070	1146	-	1255	-	-	-
700020680	BE 0046	100	-	822	894	-	1015	1097	1168	-	1286	-	-	-
700020681	BE 0046	120	-	863	942	-	1075	1158	1229	-	1337	-	-	-

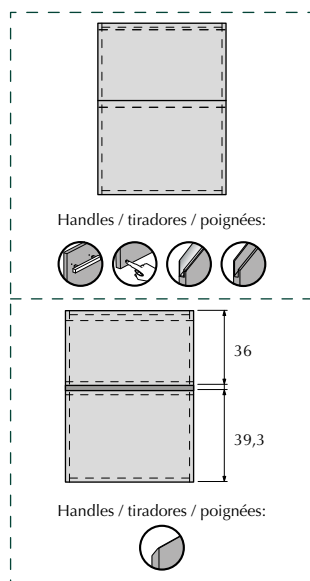

45 depth / profundidad / profondeur

SAP	Code Código Code	Width Ancho Largeur	Opening Apertura Ouverture											
				0	1	2	3	4	5	6	7	8	9	10
700020682	BE 0047	30	-	705	746	-	831	895	950	-	1021	-	-	-
700020683	BE 0047	40	-	719	763	-	853	918	972	-	1052	-	-	-
700020684	BE 0047	45	-	727	773	-	865	932	985	-	1069	-	-	-
700020685	BE 0047	50	-	733	781	-	875	942	995	-	1088	-	-	-
700020686	BE 0047	60	-	745	796	-	895	964	1015	-	1117	-	-	-
700020687	BE 0047	76,2	-	773	833	-	941	1020	1084	-	1181	-	-	-
700020688	BE 0047	80	-	777	839	-	949	1021	1092	-	1192	-	-	-
700020689	BE 0047	90	-	801	869	-	985	1062	1137	-	1246	-	-	-
700020690	BE 0047	100	-	812	885	-	1005	1087	1158	-	1275	-	-	-
700020691	BE 0047	120	-	844	924	-	1054	1138	1208	-	1316	-	-	-

Base units
Módulos bajos
Modules Bas

Base unit with drawers
Módulo bajo con cajones
Module bas avec tiroirs

H. 78

Base unit with drawers.
1 drawer.
1 deep drawer.

Módulo bajo con cajones.
1 cajón.
1 gaveta.

Modules bas avec tiroirs.
1 tiroir.
1 extractible.

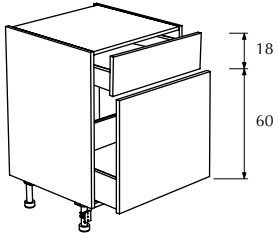

Availability / disponibilidad / disponibilité:

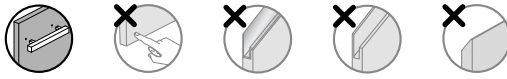

61 depth / profundidad / profondeur

SAP	Code Código Code	Width Ancho Largeur	Opening Apertura Ouverture											
				0	1	2	3	4	5	6	7	8	9	10
700020692	BCE 0048	30	-	728	766	-	830		898	-	-	-	-	-
700020693	BCE 0048	40	-	746	788	-	856		933	-	-	-	-	-
700020694	BCE 0048	45	-	757	801	-	872		953	-	-	-	-	-
700020695	BCE 0048	50	-	767	812	-	893		971	-	-	-	-	-
700020696	BCE 0048	60	-	792	845	-	931		1018	-	-	-	-	-
700020697	BCE 0048	76,2	-	830	888	-	983		1084	-	-	-	-	-
700020698	BCE 0048	80	-	837	896	-	994		1097	-	-	-	-	-
700020699	BCE 0048	90	-	863	926	-	1028		1141	-	-	-	-	-
700020700	BCE 0048	100	-	881	948	-	1055		1176	-	-	-	-	-
700020701	BCE 0048	120	-	932	1008	-	1126		1265	-	-	-	-	-

45 depth / profundidad / profondeur

SAP	Code Código Code	Width Ancho Largeur	Opening Apertura Ouverture											
				0	1	2	3	4	5	6	7	8	9	10
700020702	BCE 0049	30	-	725	763	-	827		895	-	-	-	-	-
700020703	BCE 0049	40	-	743	786	-	854		931	-	-	-	-	-
700020704	BCE 0049	45	-	754	798	-	868		950	-	-	-	-	-
700020705	BCE 0049	50	-	762	808	-	888		966	-	-	-	-	-
700020706	BCE 0049	60	-	778	832	-	918		1003	-	-	-	-	-
700020707	BCE 0049	76,2	-	812	871	-	965		1065	-	-	-	-	-
700020708	BCE 0049	80	-	818	879	-	974		1077	-	-	-	-	-
700020709	BCE 0049	90	-	850	913	-	1015		1127	-	-	-	-	-
700020710	BCE 0049	100	-	866	933	-	1039		1159	-	-	-	-	-
700020711	BCE 0049	120	-	906	983	-	1100		1237	-	-	-	-	-

H. 78

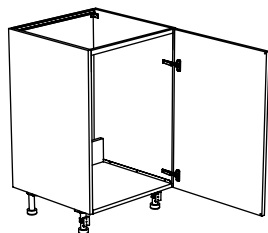

Base sink unit with door.
1 door.
1 protection mat.

Módulo bajo fregadero con puerta.
1 puerta.
1 base protectora.

Modules bas évier avec porte.
1 porte.
1 base de protection.

Availability / disponibilidad / disponibilité:

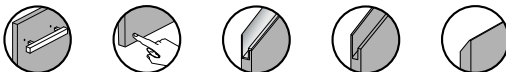

61 depth / profundidad / profondeur

SAP	Code Código Code	Width Ancho Largeur	Opening Apertura Ouverture	0	1	2	3	4	5	6	7	8	9	10
				700020712	BF 0050	45	L / R	316	354	-	400	426	456	-
700020713	BF 0050	50	L / R	320	360	-	411	433	464	-	508	-	-	-
700020714	BF 0050	60	L / R	335	378	-	435	455	487	-	539	-	-	-

H. 78

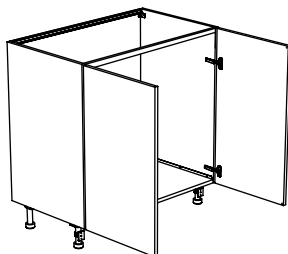

Base sink unit with door.
2 doors.
1 protection mat.

Módulo bajo fregadero con puerta.
2 puertas.
1 base protectora.

Modules bas évier avec porte.
2 portes.
1 base de protection.

Availability / disponibilidad / disponibilité:

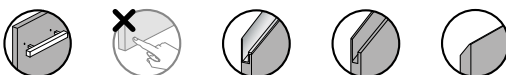

61 depth / profundidad / profondeur

SAP	Code Código Code	Width Ancho Largeur	Opening Apertura Ouverture	0	1	2	3	4	5	6	7	8	9	10
				700020715	BF 0051	76,2	-	365	439	-	507	558	600	-
700020716	BF 0051	80	-	367	449	-	520	567	615	-	690	-	-	-
700020717	BF 0051	90	-	379	465	-	540	588	641	-	717	-	-	-
700020718	BF 0051	100	-	386	475	-	554	601	656	-	740	-	-	-
700020719	BF 0051	120	-	411	507	-	596	639	699	-	797	-	-	-

H. 78

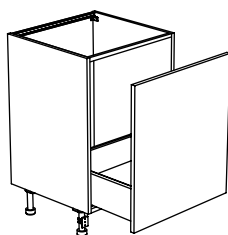

Base sink unit with deep drawer.
1 deep drawer.

Módulo bajo fregadero con gaveta.
1 gaveta.

Modules bas évier avec extractible.
1 extractible.

Availability / disponibilidad / disponibilité:

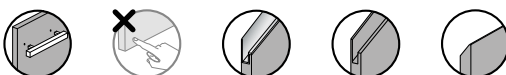

61 depth / profundidad / profondeur

SAP	Code Código Code	Width Ancho Largeur	Opening Apertura Ouverture	0	1	2	3	4	5	6	7	8	9	10
				700020720	BFC 0052	45	-	489	520	-	586	607	634	-
700020721	BFC 0052	50	-	495	527	-	590	616	638	-	691	-	-	-
700020722	BFC 0052	60	-	508	544	-	611	636	659	-	720	-	-	-

Base units
Módulos bajos
Modules Bas

Base sink unit
Módulo bajo fregadero
Module bas évier

H. 78

Base sink unit with deep drawer.
2 deep drawers.

Módulo bajo fregadero con gaveta.
2 gavetas.

Modules bas évier avec extractible.
2 extractibles.

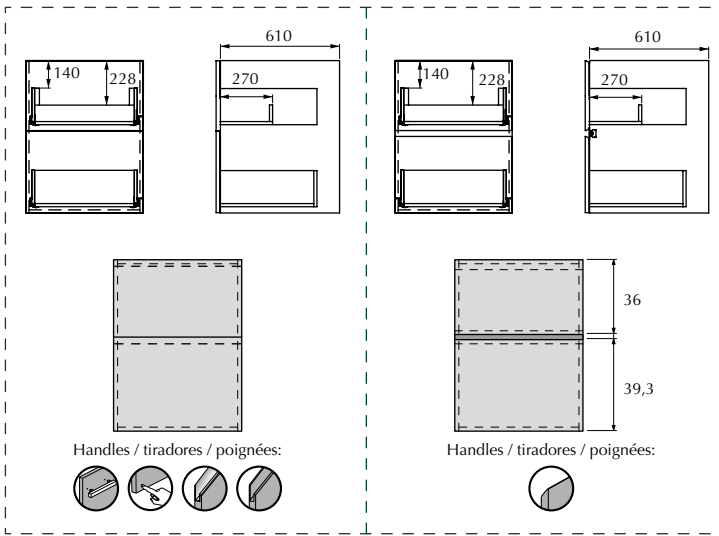
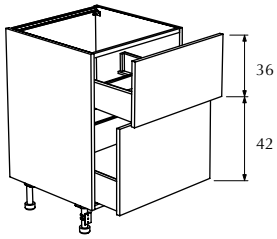

Availability / disponibilidad / disponibilité:

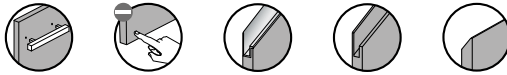

61 depth / profundidad / profondeur

SAP	Code Código Code	Width Ancho Largeur	Opening Apertura Ouverture											
				0	1	2	3	4	5	6	7	8	9	10
700020723	BFC 0053	60	-	831	880	-	987	1053	1116	-	1190	-	-	-
700020724	BFC 0053	90	-	883	948	-	1072	1146	1214	-	1312	-	-	-
700020725	BFC 0053	120	-	931	1007	-	1146	1228	1289	-	1411	-	-	-

H. 78

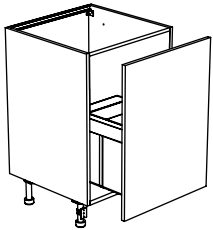

Base sink unit with waste sorting system.
1 deep drawer.
Waste containers

Módulo bajo fregadero y residuos.
1 extraíble.
Cubos de residuos.

Module bas évier et déchets.
1 extractible.
Poubelles.

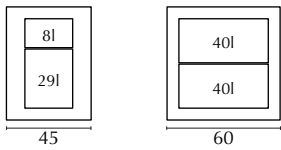

Availability / disponibilidad / disponibilité:

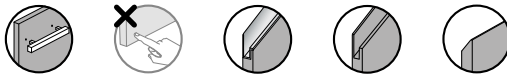

61 depth / profundidad / profondeur

SAP	Code Código Code	Width Ancho Largeur	Opening Apertura Ouverture											
				0	1	2	3	4	5	6	7	8	9	10
700020761	BFC 0062	45	-	1003	1018	-	1111	1147	1178	-	1229	-	-	-
700020763	BFC 0062	60	-	1068	1087	-	1191	1225	1259	-	1322	-	-	-

H. 78

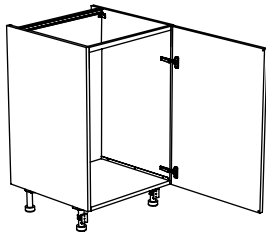

Base sink unit with door for USA.
1 door.
1 protection mat.
Full back panel.

Bajo fregadero con puerta para USA.
1 puerta.
1 base protectora.
Trasera completa.

Modules bas évier avec porte pour USA.
1 porte.
1 base de protection.
Panneau arrière complet.

Availability / disponibilidad / disponibilité:

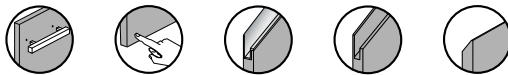

61 depth / profundidad / profondeur

SAP	Code Código Code	Width Ancho Largeur	Opening Apertura Ouverture	0	1	2	3	4	5	6	7	8	9	10
				700020787	BF 0070	45	L / R	322	359	-	406	432	462	-
700020788	BF 0070	50	L / R	326	365	-	414	440	470	-	510	-	-	-
700020789	BF 0070	60	L / R	342	385	-	438	463	495	-	542	-	-	-

H. 78

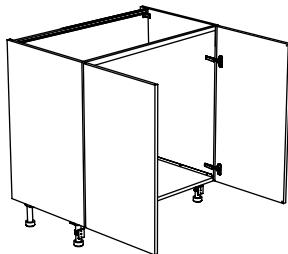

Base sink unit with door for USA.
2 doors.
1 protection mat.
Full back panel.

Bajo fregadero con puerta para USA.
2 puertas.
1 base protectora.
Trasera completa.

Modules bas évier avec porte pour USA.
2 portes.
1 base de protection.
Panneau arrière complet.

Availability / disponibilidad / disponibilité:

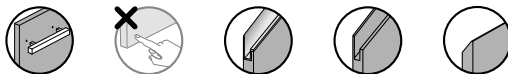

61 depth / profundidad / profondeur

SAP	Code Código Code	Width Ancho Largeur	Opening Apertura Ouverture	0	1	2	3	4	5	6	7	8	9	10
				700020790	BF 0071	76,2	-	374	448	-	517	557	599	-
700020791	BF 0071	80	-	376	458	-	530	576	620	-	687	-	-	-
700020792	BF 0071	90	-	391	477	-	553	601	643	-	717	-	-	-
700020793	BF 0071	100	-	399	488	-	568	615	658	-	740	-	-	-
700020794	BF 0071	120	-	426	522	-	612	656	702	-	791	-	-	-

H. 78

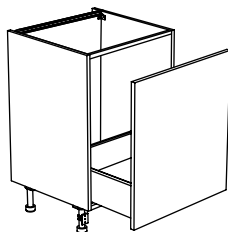

Base sink unit with deep drawer for USA.
1 deep drawer.
Full back panel.

Bajo fregadero con gaveta para USA.
1 gaveta.
Trasera completa.

Modules bas évier avec extractible pour USA.
1 extractible.
Panneau arrière complet.

Availability / disponibilidad / disponibilité:

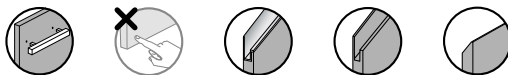

61 depth / profundidad / profondeur

SAP	Code Código Code	Width Ancho Largeur	Opening Apertura Ouverture	0	1	2	3	4	5	6	7	8	9	10
				700020795	BFC 0072	45	-	495	525	-	587	619	646	-
700020796	BFC 0072	50	-	501	533	-	597	628	656	-	697	-	-	-
700020797	BFC 0072	60	-	515	551	-	619	649	679	-	728	-	-	-

Base units
Módulos bajos
Modules Bas

Base sink unit for USA
Módulo bajo fregadero para USA
Module bas évier pour USA

H. 78

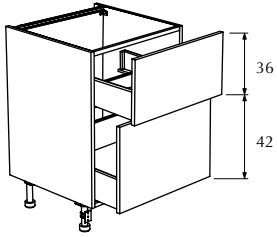

Base sink unit with deep drawer for USA.
2 deep drawers.
Full back panel.

Bajo fregadero con gaveta para USA.
2 gavetas.
Trasera completa.

Modules bas évier avec extractible pour USA.
2 extractibles.
Panneau arrière complet.

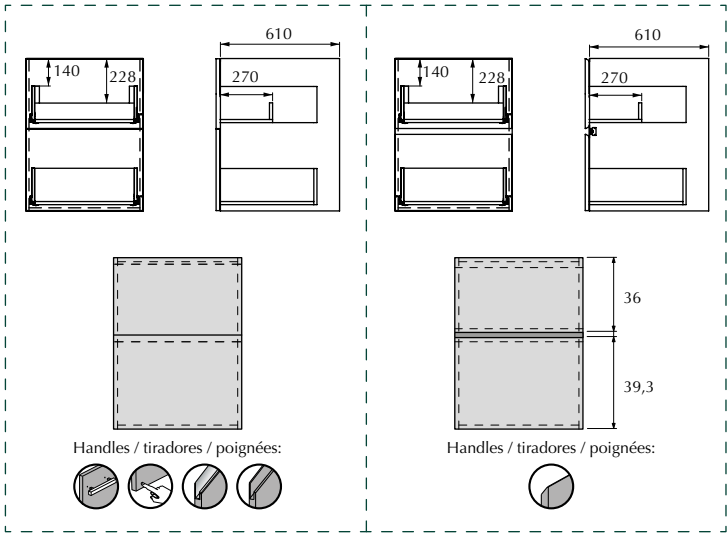

Availability / disponibilidad / disponibilité:

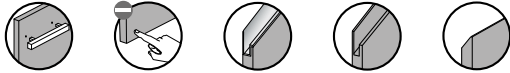

61 depth / profundidad / profondeur

SAP	Code Código Code	Width Ancho Largeur	Opening Apertura Ouverture											
				0	1	2	3	4	5	6	7	8	9	10
700020798	BFC 0073	60	-	803	852	-	957	1024	1076	-	1159	-	-	-
700020799	BFC 0073	90	-	855	921	-	1042	1117	1173	-	1281	-	-	-
700020800	BFC 0073	120	-	901	978	-	1114	1197	1257	-	1352	-	-	-

H. 78

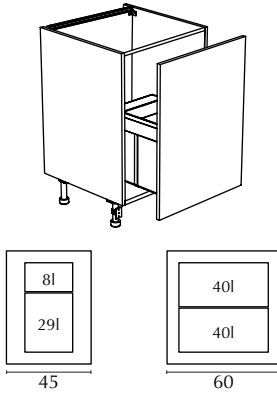

Base sink unit with waste sorting system for USA.
1 deep drawer.
Waste containers.
Full back panel.

Módulo bajo fregadero y residuos para USA.
1 extraíble.
Cubos de residuos.
Trasera completa.

Module bas évier et déchets pour USA.
1 extractible.
Poubelles.
Panneau arrière complet.

Availability / disponibilidad / disponibilité:

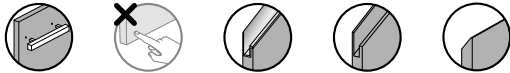

61 depth / profundidad / profondeur

SAP	Code Código Code	Width Ancho Largeur	Opening Apertura Ouverture											
				0	1	2	3	4	5	6	7	8	9	10
700020801	BFC 0074	45	-	860	875	-	968	1004	1035	-	1086	-	-	-
700020803	BFC 0074	60	-	926	944	-	1048	1093	1116	-	1158	-	-	-

H. 78

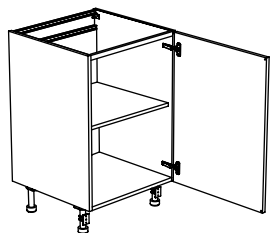

Base unit for hob with door.
1 door.
1 shelf.
Back panel with a gap for appliances ventilation.

Módulo bajo para placa con puerta.
1 puerta.
1 balda.
Trasera con hueco para ventilación de electrodomésticos.

Module bas pour plaque avec porte.
1 porte.
1 étagère.
Panneau arrière avec espace pour aération des électroménagers.

Availability / disponibilidad / disponibilité:

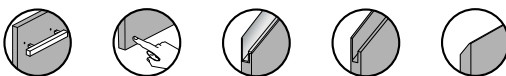

61 depth / profundidad / profondeur

SAP	Code Código Code	Width Ancho Largeur	Opening Apertura Ouverture	61 depth / profundidad / profondeur										
				0	1	2	3	4	5	6	7	8	9	10
700020726	BPL 0054	40	L / R	320	356	-	401	426	452	-	493	-	-	-
700020727	BPL 0054	45	L / R	324	361	-	408	434	459	-	504	-	-	-
700020728	BPL 0054	50	L / R	330	369	-	418	443	469	-	518	-	-	-
700020729	BPL 0054	60	L / R	350	392	-	446	479	498	-	544	-	-	-

H. 78

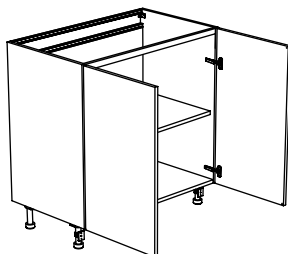

Base unit for hob with doors.
2 doors.
1 shelf.
Back panel with a gap for appliances ventilation.

Módulo bajo para placa con puertas.
2 puertas.
1 balda.
Trasera con hueco para ventilación de electrodomésticos.

Module bas pour plaque avec portes.
2 portes.
1 étagère.
Panneau arrière avec espace pour aération des électroménagers.

Availability / disponibilidad / disponibilité:

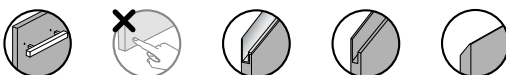

61 depth / profundidad / profondeur

SAP	Code Código Code	Width Ancho Largeur	Opening Apertura Ouverture	61 depth / profundidad / profondeur										
				0	1	2	3	4	5	6	7	8	9	10
700020730	BPL 0055	76,2	-	382	456	-	526	576	619	-	672	-	-	-
700020731	BPL 0055	80	-	386	468	-	540	587	642	-	710	-	-	-
700020732	BPL 0055	90	-	399	484	-	561	609	663	-	739	-	-	-
700020733	BPL 0055	100	-	408	496	-	577	624	680	-	764	-	-	-
700020734	BPL 0055	120	-	459	544	-	626	678	729	-	828	-	-	-

H. 78

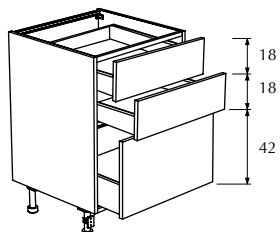

Base unit for hob with door.
2 drawers.
1 deep drawer.
Back panel with a gap for appliances ventilation.

Módulo bajo para placa con puerta.
2 cajones.
1 gaveta.
Trasera con hueco para ventilación de electrodomésticos.

Module bas pour plaque avec porte.
2 tiroirs.
1 extractible.
Panneau arrière avec espace pour aération des électroménagers.

Availability / disponibilidad / disponibilité:

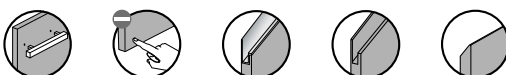

61 depth / profundidad / profondeur

SAP	Code Código Code	Width Ancho Largeur	Opening Apertura Ouverture	61 depth / profundidad / profondeur										
				0	1	2	3	4	5	6	7	8	9	10
700020735	BPL 0056	40	-	837	902	-	1006	1093	1138	-	1211	-	-	-
700020736	BPL 0056	45	-	844	912	-	1018	1106	1150	-	1227	-	-	-
700020737	BPL 0056	50	-	854	923	-	1032	1121	1165	-	1246	-	-	-
700020738	BPL 0056	60	-	879	954	-	1069	1163	1210	-	1300	-	-	-
700020739	BPL 0056	76,2	-	917	1002	-	1127	1231	1273	-	1351	-	-	-
700020740	BPL 0056	80	-	924	1010	-	1137	1236	1284	-	1365	-	-	-
700020741	BPL 0056	90	-	950	1039	-	1172	1274	1320	-	1409	-	-	-
700020742	BPL 0056	100	-	966	1060	-	1198	1303	1346	-	1442	-	-	-
700020743	BPL 0056	120	-	1016	1117	-	1267	1376	1417	-	1500	-	-	-

Handles / tiradores / poignées:



Handles / tiradores / poignées:



Base units
Módulos bajos
Modules Bas

Base unit for hob
Módulo bajo para placa de cocción
Module bas pour plaque de cuisson

H. 78

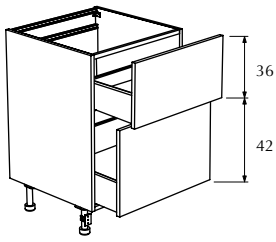

Base unit for hob with door.
2 deep drawers.
Back panel with a gap for appliances ventilation.

Módulo bajo para placa con puerta.
2 gavetas.
Trasera con hueco para ventilación de electrodomésticos.

Module bas pour plaque avec porte.
2 extractibles.
Panneau arrière avec espace pour aération des électroménagers.

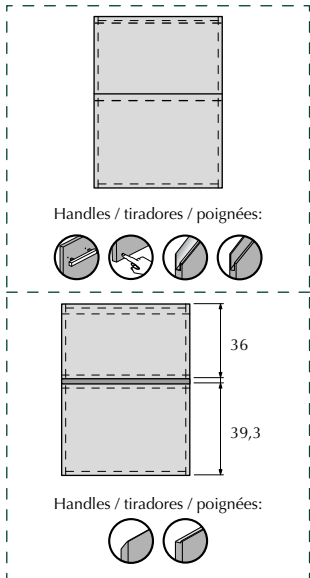

Availability / disponibilidad / disponibilité:

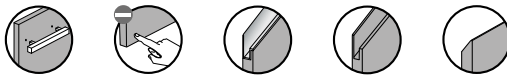

61 depth / profundidad / profondeur

SAP	Code Código Code	Width Ancho Largeur	Opening Apertura Ouverture											
				0	1	2	3	4	5	6	7	8	9	10
700020744	BPL 0057	40	-	705	750	-	838	921	975	-	1042	-	-	-
700020745	BPL 0057	45	-	710	757	-	848	931	985	-	1055	-	-	-
700020746	BPL 0057	50	-	718	767	-	860	944	997	-	1072	-	-	-
700020747	BPL 0057	60	-	739	791	-	890	976	1028	-	1111	-	-	-
700020748	BPL 0057	76,2	-	770	831	-	939	1036	1082	-	1156	-	-	-
700020749	BPL 0057	80	-	776	838	-	947	1038	1091	-	1168	-	-	-
700020750	BPL 0057	90	-	797	866	-	982	1077	1134	-	1219	-	-	-
700020751	BPL 0057	100	-	809	882	-	1002	1103	1155	-	1236	-	-	-
700020752	BPL 0057	120	-	851	931	-	1062	1167	1216	-	1324	-	-	-

Base units
Módulos bajos
Modules Bas

Base unit for hob and oven
Módulo bajo para placa de cocción y horno
Module bas pour plaque de cuisson et four

H. 78

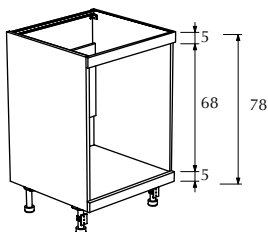

Base unit for oven / microwave.
1 installation space , 68 cm high.
2 fillers, 5 cm height

Módulo bajo para horno/ microondas.
1 hueco integración de 68 cm.
2 regletas de 5 cm de alto.

Module bas pour four / micro-ondes.
1 espace d'intégration de 68 cm.
2 fileurs, 5 cm d'hauteur.

61 depth / profundidad / profondeur

SAP	Code Código Code	Width Ancho Largeur	Opening Apertura Ouverture	0	1	2	3	4	5	6	7	8	9	10
				700020753	BH 0058	60	-	319	391	-	437	466	481	-
700020754	BH 0058	76,2	-	333	410	-	459	491	503	-	529	-	-	-
700020755	BH 0058	90	-	356	437	-	489	521	535	-	564	-	-	-

H. 78

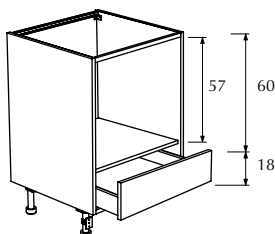

Base unit for oven / microwave.
1 drawer.
1 installation space , 57 cm high.

Módulo bajo para horno/ microondas.
1 cajón.
1 hueco integración de 57 cm.

Module bas pour four / micro-ondes.
1 tiroir.
1 espace d'intégration de 57 cm.

Availability / disponibilidad / disponibilité:

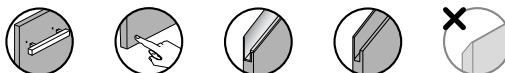

61 depth / profundidad / profondeur

SAP	Code Código Code	Width Ancho Largeur	Opening Apertura Ouverture	0	1	2	3	4	5	6	7	8	9	10
				700020759	BH 0059	60	-	491	505	-	560	592	609	-
700020757	BH 0059	76,2	-	512	528	-	587	622	636	-	660	-	-	-
700020758	BH 0059	90	-	540	555	-	618	652	668	-	695	-	-	-

Base units
Módulos bajos
Modules Bas

Base unit with special fittings
Módulo bajo con herraje especial
Module bas avec ferrures spécials

H. 78

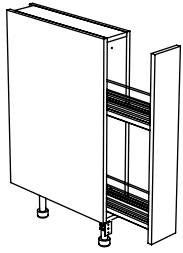

Base unit with bottle rack.
1 Pull-out.
2 Metal trays.
Opening indicates the side where bottles are introduced.

Módulo bajo botellero.
1 Frente extraíble.
2 Bandejas metálicas.
La apertura indica por dónde se introducen las botellas.

Module bas porte-bouteilles.
1 Façade extractible.
2 Plateaux métalliques.
L'ouverture indique le côté où les bouteilles sont introduits.

Availability / disponibilidad / disponibilité:

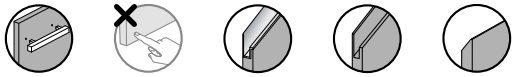

61 depth / profundidad / profondeur

SAP	Code Código Code	Width Ancho Largeur	Opening Apertura Ouverture	0	1	2	3	4	5	6	7	8	9	10
				700020759	BEQ 0060	15	L/R	679	687	-	754	784	811	-

H. 78

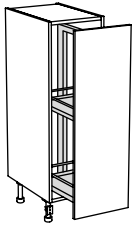

Base larder unit.
1 Pull-out.
2 Adjustable metal baskets.

Módulo bajo provisiones.
1 Frente extraíble.
2 Cestas metálicas regulables.

Module bas provisions.
1 Façade extractible.
2 Paniers métalliques réglables.

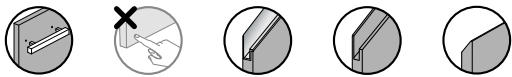

Availability / disponibilidad / disponibilité:



61 depth / profundidad / profondeur

SAP	Code Código Code	Width Ancho Largeur	Opening Apertura Ouverture	0	1	2	3	4	5	6	7	8	9	10
				700020760	BEQ 0061	30	-	649	664	-	733	760	791	-

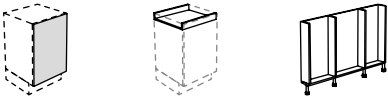
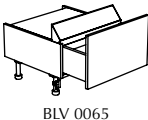
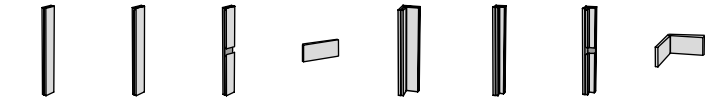
Complements for base unit
Complementos para módulo bajo
Compléments pour module bas

Type of unit Tipo de módulo Type de module	Available measures Medidas disponibles Dimensions disponibles	Available units Módulos disponibles Modules disponibles
<p>p.82 Complements, 78 cm. height Complementos, altura 78 cm. Compléments, hauteur 78 cm.</p>	Width / Ancho / Largeur (cm.): 60 (FE)	 <p>FE 0063 FE 0075 BAUX 0064</p>
<p>p.82 Base unit for dishwasher in a tower unit Módulo base para lavavajillas en columna Module bas pour lave-vaisselle en colonne</p>	Depth / Profundidad / Profondeur (cm.): 61 Width / Ancho / Largeur (cm.): 60	 <p>BLV 0065</p>
<p>p.83 - 84 Fillers Regletas Fileursne</p>	Height / Altura / Hauteur (cm.): 18 - 42 - 60 - 78	 <p>BRE 0850 BRE 0851 BRE 0852 BRE 0853 BRE 0854 BRE 0855 BRE 0856 BRE 979</p>
<p>p.85 Decorative side panels Paneles decorativos Panneaux décoratifs</p>	Depth / Profundidad / Profondeur (cm.): 35 - 45 - 61 Height / Altura / Hauteur (cm.): (BPD) 18 - 42 - 60 - 78 (BCA) 28 - 30 - 52 - 54 - 70 - 72 - 88 - 90	 <p>BPD 0857 - 0858 - 0859 BCA 0860 - 0861 - 0862 - 0863 - 0864 - 0865</p>
<p>p.86 - 87 Comp. for models with integrated handle Comp. para modelos con tirador integrado Comp. pour modèles avec poignée intégrée</p>		 <p>BSA 0866 BSA 0867 BSA 0868 BSA 0869</p>

Base units
Módulos bajos
Modules Bas

Complements, 78 cm. height
Complementos, altura 78 cm.
Compléments, hauteur 78 cm.

H. 78

Front for integrated appliances.

Frente para electrodomésticos integrados.

Façade pour électroménagers intégrés.

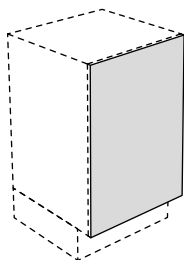

Availability / disponibilidad / disponibilité:

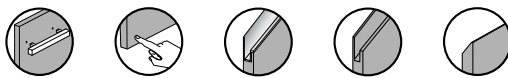

61 depth / profundidad / profondeur

SAP	Code Código Code	Width Ancho Largeur	Opening Apertura Ouverture	0	1	2	3	4	5	6	7	8	9	10
700020764	FE 0063	45	-	-	66	-	86	112	135	-	170	-	-	-
700020765	FE 0063	60	-	-	72	-	97	121	147	-	190	-	-	-
700020766	FE 0063	61	-	-	72	-	98	127	148	-	190	-	-	-

H. 78

Supplement for dishwasher installation when dishwasher is not XL size.

Suplemento para la instalación del lavavajillas cuando el aparato no es de tamaño XL.

Supplément pour l'installation du lave-vaisselle lorsque l'appareil n'est pas de taille XL.

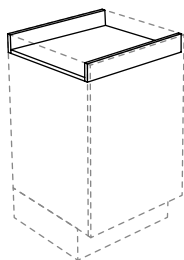

61 depth / profundidad / profondeur

SAP	Height Altura Hauteur	R1	R2	R3
700020817	45	FEL 0075 119	FER 0075 132	FEE 0075 181
700020818	60	FEL 0075 130	FER 0075 145	FEE 0075 210
700020819	61	FEL 0075 131	FER 0075 145	FEE 0075 212

H. 78

Auxiliary structure to increase the island depth.
Carcass finish.
Intermediate partition pieces served separately.
Price per linear metre, maximum width 200 cm.

Estructura auxiliar para suplementar fondo de islas.
Acabado de casco.
Los separadores intermedios se envían sueltos.
Precio por metro lineal, ancho máximo 200 cm.

Structure auxiliaire pour augmenter la profondeur de l'îlot.
Finitions de caisson.
Les sépareurs intermédiaires sont fournis séparément.
Prix par mètre linéaire, largeur maximale 200 cm.

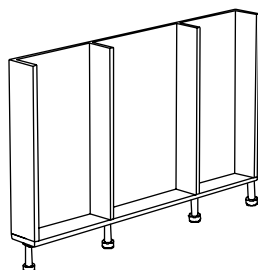

SAP	Code Código Code	Depth Profundidad Profondeur	Carcass finish Acabado casco Finition caisson
700020767	BAUX 0064	15	290
700020768	BAUX 0064	20	303
700020769	BAUX 0064	25	325

Base units
Módulos bajos
Modules Bas

Base unit for dishwasher in a tower unit
Módulo base para lavavajillas en columna
Module bas pour lave-vaisselle en colonne

Base unit for dishwasher in a tower unit.
1 deep drawer.
1 water collecting tray.

Módulo base para lavavajillas en columna.
1 extraíble.
1 bandeja recogeaguas.

Module bas pour lave-vaisselle en colonne.
1 extractible.
1 plateau dévidoir.

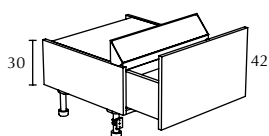

Availability / disponibilidad / disponibilité:

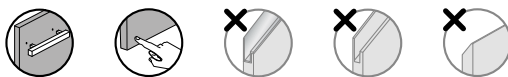

61 depth / profundidad / profondeur

SAP	Code Código Code	Width Ancho Largeur	Opening Apertura Ouverture	0	1	2	3	4	5	6	7	8	9	10
700020770	BLV 0065	60	-	-	518	-	602	-	659	-	-	-	-	-

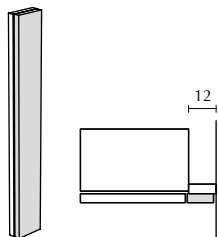

Front filler piece.
Plain design.
Width, 12 cm.

Regleta de ajuste.
Diseño liso.
Ancho, 12 cm.

Fileur d'ajustement.
Modèle lisse.
Largeur, 12 cm.

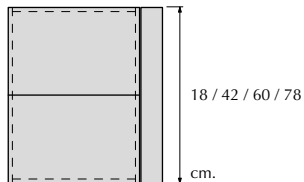

12 width / ancho / largeur

SAP	Code Código Code	Height Altura Hauteur	Position Posición Position											
				0	1	2	3	4	5	6	7	8	9	10
700022081	BRE 0850	18	-	-	63	-	69	-	73	-	-	-	-	-
700022083	BRE 0850	42	-	-	69	-	77	-	83	-	-	-	-	-
700022085	BRE 0850	60	-	-	74	-	83	-	91	-	-	-	-	-
700022087	BRE 0850	78	-	-	78	-	88	-	97	-	-	-	-	-

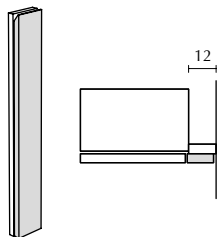

Front filler piece with raised door profile.
Plain design.
Width, 12 cm.

Regleta de ajuste con perfil de puerta.
Diseño liso.
Ancho, 12 cm.

Fileur d'ajustement avec profilé de porte.
Modèle lisse.
Largeur, 12 cm.

Availability / disponibilidad / disponibilité:

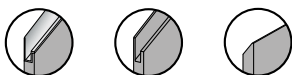

12 width / ancho / largeur

SAP	Code Código Code	Height Altura Hauteur	Position Posición Position											
				0	1	2	3	4	5	6	7	8	9	10
700022099	BRE 0851	18	-	-	-	-	-	117	124	-	126	-	-	-
700022102	BRE 0851	42	-	-	-	-	-	124	132	-	134	-	-	-
700022105	BRE 0851	60	-	-	-	-	-	128	138	-	142	-	-	-
700022109	BRE 0851	78	-	-	-	-	-	133	143	-	150	-	-	-

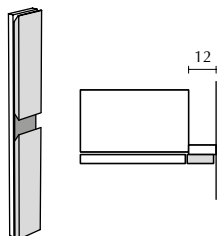

Front filler piece with raised door profile.
For compositions with middle side profile.
It requires horizontal profile (BRE 0853).
Width, 12 cm.

Regleta de ajuste con perfil de puerta.
Para composiciones con perfil intermedio.
Requiere perfil horizontal (BRE 853).
Ancho, 12 cm.

Fileur d'ajustement avec profilé de porte.
Pour compositions avec profilé intermédiaire.
Il nécessite profil horizontal (BRE 0853).
Largeur, 12 cm.

Availability / disponibilidad / disponibilité:

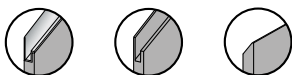

12 width / ancho / largeur

SAP	Code Código Code	Height Altura Hauteur	Position Posición Position											
				0	1	2	3	4	5	6	7	8	9	10
700022116	BRE 0852	60	-	-	-	-	-	227	257	-	259	-	-	-
700022117	BRE 0852	78	-	-	-	-	-	232	263	-	267	-	-	-

Horizontal profile for filler.
Aluminium profile.
Steel profile finish.
Width, 12 cm.

Perfil horizontal para regleta.
Perfil de aluminio.
Acabado del perfil en acero.
Ancho, 12 cm.

Profil horizontal pour fileur.
Profil en aluminium.
Finition du profil en acier.
Largeur, 12 cm.

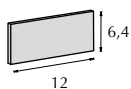

12 width / ancho / largeur

SAP	Code Código Code	Height Altura Hauteur	Position Posición Position	Steel finish
				Acabado acero Finition acier
700022118	BRE 0853	6,5	-	34

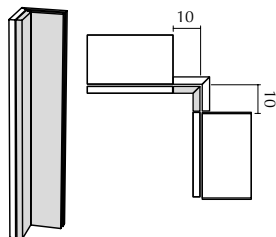

Corner filler piece for 90° solution.
Plain design.
Distance between units, 10x10 cm.

Regleta de rincón, ángulo 90°.
Diseño liso.
Distancia entre módulos, 10x10 cm.

Fileur d'encoignure, angle 90°.
Modèle lisse.
Distance entre modules, 10x10 cm.

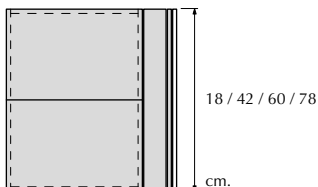

10 width / ancho / largeur

SAP	Code Código Code	Height Altura Hauteur	Position Posición Position											
				0	1	2	3	4	5	6	7	8	9	10
700022119	BRE 0854	18	-	-	93	-	103	-	110	-	-	-	-	-
700022122	BRE 0854	42	-	-	105	-	119	-	130	-	-	-	-	-
700022125	BRE 0854	60	-	-	113	-	130	-	146	-	-	-	-	-
700022129	BRE 0854	78	-	-	121	-	141	-	162	-	-	-	-	-

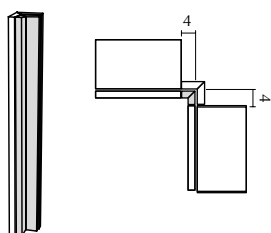

Corner filler piece for 90° solution.
With raised door profile.
Distance between units, 4x4 cm.

Regleta de rincón, ángulo 90°.
Con perfil de puerta.
Distancia entre módulos, 4x4 cm.

Fileur d'encoignure, angle 90°.
Avec profilé de porte.
Distance entre modules, 4x4 cm.

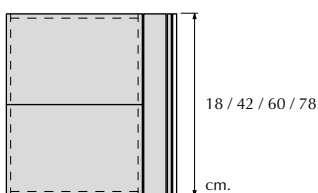

10 width / ancho / largeur

SAP	Code Código Code	Height Altura Hauteur	Position Posición Position											
				0	1	2	3	4	5	6	7	8	9	10
700022144	BRE 0855	18	-	-	89	-	99	135	138	-	142	-	-	-
700022147	BRE 0855	42	-	-	101	-	115	152	157	-	169	-	-	-
700022150	BRE 0855	60	-	-	109	-	126	162	169	-	185	-	-	-
700022154	BRE 0855	78	-	-	117	-	137	171	180	-	201	-	-	-

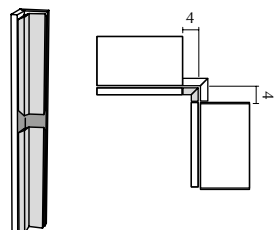

Corner filler piece for 90° solution.
With raised door profile.
For compositions with middle side profile.
It requires horizontal profile (BRE 0856).
Distance between units, 4x4 cm.

Regleta de rincón, ángulo 90°.
Con perfil de puerta.
Para composiciones con perfil intermedio.
Requiere perfil horizontal (BRE 856).
Distancia entre módulos, 4x4 cm.

Fileur d'encoignure, angle 90°.
Avec profilé de porte.
Pour compositions avec profilé intermédiaire.
Il nécessite profil horizontal (BRE 0856).
Distance entre modules, 4x4 cm.

Availability / disponibilidad / disponibilité:

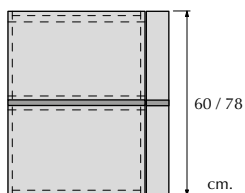
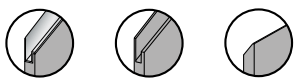

4 width / ancho / largeur

SAP	Code Código Code	Height Altura Hauteur	Position Posición Position											
				0	1	2	3	4	5	6	7	8	9	10
700022169	BRE 0856	60	-	-	-	-	-	323	324	-	334	-	-	-
700022170	BRE 0856	78	-	-	-	-	-	335	341	-	355	-	-	-

Horizontal profile for corner filler.
Aluminium profile.
Steel profile finish.

Perfil horizontal para regleta de rincón.
Perfil de aluminio.
Acabado del perfil en acero.

Profil horizontal pour fileur encoignure.
Profil en aluminium.
Finition du profil en acier.

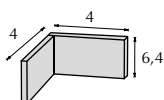

4 width / ancho / largeur

SAP	Code Código Code	Height Altura Hauteur	Position Posición Position	Steel finish
				Acabado acero Finition acier
700022171	BRE 0979	6,5	-	53

Decorative side panel.
Panel thickness, 19 mm.
On level with front.

Panel decorativo.
Espesor de panel, 19 mm.
A ras de frente.

Panneau décoratif.
Épaisseur du panneau, 19 mm.
Au ras de façade.

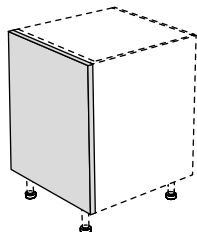

61 depth / profundidad / profondeur

SAP	Height Altura Hauteur	R1		R2		R3	
		Code	Value	Code	Value	Code	Value
700022172	18	BPDL 0857	33	BPDR 0857	43	BPDE 0857	51
700022175	42	BPDL 0857	41	BPDR 0857	58	BPDE 0857	79
700022178	60	BPDL 0857	49	BPDR 0857	72	BPDE 0857	102
700022182	78	BPDL 0857	55	BPDR 0857	84	BPDE 0857	123

45 depth / profundidad / profondeur

SAP	Height Altura Hauteur	R1		R2		R3	
		Code	Value	Code	Value	Code	Value
700022197	18	BPDL 0858	30	BPDR 0858	38	BPDE 0858	44
700022200	42	BPDL 0858	37	BPDR 0858	51	BPDE 0858	66
700022203	60	BPDL 0858	42	BPDR 0858	60	BPDE 0858	82
700022207	78	BPDL 0858	49	BPDR 0858	71	BPDE 0858	100

35 depth / profundidad / profondeur

SAP	Height Altura Hauteur	R1		R2		R3	
		Code	Value	Code	Value	Code	Value
700022222	18	BPDL 0859	29	BPDR 0859	36	BPDE 0859	40
700022225	42	BPDL 0859	35	BPDR 0859	47	BPDE 0859	58
700022228	60	BPDL 0859	38	BPDR 0859	54	BPDE 0859	71
700022232	78	BPDL 0859	42	BPDR 0859	61	BPDE 0859	83

Support side panels.
Panel thickness, 19 mm.
On level with front.

Costado de apoyo.
Espesor de panel, 19 mm.
A ras de frente.

Côtés de soutien.
Épaisseur du panneau, 19 mm.
Au ras de façade.

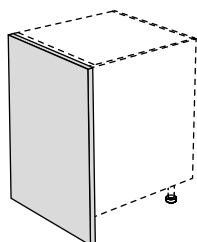

61 depth / profundidad / profondeur

SAP	Unit height Altura módulo Hauteur module	Plinth Zócalo Plinthe	Total height Altura total Hauteur totale	R1		R2		R3	
				Code	Value	Code	Value	Code	Value
700022247	18	10	28	BCAL 0860	39	BCAR 0860	52	BCAE 0860	65
700022256		12	30	BCAL 0861	40	BCAR 0861	54	BCAE 0861	67
700022248	42	10	52	BCAL 0860	50	BCAR 0860	71	BCAE 0860	96
700022257		12	54	BCAL 0861	51	BCAR 0861	73	BCAE 0861	99
700022249	60	10	70	BCAL 0860	56	BCAR 0860	83	BCAE 0860	117
700022258		12	72	BCAL 0861	57	BCAR 0861	84	BCAE 0861	120
700022250	78	10	88	BCAL 0860	62	BCAR 0860	95	BCAE 0860	138
700022259		12	90	BCAL 0861	63	BCAR 0861	96	BCAE 0861	141

45 depth / profundidad / profondeur

SAP	Unit height Altura módulo Hauteur module	Plinth Zócalo Plinthe	Total height Altura total Hauteur totale	R1		R2		R3	
				Code	Value	Code	Value	Code	Value
700022265	18	10	28	BCAL 0862	36	BCAR 0862	48	BCAE 0862	57
700022274		12	30	BCAL 0863	37	BCAR 0863	48	BCAE 0863	58
700022266	42	10	52	BCAL 0862	42	BCAR 0862	59	BCAE 0862	78
700022275		12	54	BCAL 0863	43	BCAR 0863	60	BCAE 0863	79
700022267	60	10	70	BCAL 0862	50	BCAR 0862	72	BCAE 0862	97
700022276		12	72	BCAL 0863	51	BCAR 0863	73	BCAE 0863	99
700022268	78	10	88	BCAL 0862	55	BCAR 0862	81	BCAE 0862	113
700022277		12	90	BCAL 0863	55	BCAR 0863	82	BCAE 0863	115

35 depth / profundidad / profondeur

SAP	Unit height Altura módulo Hauteur module	Plinth Zócalo Plinthe	Total height Altura total Hauteur totale	R1		R2		R3	
				Code	Value	Code	Value	Code	Value
700022283	18	10	28	BCAL 0864	35	BCAR 0864	45	BCAE 0864	51
700022292		12	30	BCAL 0865	35	BCAR 0865	45	BCAE 0865	53
700022284	42	10	52	BCAL 0864	40	BCAR 0864	54	BCAE 0864	68
700022293		12	54	BCAL 0865	40	BCAR 0865	55	BCAE 0865	70
700022285	60	10	70	BCAL 0864	43	BCAR 0864	61	BCAE 0864	81
700022294		12	72	BCAL 0865	44	BCAR 0865	62	BCAE 0865	82
700022286	78	10	88	BCAL 0864	50	BCAR 0864	72	BCAE 0864	97
700022295		12	90	BCAL 0865	51	BCAR 0865	73	BCAE 0865	98

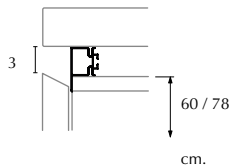
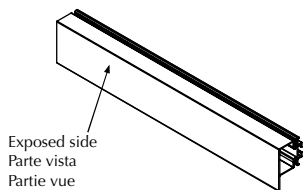

Horizontal spacer panel upper profile for base units with a flap on the front.
Steel profile finish.
Price per linear metre.
It requires one BS - element per each 90° profile union.

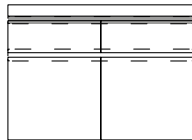

Perfil separador horizontal superior para módulos bajos con solapa.
Acabado del perfil en acero.
Precio por metro lineal.
Requiere una pieza BS - por cada unión en ángulo.

Profile séparateur horizontal supérieur pour modules bas avec rabat.
Finition du profil en acier.
Prix par metre lineaire.
Il est nécessaire une élément BS - per chaque fixation à 90°.

SAP	Code Código Code	Height Altura Hauteur	Position Posición Position	Steel finish Acabado acero Finition acier
700022301	BSA 0866	2,5	-	73

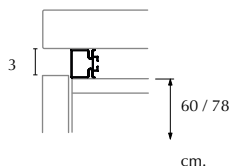
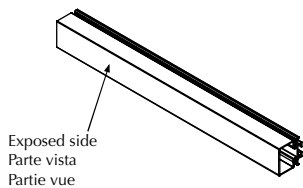

Horizontal spacer panel upper profile for base units.
Steel profile finish.
Price per linear metre.
It requires one BS - element per each 90° profile union.

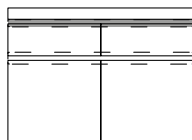

Perfil separador horizontal superior para módulos bajos.
Acabado del perfil en acero.
Precio por metro lineal.
Requiere una pieza BS - por cada unión en ángulo.

Profile séparateur horizontal supérieur pour modules bas.
Finition du profil en acier.
Prix par metre lineaire.
Il est nécessaire une élément BS - per chaque fixation à 90°.

SAP	Code Código Code	Height Altura Hauteur	Position Posición Position	Steel finish Acabado acero Finition acier
700022302	BSA 0867	2,5	-	73

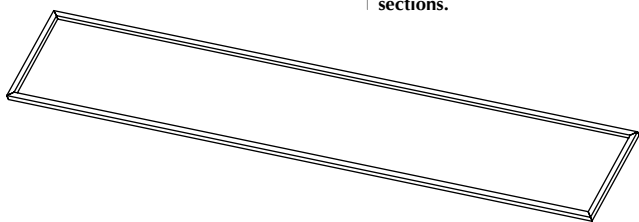
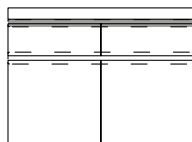

Under worktop framing for islands.
Frame section, 30 x 30 mm.
Can be done with or without with a flap on the front.
Aluminium profile.
Steel profile finish.
Price per linear metre.
Attach drawing with measures and flap sections.

Enmarcado bajo encimera para islas.
Sección del enmacado, 30 x 30 mm.
Puede ir con pestaña o sin pestaña.
Perfil de aluminio.
Acabado del perfil en acero.
Precio por metro lineal.
Adjuntar plano con las medidas y posición de las pestañas.

Encadrement sous plan de travail pour îlots.
Section de l'encadrement, 30 x 30 mm.
Peut être fait avec ou sans rabat.
Profilé en aluminium.
Finition du profil en acier.
Prix par metre lineaire.
Attachez le dessin avec les mesures et les position des rabats.

SAP	Code Código Code	Height Altura Hauteur	Position Posición Position	Steel finish Acabado acero Finition acier
700022303	BSA 0868	2,5	-	154

Base units
Módulos bajos
Modules Bas

Complements for models with integrated handle
Complementos para modelos con tirador integrado
Compléments pour modèles avec poignée intégrée

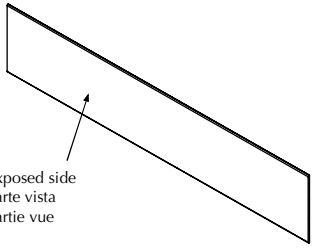

Exposed side
Parte vista
Partie vue

Horizontal spacer panel middle side profile for base units.
Steel profile finish.
Price per linear metre.

Perfil separador horizontal intermedio para módulos bajos.
Acabado del perfil en acero.
Precio por metro lineal.

Profile séparateur horizontal intermédiaire pour modules bas.
Finition du profil en acier.
Prix par metre lineaire.

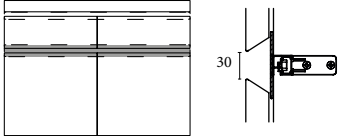

SAP	Code Código Code	Height Altura Hauteur	Position Posición Position	Steel finish Acabado acero Finition acier
700022304	BSA 0869	-	-	69

04 tower units columnas colonnes

Tower units / Columnas / Colonnes

p.90	H.150
p.104	H.198
p.122	H.210
p.140	H.222
p.152	H.234

Stackable units / Módulos apilables / Modules superposables

p.164	Stackable units Módulos apilables Modules superposables
-------	---

Complements / Complementos / Compléments

p.170	Complements for tower unit Complementos para módulo columna Compléments pour module colonne
-------	---

h. 150

Tower units
Columnas
Colonnes

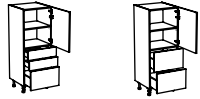
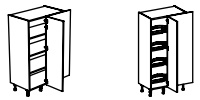
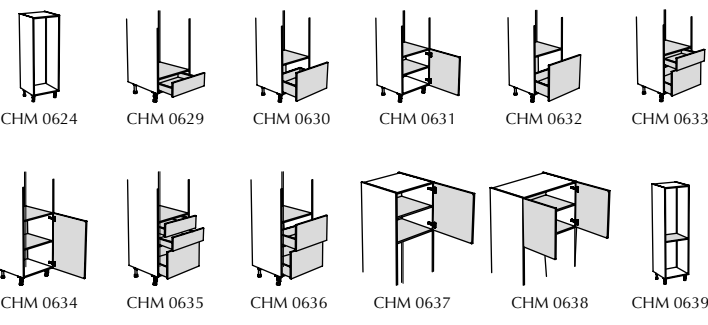
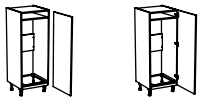
Type of unit Tipo de módulo Type de module	Available measures Medidas disponibles Dimensions disponibles	Available units Módulos disponibles Modules disponibles
<p>p.92 - 93 Tower unit with door Columna con puerta Colonne avec porte</p>	<p>Depth / Profundidad / Profondeur (cm.): 35 - 45 - 61</p> <p>Width / Ancho / Largeur (cm.): 30 - 40 - 45 - 50 - 60 (1 door) 76,2 - 80 - 90 - 100 - 120 (2 doors)</p>	 <p>CP 0500 - 0501 - 0502 CP 0503 - 0504 - 0505 CP 0506 - 0507 - 0508</p>
<p>p.94 Tower unit with door and drawer Columna con puerta y cajón Colonne avec porte et tiroir</p>	<p>Depth / Profundidad / Profondeur (cm.): 45 - 61</p> <p>Width / Ancho / Largeur (cm.): 30 - 40 - 45 - 50 - 60</p>	 <p>CCE 0509 - 0510 CE 0511 - 0512</p>
<p>p.95 - 96 Tower corner unit Módulo columna rinconero Module colonne encoignure</p>	<p>Depth / Profundidad / Profondeur (cm.): 61</p> <p>Door width / Ancho puerta / Largeur porte: 30 - 40 - 45 - 50 - 60</p>	 <p>CRR 0513 CRR 0514</p>
<p>p.98 - 101 Tower unit for oven and microwave Columna para horno y microondas Colonne pour four et micro-ondes</p>	<p>Depth / Profundidad / Profondeur (cm.): 61</p> <p>Width / Ancho / Largeur (cm.): 60 - 68,6 - 76,2 - 90 - 91,5</p>	 <p>CHM 0624 CHM 0629 CHM 0630 CHM 0631 CHM 0632 CHM 0633 CHM 0634 CHM 0635 CHM 0636 CHM 0637 CHM 0638 CHM 0639</p>
<p>p.102 Tower unit for fridge Módulo columna para frigorífico Module colonne pour réfrigérateur</p>	<p>Depth / Profundidad / Profondeur (cm.): 61</p> <p>Width / Ancho / Largeur (cm.): 60 - 68,6 - 76,2 - 90 - 91,5</p>	 <p>CFS 0641 CF 0642</p>

Tower units
Columnas
Colonnes

Tower unit with door
Módulo columna con puerta
Module colonne avec porte

H. 150

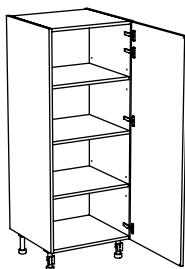

Tower unit with door.
1 door.
1 fixed shelf.
2 shelves.

Módulo columna con puerta.
1 puerta.
1 balda fija.
2 baldas.

Module colonne avec porte.
1 porte.
1 étagère fixe.
2 étagères.

Availability / disponibilidad / disponibilité:

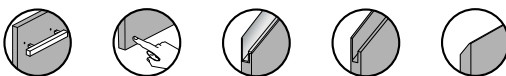

61 depth / profundidad / profondeur

SAP	Code Código Code	Width Ancho Largeur	Opening Apertura Ouverture											
				0	1	2	3	4	5	6	7	8	9	10
700021312	CP 0500	30	L / R	521	556	-	625	658	686	-	726	-	-	-
700021313	CP 0500	40	L / R	528	571	-	647	675	708	-	762	-	-	-
700021314	CP 0500	45	L / R	538	587	-	667	698	737	-	797	-	-	-
700021315	CP 0500	50	L / R	547	599	-	683	705	739	-	805	-	-	-
700021316	CP 0500	60	L / R	578	636	-	729	768	800	-	865	-	-	-

45 depth / profundidad / profondeur

SAP	Code Código Code	Width Ancho Largeur	Opening Apertura Ouverture											
				0	1	2	3	4	5	6	7	8	9	10
700021317	CP 0501	30	L / R	477	515	-	579	611	639	-	680	-	-	-
700021318	CP 0501	40	L / R	491	535	-	607	635	662	-	709	-	-	-
700021319	CP 0501	45	L / R	499	550	-	627	656	689	-	742	-	-	-
700021320	CP 0501	50	L / R	506	560	-	641	668	710	-	763	-	-	-
700021321	CP 0501	60	L / R	520	581	-	669	693	732	-	804	-	-	-

35 depth / profundidad / profondeur

SAP	Code Código Code	Width Ancho Largeur	Opening Apertura Ouverture											
				0	1	2	3	4	5	6	7	8	9	10
700021322	CP 0502	30	L / R	446	485	-	546	578	606	-	646	-	-	-
700021323	CP 0502	40	L / R	463	509	-	579	606	639	-	693	-	-	-
700021324	CP 0502	45	L / R	471	523	-	597	626	659	-	713	-	-	-
700021325	CP 0502	50	L / R	477	532	-	610	637	667	-	732	-	-	-
700021326	CP 0502	60	L / R	489	551	-	636	659	699	-	772	-	-	-

H. 150

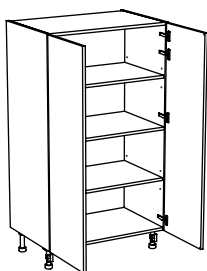

Tower unit with door.
2 doors.
1 fixed shelf.
2 shelves.

Módulo columna con puerta.
2 puertas.
1 balda fija.
2 baldas.

Module colonne avec porte.
2 portes.
1 étagère fixe.
2 étagères.

Availability / disponibilidad / disponibilité:

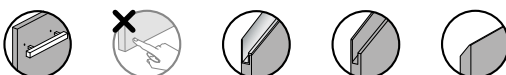

61 depth / profundidad / profondeur

SAP	Code Código Code	Width Ancho Largeur	Opening Apertura Ouverture											
				0	1	2	3	4	5	6	7	8	9	10
700021327	CP 0503	76,2	-	628	728	-	839	894	945	-	1037	-	-	-
700021328	CP 0503	80	-	634	737	-	851	900	957	-	1054	-	-	-
700021329	CP 0503	90	-	650	766	-	889	941	1011	-	1120	-	-	-
700021330	CP 0503	100	-	667	789	-	920	968	1042	-	1164	-	-	-
700021331	CP 0503	120	-	719	854	-	1003	1044	1126	-	1274	-	-	-

45 depth / profundidad / profondeur

SAP	Code Código Code	Width Ancho Largeur	Opening Apertura Ouverture											
				0	1	2	3	4	5	6	7	8	9	10
700021332	CP 0504	76,2	-	575	678	-	785	838	890	-	982	-	-	-
700021333	CP 0504	80	-	586	691	-	801	849	906	-	1003	-	-	-
700021334	CP 0504	90	-	599	717	-	836	887	957	-	1067	-	-	-
700021335	CP 0504	100	-	613	738	-	864	912	986	-	1108	-	-	-
700021336	CP 0504	120	-	648	785	-	928	986	1051	-	1198	-	-	-

35 depth / profundidad / profondeur

SAP	Code Código Code	Width Ancho Largeur	Opening Apertura Ouverture											
				0	1	2	3	4	5	6	7	8	9	10
700021337	CP 0505	76,2	-	531	635	-	738	791	843	-	936	-	-	-
700021338	CP 0505	80	-	535	643	-	748	795	853	-	951	-	-	-
700021339	CP 0505	90	-	554	674	-	788	838	909	-	1019	-	-	-
700021340	CP 0505	100	-	569	696	-	818	865	940	-	1062	-	-	-
700021341	CP 0505	120	-	605	744	-	883	940	1005	-	1154	-	-	-

Tower units
Columnas
Colonnes

Tower unit with door
Módulo columna con puerta
Module colonne avec porte

H. 150

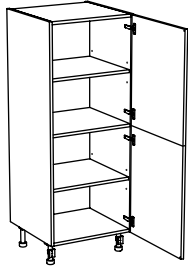

Tower unit with door.
2 doors.
1 fixed shelf.
2 shelves.

Módulo columna con puerta.
2 puertas.
1 balda fija.
2 baldas.

Module colonne avec porte.
2 portes.
1 étagère fixe.
2 étagères.

Availability / disponibilidad / disponibilité:

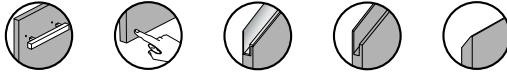

61 depth / profundidad / profondeur

SAP	Code Código Code	Width Ancho Largeur	Opening Apertura Ouverture	0	1	2	3	4	5	6	7	8	9	10
				700021342	CP 0506	30	L / R	536	596	-	674	722	754	-
700021343	CP 0506	40	L / R	544	614	-	694	745	792	-	853	-	-	-
700021344	CP 0506	45	L / R	554	631	-	721	768	817	-	885	-	-	-
700021345	CP 0506	50	L / R	562	642	-	730	782	826	-	908	-	-	-
700021346	CP 0506	60	L / R	593	680	-	777	827	873	-	969	-	-	-

45 depth / profundidad / profondeur

SAP	Code Código Code	Width Ancho Largeur	Opening Apertura Ouverture	0	1	2	3	4	5	6	7	8	9	10
				700021347	CP 0507	30	L / R	492	554	-	628	677	722	-
700021348	CP 0507	40	L / R	506	578	-	660	706	745	-	812	-	-	-
700021349	CP 0507	45	L / R	515	593	-	680	727	769	-	843	-	-	-
700021350	CP 0507	50	L / R	522	604	-	688	740	783	-	865	-	-	-
700021351	CP 0507	60	L / R	535	624	-	717	766	812	-	899	-	-	-

35 depth / profundidad / profondeur

SAP	Code Código Code	Width Ancho Largeur	Opening Apertura Ouverture	0	1	2	3	4	5	6	7	8	9	10
				700021352	CP 0508	30	L / R	461	524	-	595	644	676	-
700021353	CP 0508	40	L / R	479	552	-	632	677	716	-	783	-	-	-
700021354	CP 0508	45	L / R	486	566	-	650	697	739	-	813	-	-	-
700021355	CP 0508	50	L / R	492	576	-	664	710	753	-	834	-	-	-
700021356	CP 0508	60	L / R	504	595	-	684	734	780	-	866	-	-	-

H. 150

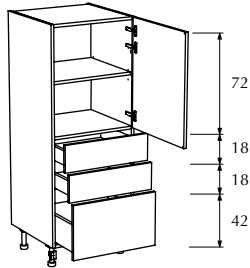

Tower unit with door.
1 door.
2 drawers.
1 deep drawer.
1 fixed shelf.
1 shelf.

Módulo columna con puerta.
1 puerta.
2 cajones.
1 gaveta.
1 balda fija.
1 balda.

Module colonne avec porte.
1 porte.
2 tiroirs.
1 extractible.
1 étagère fixe.
1 étagère.

Availability / disponibilidad / disponibilité:

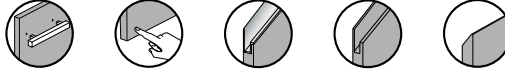

61 depth / profundidad / profondeur

SAP	Code Código Code	Width Ancho Largeur	Opening Apertura Ouverture											
				0	1	2	3	4	5	6	7	8	9	10
700021357	CCE 0509	30	L / R	1004	1098	-	1227	1338	1392	-	1472	-	-	-
700021358	CCE 0509	40	L / R	1019	1122	-	1259	1369	1424	-	1519	-	-	-
700021359	CCE 0509	45	L / R	1033	1142	-	1284	1396	1454	-	1557	-	-	-
700021360	CCE 0509	50	L / R	1045	1158	-	1305	1417	1475	-	1585	-	-	-
700021361	CCE 0509	60	L / R	1081	1203	-	1361	1476	1539	-	1649	-	-	-

45 depth / profundidad / profondeur

SAP	Code Código Code	Width Ancho Largeur	Opening Apertura Ouverture											
				0	1	2	3	4	5	6	7	8	9	10
700021362	CCE 0510	30	L / R	981	1076	-	1203	1314	1368	-	1447	-	-	-
700021363	CCE 0510	40	L / R	1004	1107	-	1243	1353	1408	-	1503	-	-	-
700021364	CCE 0510	45	L / R	1017	1126	-	1267	1379	1437	-	1539	-	-	-
700021365	CCE 0510	50	L / R	1027	1141	-	1286	1398	1456	-	1565	-	-	-
700021366	CCE 0510	60	L / R	1048	1171	-	1325	1441	1503	-	1628	-	-	-

H. 150

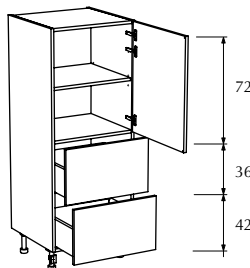

Tower unit with door.
1 door.
2 deep drawers.
1 fixed shelf.
1 shelf.

Módulo columna con puerta.
1 puerta.
2 gavetas.
1 balda fija.
1 balda.

Module colonne avec porte.
1 porte.
2 extractibles.
1 étagère fixe.
1 étagère.

Availability / disponibilidad / disponibilité:

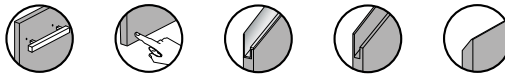

61 depth / profundidad / profondeur

SAP	Code Código Code	Width Ancho Largeur	Opening Apertura Ouverture											
				0	1	2	3	4	5	6	7	8	9	10
700021367	CE 0511	30	L / R	896	970	-	1096	1191	1246	-	1334	-	-	-
700021368	CE 0511	40	L / R	908	989	-	1113	1218	1273	-	1375	-	-	-
700021369	CE 0511	45	L / R	920	1007	-	1136	1243	1312	-	1411	-	-	-
700021370	CE 0511	50	L / R	930	1021	-	1154	1262	1330	-	1436	-	-	-
700021371	CE 0511	60	L / R	962	1060	-	1203	1311	1380	-	1487	-	-	-

45 depth / profundidad / profondeur

SAP	Code Código Code	Width Ancho Largeur	Opening Apertura Ouverture											
				0	1	2	3	4	5	6	7	8	9	10
700021372	CE 0512	30	L / R	870	944	-	1057	1163	1218	-	1305	-	-	-
700021373	CE 0512	40	L / R	889	970	-	1092	1198	1252	-	1354	-	-	-
700021374	CE 0512	45	L / R	899	988	-	1114	1221	1279	-	1388	-	-	-
700021375	CE 0512	50	L / R	908	1000	-	1130	1238	1295	-	1399	-	-	-
700021376	CE 0512	60	L / R	925	1024	-	1163	1272	1328	-	1433	-	-	-

Tower units
Columnas
Colonnes

Tower corner unit
Módulo columna rinconero
Module colonne encoignure

H. 150

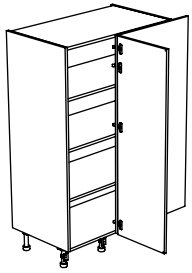

Tower straight corner unit.
1 door.
1 fixed shelf.
2 shelves.
Unit for standard corner filler, 10x10 cm.
Order corner filler separately to insert between add-on units for 90° union.

Módulo columna rinconero recto.
1 puerta.
1 balda fija.
2 baldas.
Módulo para regletas de unión estándar, 10x10 cm.
Solicitar regleta de unión por separado.

Modules colonne encoignure droite.
1 porte.
1 étagère fixe.
2 étagères.
Module pour fileur d'encoignure standard, 10x10 cm.
Commander fileur d'union séparément.

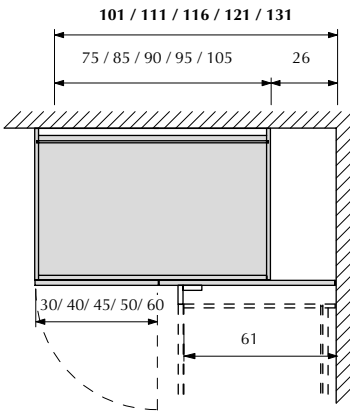

Availability / disponibilidad / disponibilité:

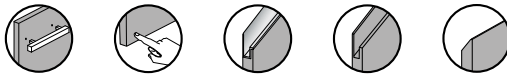

61 depth / profundidad / profondeur

SAP	Code Código Code	Width Ancho Largeur	Opening Apertura Ouverture	0	1	2	3	4	5	6	7	8	9	10
700021377	CRR 0513	101	L / R	631	756	-	892	929	968	-	1066	-	-	-
700021378	CRR 0513	111	L / R	647	779	-	924	965	1010	-	1110	-	-	-
700021379	CRR 0513	116	L / R	655	793	-	943	989	1038	-	1143	-	-	-
700021380	CRR 0513	121	L / R	664	805	-	958	1005	1044	-	1165	-	-	-
700021381	CRR 0513	131	L / R	679	827	-	989	1024	1071	-	1208	-	-	-

H. 150

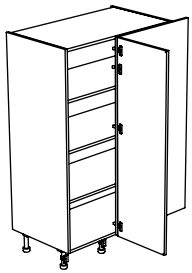

Tower straight corner unit.
1 door.
1 fixed shelf.
2 shelves.
Unit for corner filler with raised door profile 4x4 cm.
Order corner filler separately to insert between add-on units for 90° union.

Módulo columna rinconero recto.
1 puerta.
1 balda fija.
2 baldas.
Módulo para regleta de rincón con perfil de puerta de 4x4 cm.
Solicitar regleta de unión por separado.

Modules colonne encoignure droite.
1 porte.
1 étagère fixe.
2 étagères.
Module pour fileur d'encoignure avec profilé de porte, 4x4 cm.
Commander fileur d'union séparément.

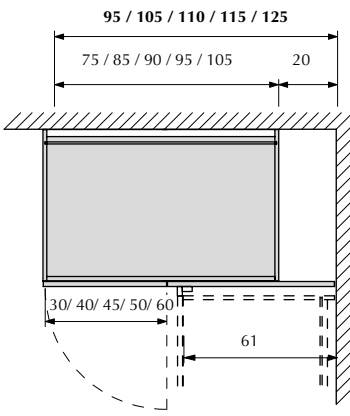

Availability / disponibilidad / disponibilité:

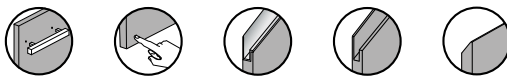

61 depth / profundidad / profondeur

SAP	Code Código Code	Width Ancho Largeur	Opening Apertura Ouverture	0	1	2	3	4	5	6	7	8	9	10
700022009	CRR 0513	95	L / R	631	756	-	884	920	968	-	1066	-	-	-
700022010	CRR 0513	105	L / R	647	779	-	924	965	1010	-	1110	-	-	-
700022011	CRR 0513	110	L / R	655	793	-	943	989	1038	-	1143	-	-	-
700022012	CRR 0513	115	L / R	664	805	-	958	1005	1054	-	1165	-	-	-
700022013	CRR 0513	125	L / R	679	827	-	980	1024	1061	-	1208	-	-	-

H. 150

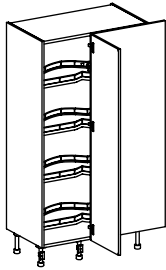

Tower straight corner unit.
1 door.
4 Rotating drawers shelves.
Unit for standard corner filler, 10x10 cm.
Order corner filler separately to insert between add-on units for 90° union.

Módulo columna rinconero recto.
1 puerta.
4 Baldas giratorias y extraíbles.
Módulo para regleta de unión estándar, 10x10 cm.
Solicitar regleta de unión por separado.

Modules colonne encoignure droite.
1 porte.
4 Étagères pivotantes extractibles.
Module pour fileur d'encoignure standard, 10x10 cm.
Commander fileur d'union séparément.

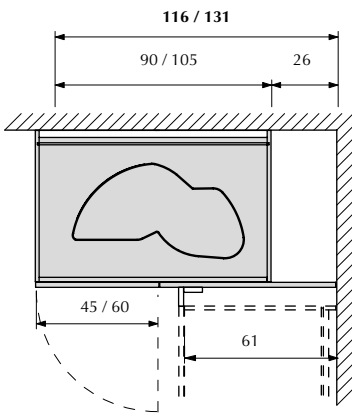

Availability / disponibilidad / disponibilité:

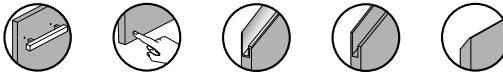

61 depth / profundidad / profondeur

SAP	Code Código Code	Width Ancho Largeur	Opening Apertura Ouverture											
				0	1	2	3	4	5	6	7	8	9	10
700021382	CRR 0514	116	L / R	2342	2451	-	2698	2776	2831	-	2960	-	-	-
700021384	CRR 0514	131	L / R	2554	2669	-	2940	3023	3081	-	3227	-	-	-

H. 150

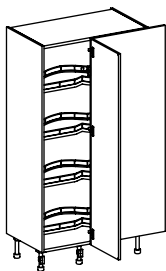

Tower straight corner unit.
1 door.
4 Rotating drawers shelves.
Unit for corner filler with raised door profile 4x4 cm.
Order corner filler separately to insert between add-on units for 90° union.

Módulo columna rinconero recto.
1 puerta.
4 Baldas giratorias y extraíbles.
Módulo para regleta de rincón con perfil de puerta de 4x4 cm.
Solicitar regleta de unión por separado.

Modules colonne encoignure droite.
1 porte.
4 Étagères pivotantes extractibles.
Module pour fileur d'encoignure avec profilé de porte, 4x4 cm.
Commander fileur d'union séparément.

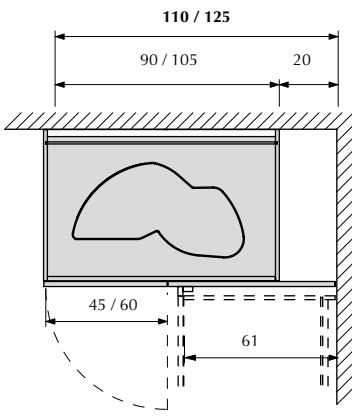

Availability / disponibilidad / disponibilité:

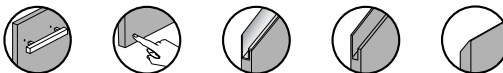

61 depth / profundidad / profondeur

SAP	Code Código Code	Width Ancho Largeur	Opening Apertura Ouverture											
				0	1	2	3	4	5	6	7	8	9	10
700022014	CRR 0514	110	L / R	2342	2451	-	2698	2776	2858	-	3016	-	-	-
700022016	CRR 0514	125	L / R	2554	2669	-	2940	3023	3081	-	3227	-	-	-

H. 150

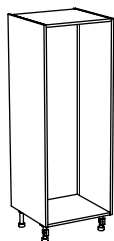

Carcass for tower unit kit for oven and microwave.

Comments:

Must be filled with units for oven and microwave tower unit kit.
See instructions on chapter 01.

Casco para kit columna de horno y microondas.

Observaciones:

Se debe completar con módulos para kit columna horno y microondas.
Ver instrucciones en capítulos 01.

Caisson pour kit colonne pour four et micro-ondes.

Remarques:

Doit être complétés avec les modules pour kit colonne four et micro-ondes.
Voir instructions en chapitre 01.

Availability / disponibilidad / disponibilité:



61 depth / profundidad / profondeur

SAP	Code Código Code	Width Ancho Largeur	Opening Apertura Ouverture	Carcass colour Color de casco Couleur de caisson
700021890	CHM 0624	60	-	376
700021891	CHM 0624	68,6	-	381
700021892	CHM 0624	76,2	-	385
700021893	CHM 0624	90	-	392
700021894	CHM 0624	91,5	-	393

H. 150

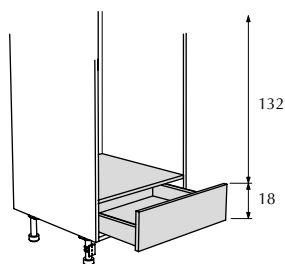

Lower unit with drawers for kit for oven and microwave.

1 drawer.
1 top shelf.
1 back panel.

H 18

Módulo inferior con cajones para kit columna de horno y microondas.

1 cajón.
1 techo.
1 trasera.

H 18

Module inférieur avec tiroirs pour four et micro-ondes.

1 tiroir.
1 joue superieure.
1 panneau arrière.

H 18

Availability / disponibilidad / disponibilité:

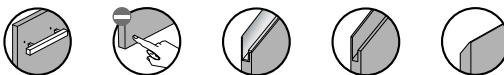

61 depth / profundidad / profondeur

SAP	Code Código Code	Width Ancho Largeur	Opening Apertura Ouverture											
				0	1	2	3	4	5	6	7	8	9	10
700021915	CHM 0629	60	-	285	308	-	353	376	387	-	407	-	-	-
700021916	CHM 0629	68,6	-	295	318	-	365	391	402	-	421	-	-	-
700021917	CHM 0629	76,2	-	303	327	-	376	403	413	-	433	-	-	-
700021918	CHM 0629	90	-	312	338	-	389	415	426	-	448	-	-	-
700021919	CHM 0629	91,5	-	313	339	-	390	418	431	-	450	-	-	-

H. 150

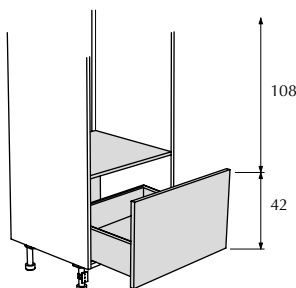

Lower unit with drawers for kit for oven and microwave.

1 deep drawer.
1 top shelf.
1 back panel.

H 42

Módulo inferior con cajones para kit columna de horno y microondas.

1 gaveta.
1 techo.
1 trasera.

H 42

Module inférieur avec tiroirs pour four et micro-ondes.

1 extractible.
1 joue superieure.
1 panneau arrière.

H 42

Availability / disponibilidad / disponibilité:

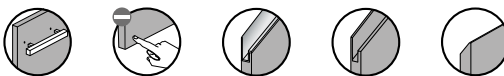

61 depth / profundidad / profondeur

SAP	Code Código Code	Width Ancho Largeur	Opening Apertura Ouverture											
				0	1	2	3	4	5	6	7	8	9	10
700021920	CHM 0630	60	-	332	361	-	407	435	455	-	486	-	-	-
700021921	CHM 0630	68,6	-	342	372	-	421	450	469	-	504	-	-	-
700021922	CHM 0630	76,2	-	353	388	-	440	470	492	-	530	-	-	-
700021923	CHM 0630	90	-	363	400	-	455	484	504	-	542	-	-	-
700021924	CHM 0630	91,5	-	364	401	-	457	488	508	-	544	-	-	-

H. 150

Lower unit with door for kit for oven and microwave.
1 door.
1 shelf.
1 top shelf.
1 back panel.
H 60

Módulo inferior con puerta para kit columna de horno y microondas.
1 puerta.
1 balda.
1 techo.
1 trasera.
H 60

Module inférieur avec porte pour four et micro-ondes.
1 porte.
1 étagère.
1 joue supérieure.
1 panneau arrière.
H 60

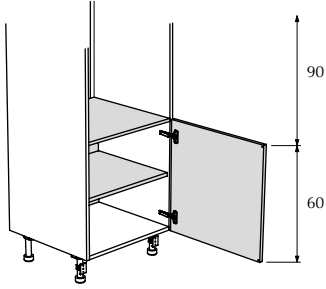

Availability / disponibilidad / disponibilité:

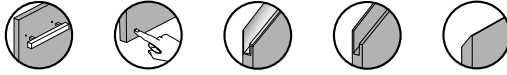

61 depth / profundidad / profondeur

SAP	Code Código Code	Width Ancho Largeur	Opening Apertura Ouverture											
				0	1	2	3	4	5	6	7	8	9	10
700021925	CHM 0631	60	-	172	216	-	257	278	297	-	329	-	-	-
700021926	CHM 0631	68,6	-	178	224	-	268	291	314	-	351	-	-	-
700021927	CHM 0631	76,2	-	183	231	-	273	301	324	-	358	-	-	-

H. 150

Lower unit with drawers for kit for oven and microwave.
1 deep drawer.
1 top shelf.
1 back panel.
H 60

Módulo inferior con cajones para kit columna de horno y microondas.
1 gaveta.
1 techo.
1 trasera.
H 60

Module inférieur avec tiroirs pour four et micro-ondes.
1 extractible.
1 jeu supérieur.
1 panneau arrière.
H 60

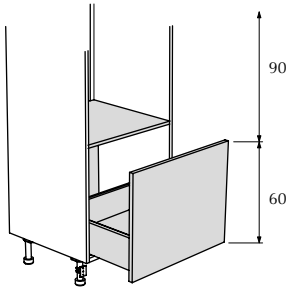

Availability / disponibilidad / disponibilité:

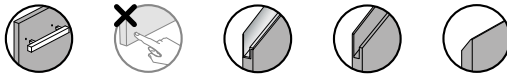

61 depth / profundidad / profondeur

SAP	Code Código Code	Width Ancho Largeur	Opening Apertura Ouverture											
				0	1	2	3	4	5	6	7	8	9	10
700021928	CHM 0632	60	-	338	375	-	423	452	475	-	511	-	-	-
700021929	CHM 0632	68,6	-	348	388	-	439	469	491	-	527	-	-	-
700021930	CHM 0632	76,2	-	357	398	-	453	483	505	-	545	-	-	-
700021931	CHM 0632	90	-	367	412	-	471	507	529	-	566	-	-	-
700021932	CHM 0632	91,5	-	368	414	-	473	509	531	-	569	-	-	-

H. 150

Lower unit with drawers for kit for oven and microwave.
1 drawer.
1 deep drawer.
1 top shelf.
1 back panel.
H 60

Módulo inferior con cajones para kit columna de horno y microondas.
1 cajón.
1 gaveta.
1 techo.
1 trasera.
H 60

Module inférieur avec tiroirs pour four et micro-ondes.
1 tiroir.
1 extractible.
1 joue supérieure.
1 panneau arrière.
H 60

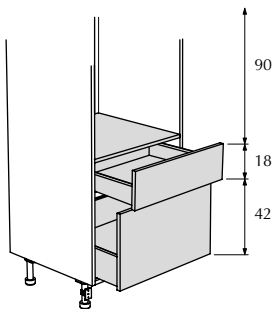

Availability / disponibilidad / disponibilité:



61 depth / profundidad / profondeur

SAP	Code Código Code	Width Ancho Largeur	Opening Apertura Ouverture											
				0	1	2	3	4	5	6	7	8	9	10
700021933	CHM 0633	60	-	504	560	-	637	692	725	-	771	-	-	-
700021934	CHM 0633	68,6	-	521	579	-	660	721	748	-	792	-	-	-
700021935	CHM 0633	76,2	-	536	599	-	691	746	776	-	817	-	-	-
700021936	CHM 0633	90	-	551	618	-	702	768	801	-	850	-	-	-
700021937	CHM 0633	91,5	-	552	620	-	705	770	804	-	853	-	-	-

H. 150

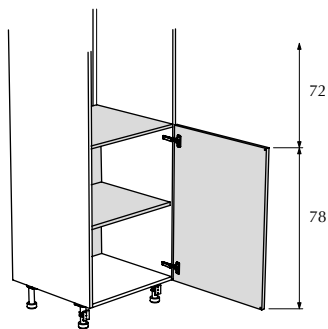

Lower unit with door for kit for oven and microwave.
1 door.
1 shelf.
1 top shelf.
1 back panel.
H 78

Módulo inferior con puerta para kit columna de horno y microondas.
1 puerta.
1 balda.
1 techo.
1 trasera.
H 78

Module inférieur avec porte pour four et micro-ondes.
1 porte.
1 étagère.
1 joue supérieure.
1 panneau arrière.
H 78

Availability / disponibilidad / disponibilité:

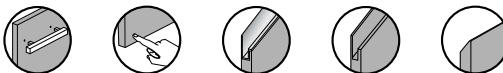

61 depth / profundidad / profondeur

SAP	Code Código Code	Width Ancho Largeur	Opening Apertura Ouverture											
				0	1	2	3	4	5	6	7	8	9	10
700021938	CHM 0634	60	-	175	225	-	263	288	311	-	352	-	-	-
700021939	CHM 0634	68,6	-	181	234	-	276	301	327	-	371	-	-	-
700021940	CHM 0634	76,2	-	187	242	-	287	312	339	-	388	-	-	-

H. 150

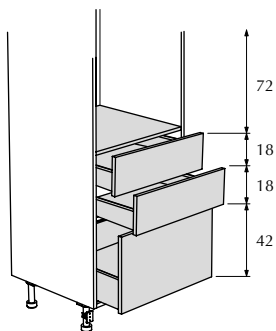

Lower unit with drawers for kit for oven and microwave.
2 drawers.
1 deep drawer.
1 top shelf.
1 back panel.
H 78

Módulo inferior con cajones para kit columna de horno y microondas.
2 cajones.
1 gaveta.
1 techo.
1 trasera.
H 78

Module inférieur avec tiroirs pour four et micro-ondes.
2 tiroirs.
1 extractible.
1 joue supérieure.
1 panneau arrière.
H 78

Availability / disponibilidad / disponibilité:

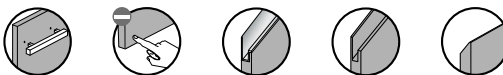

61 depth / profundidad / profondeur

SAP	Code Código Code	Width Ancho Largeur	Opening Apertura Ouverture											
				0	1	2	3	4	5	6	7	8	9	10
700021941	CHM 0635	60	-	674	758	-	853	931	974	-	1043	-	-	-
700021942	CHM 0635	68,6	-	697	784	-	884	971	1024	-	1092	-	-	-
700021943	CHM 0635	76,2	-	718	811	-	916	1005	1051	-	1124	-	-	-
700021944	CHM 0635	90	-	740	839	-	951	1036	1077	-	1159	-	-	-
700021945	CHM 0635	91,5	-	743	841	-	955	1046	1100	-	1186	-	-	-

H. 150

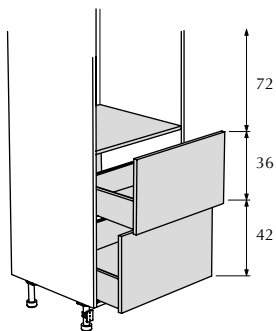

Lower unit with drawers for kit for oven and microwave.
2 deep drawers.
1 top shelf.
1 back panel.
H 78

Módulo inferior con cajones para kit columna de horno y microondas.
2 gavetas.
1 techo.
1 trasera.
H 78

Module inférieur avec tiroirs pour four et micro-ondes.
2 extractibles.
1 joue supérieure.
1 panneau arrière.
H 78

Availability / disponibilidad / disponibilité:

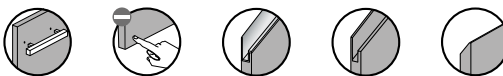

61 depth / profundidad / profondeur

SAP	Code Código Code	Width Ancho Largeur	Opening Apertura Ouverture											
				0	1	2	3	4	5	6	7	8	9	10
700021946	CHM 0636	60	-	550	610	-	690	764	826	-	901	-	-	-
700021947	CHM 0636	68,6	-	567	630	-	735	800	852	-	934	-	-	-
700021948	CHM 0636	76,2	-	582	651	-	761	824	874	-	952	-	-	-
700021949	CHM 0636	90	-	599	676	-	794	855	906	-	1004	-	-	-
700021950	CHM 0636	91,5	-	601	678	-	797	864	917	-	1008	-	-	-

H. 150

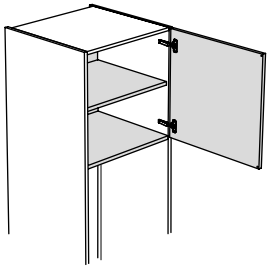

Upper unit with door for kit for oven and microwave.
1 door.
1 Shelf.
1 base shelf.
1 back panel.
Variable height.
Minimum height, 30 cm.

Módulo superior con puerta para kit columna de horno y microondas.
1 puerta.
1 balda.
1 base.
1 trasera.
Altura variable.
Altura mínima, 30 cm.

Modules supérieur avec porte pour four et micro-ondes.
1 porte.
1 étagère.
1 joue inférieure.
1 panneau arrière.
Hauteur variable.
Hauteur minimale de 30 cm.

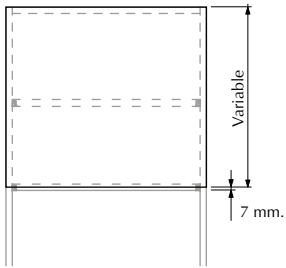

Availability / disponibilidad / disponibilité:

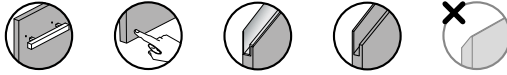

61 depth / profundidad / profondeur

SAP	Code Código Code	Width Ancho Largeur	Opening Apertura Ouverture											
				0	1	2	3	4	5	6	7	8	9	10
700021951	CHM 0637	60	-	177	230	-	273	300	327	-	368	-	-	-
700021952	CHM 0637	68,6	-	184	244	-	290	320	352	-	400	-	-	-
700021953	CHM 0637	76,2	-	191	254	-	304	335	367	-	420	-	-	-

H. 150

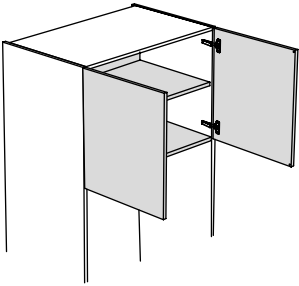

Upper unit with door for kit for oven and microwave.
2 doors.
1 Shelf.
1 base shelf.
1 back panel.
Variable height.
Minimum height, 30 cm.

Módulo superior con puerta para kit columna de horno y microondas.
2 puertas.
1 balda.
1 base.
1 trasera.
Altura variable.
Altura mínima, 30 cm.

Modules supérieur avec porte pour four et micro-ondes.
2 portes.
1 étagère.
1 joue inférieure.
1 panneau arrière.
Hauteur variable.
Hauteur minimale de 30 cm.

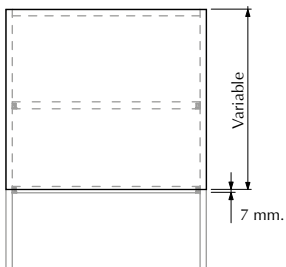

Availability / disponibilidad / disponibilité:

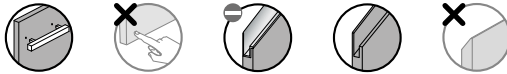

61 depth / profundidad / profondeur

SAP	Code Código Code	Width Ancho Largeur	Opening Apertura Ouverture											
				0	1	2	3	4	5	6	7	8	9	10
700021954	CHM 0638	76,2	-	207	299	-	367	409	457	-	518	-	-	-
700021955	CHM 0638	90	-	217	315	-	379	425	476	-	542	-	-	-
700021956	CHM 0638	91,5	-	218	325	-	397	450	498	-	576	-	-	-

H. 150

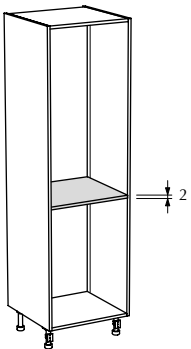

Shelf for kit for oven and microwave.
1 shelf.
H 2

Balda para kit columna de horno y microondas.
1 balda.
H 2

Étagère pour four et micro-ondes.
1 étagère.
H 2

61 depth / profundidad / profondeur

SAP	Code Código Code	Width Ancho Largeur	Opening Apertura Ouverture	Carcass colour
				Color de casco Couleur de caisson
700021957	CHM 0639	60	-	66
700021958	CHM 0639	68,6	-	69
700021959	CHM 0639	76,2	-	71
700021960	CHM 0639	90	-	74
700021961	CHM 0639	91,5	-	74

Tower units
Columnas
Colonnes

Tower unit for fridge
Módulo columna para frigorífico
Module colonne pour réfrigérateur

H. 150

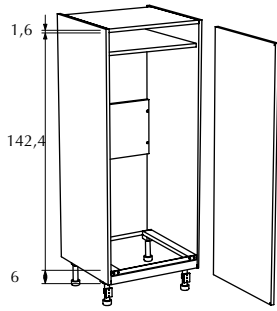

Tower unit for fridge.
1 structure with ventilation grille.
1 shelf.
1 back panel.
WITHOUT hinges.

Columna de frigorífico.
1 estructura con rejilla de ventilación.
1 balda.
1 trasera.
SIN bisagras.

Colonne réfrigérateur.
1 structure avec grille d'aération.
1 étagère.
1 panneau arrière.
SANS charnières.

Availability / disponibilidad / disponibilité:

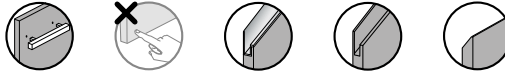

61 depth / profundidad / profondeur

SAP	Code Código Code	Width Ancho Largeur	Opening Apertura Ouverture	0	1	2	3	4	5	6	7	8	9	10
				700021962	CFS 0641	60	-	549	619	-	699	724	770	-

H. 150

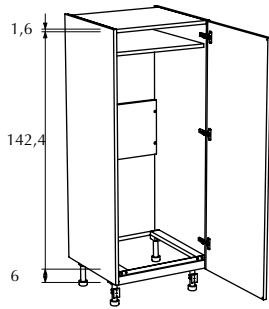

Tower unit for fridge.
1 structure with ventilation grille.
1 shelf.
1 back panel.
WITH hinges.

Columna de frigorífico.
1 estructura con rejilla de ventilación.
1 balda.
1 trasera.
CON bisagras.

Colonne réfrigérateur.
1 structure avec grille d'aération.
1 étagère.
1 panneau arrière.
AVEC charnières.

Availability / disponibilidad / disponibilité:

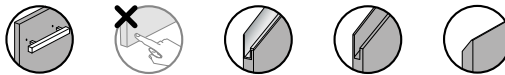































61 depth / profundidad / profondeur

SAP	Code Código Code	Width Ancho Largeur	Opening Apertura Ouverture	0	1	2	3	4	5	6	7	8	9	10
				700021963	CF 0642	60	L / R	549	619	-	699	724	770	-

h. 198

Tower units
Columnas
Colonnes

Type of unit Tipo de módulo Type de module	Available measures Medidas disponibles Dimensions disponibles	Available units Módulos disponibles Modules disponibles
p.106 - 107 Tower unit with door Columna con puerta Colonne avec porte	Depth / Profundidad / Profondeur (cm.): 35 - 45 - 61 Width / Ancho / Largeur (cm.): 30 - 40 - 45 - 50 - 60 (1 door) 76,2 - 80 - 90 - 100 - 120 (2 doors)	 CP 0516 - 0517 - 0518  CP 0519 - 0520 - 0521  CP 0522 - 0523 - 0524  CP 0525 - 0526 - 0527
p.108 Tower unit with door and drawer Columna con puerta y cajón Colonne avec porte et tiroir	Depth / Profundidad / Profondeur (cm.): 45 - 61 Width / Ancho / Largeur (cm.): 30 - 40 - 45 - 50 - 60	 CCE 0528 - 0529  CE 0530 - 0531
p.109 - 111 Tower corner unit Módulo columna rinconero Module colonne encoignure	Depth / Profundidad / Profondeur (cm.): 61 Door width / Ancho puerta / Largeur porte: 30 - 40 - 45 - 50 - 60	 CRR 0532  CRR 0533  CRR 0534
p.112 Tower broom and cleaning product unit Columna para útiles de limpieza Colonne pour utensiles de nettoyage	Depth / Profundidad / Profondeur (cm.): 35 - 45 - 61 Width / Ancho / Largeur (cm.): 30 - 40 - 45 - 50 - 60	 CUL 0535 - 0536 - 0537  CUL 0538 - 0539 - 0540
p.113 Tower unit with interior equipment Columna con equipamiento interior Colonne avec équipement intérieur	Depth / Profundidad / Profondeur (cm.): 61 Width / Ancho / Largeur (cm.): 30	 CEQ 0541  CEQ 0542
p.114 - 117 Tower unit for oven and microwave Columna para horno y microondas Colonne pour four et micro-ondes	Depth / Profundidad / Profondeur (cm.): 61 Width / Ancho / Largeur (cm.): 60 - 68,6 - 76,2 - 90 - 91,5	 CHM 0625  CHM 0629  CHM 0630  CHM 0631  CHM 0632  CHM 0633  CHM 0634  CHM 0635  CHM 0636  CHM 0637  CHM 0638  CHM 0639
p.118 - 120 Tower unit for fridge Módulo columna para frigorífico Module colonne pour réfrigérateur	Depth / Profundidad / Profondeur (cm.): 61 Width / Ancho / Largeur (cm.): 60 - 68,6 - 76,2 - 90 - 91,5	 CFS 0643  CF 0644  CFS 0645  CF 0646  CFS 0647  CF 0648

Tower units
Columnas
Colonnes

Tower unit with door
Módulo columna con puerta
Module colonne avec porte

H. 198

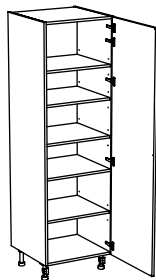

Tower unit with door.
1 door.
1 fixed shelf.
4 shelves.

Módulo columna con puerta.
1 puerta.
1 balda fija.
4 baldas.

Module colonne avec porte.
1 porte.
1 étagère fixe.
4 étagères.

Availability / disponibilidad / disponibilité:



61 depth / profundidad / profondeur

SAP	Code Código Code	Width Ancho Largeur	Opening Apertura Ouverture											
				0	1	2	3	4	5	6	7	8	9	10
700021386	CP 0516	30	L / R	609	660	-	732	758	781	-	-	-	-	-
700021387	CP 0516	40	L / R	625	688	-	770	796	827	-	-	-	-	-
700021388	CP 0516	45	L / R	636	704	-	790	812	847	-	-	-	-	-
700021389	CP 0516	50	L / R	650	726	-	818	844	883	-	-	-	-	-
700021390	CP 0516	60	L / R	692	777	-	880	899	946	-	-	-	-	-

45 depth / profundidad / profondeur

SAP	Code Código Code	Width Ancho Largeur	Opening Apertura Ouverture											
				0	1	2	3	4	5	6	7	8	9	10
700021391	CP 0517	30	L / R	556	608	-	676	702	725	-	-	-	-	-
700021392	CP 0517	40	L / R	576	641	-	719	745	776	-	-	-	-	-
700021393	CP 0517	45	L / R	585	655	-	737	760	795	-	-	-	-	-
700021394	CP 0517	50	L / R	597	675	-	763	790	829	-	-	-	-	-
700021395	CP 0517	60	L / R	616	703	-	801	835	867	-	-	-	-	-

35 depth / profundidad / profondeur

SAP	Code Código Code	Width Ancho Largeur	Opening Apertura Ouverture											
				0	1	2	3	4	5	6	7	8	9	10
700021396	CP 0518	30	L / R	522	576	-	641	667	691	-	-	-	-	-
700021397	CP 0518	40	L / R	548	614	-	689	715	747	-	-	-	-	-
700021398	CP 0518	45	L / R	556	626	-	707	736	764	-	-	-	-	-
700021399	CP 0518	50	L / R	567	645	-	731	758	797	-	-	-	-	-
700021400	CP 0518	60	L / R	583	670	-	766	799	832	-	-	-	-	-

H. 198

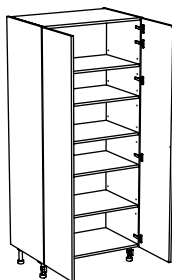

Tower unit with door.
2 doors.
1 fixed shelf.
4 shelves.

Módulo columna con puerta.
2 puertas.
1 balda fija.
4 baldas.

Module colonne avec porte.
2 portes.
1 étagère fixe.
4 étagères.

Availability / disponibilidad / disponibilité:



61 depth / profundidad / profondeur

SAP	Code Código Code	Width Ancho Largeur	Opening Apertura Ouverture											
				0	1	2	3	4	5	6	7	8	9	10
700021401	CP 0519	76,2	-	748	885	-	1009	1064	1123	-	-	-	-	-
700021402	CP 0519	80	-	763	903	-	1031	1083	1146	-	-	-	-	-
700021403	CP 0519	90	-	786	935	-	1073	1117	1188	-	-	-	-	-
700021404	CP 0519	100	-	808	973	-	1122	1175	1253	-	-	-	-	-
700021405	CP 0519	120	-	876	1059	-	1230	1291	1361	-	-	-	-	-

45 depth / profundidad / profondeur

SAP	Code Código Code	Width Ancho Largeur	Opening Apertura Ouverture											
				0	1	2	3	4	5	6	7	8	9	10
700021406	CP 0520	76,2	-	676	815	-	934	988	1048	-	-	-	-	-
700021407	CP 0520	80	-	700	842	-	965	1017	1080	-	-	-	-	-
700021408	CP 0520	90	-	719	870	-	1003	1057	1118	-	-	-	-	-
700021409	CP 0520	100	-	738	905	-	1049	1112	1180	-	-	-	-	-
700021410	CP 0520	120	-	781	967	-	1131	1190	1262	-	-	-	-	-

35 depth / profundidad / profondeur

SAP	Code Código Code	Width Ancho Largeur	Opening Apertura Ouverture											
				0	1	2	3	4	5	6	7	8	9	10
700021411	CP 0521	76,2	-	629	768	-	884	938	998	-	-	-	-	-
700021412	CP 0521	80	-	641	784	-	904	955	1018	-	-	-	-	-
700021413	CP 0521	90	-	664	816	-	946	990	1060	-	-	-	-	-
700021414	CP 0521	100	-	683	852	-	992	1045	1123	-	-	-	-	-
700021415	CP 0521	120	-	732	918	-	1079	1137	1210	-	-	-	-	-

Tower units
Columnas
Colonnes

Tower unit with door
Módulo columna con puerta
Module colonne avec porte

H. 198

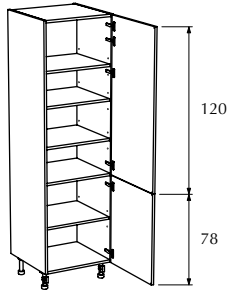

Tower unit with door.
2 doors.
1 fixed shelf.
4 shelves.

Módulo columna con puerta.
2 puertas.
1 balda fija.
4 baldas.

Module colonne avec porte.
2 portes.
1 étagère fixe.
4 étagères.

Availability / disponibilidad / disponibilité:

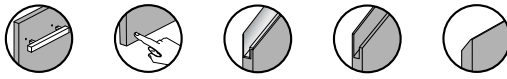

61 depth / profundidad / profondeur

SAP	Code Código Code	Width Ancho Largeur	Opening Apertura Ouverture											
				0	1	2	3	4	5	6	7	8	9	10
700021416	CP 0522	30	L / R	624	692	-	779	829	878	-	939	-	-	-
700021417	CP 0522	40	L / R	640	720	-	817	863	921	-	1000	-	-	-
700021418	CP 0522	45	L / R	651	736	-	838	883	942	-	1030	-	-	-
700021419	CP 0522	50	L / R	665	754	-	862	904	966	-	1064	-	-	-
700021420	CP 0522	60	L / R	707	821	-	927	987	1050	-	1156	-	-	-

45 depth / profundidad / profondeur

SAP	Code Código Code	Width Ancho Largeur	Opening Apertura Ouverture											
				0	1	2	3	4	5	6	7	8	9	10
700021421	CP 0523	30	L / R	571	641	-	723	773	814	-	882	-	-	-
700021422	CP 0523	40	L / R	591	673	-	766	812	862	-	948	-	-	-
700021423	CP 0523	45	L / R	600	687	-	785	830	881	-	976	-	-	-
700021424	CP 0523	50	L / R	613	704	-	807	850	903	-	1008	-	-	-
700021425	CP 0523	60	L / R	631	735	-	848	898	961	-	1066	-	-	-

35 depth / profundidad / profondeur

SAP	Code Código Code	Width Ancho Largeur	Opening Apertura Ouverture											
				0	1	2	3	4	5	6	7	8	9	10
700021426	CP 0524	30	L / R	538	609	-	688	738	779	-	847	-	-	-
700021427	CP 0524	40	L / R	563	647	-	737	782	832	-	918	-	-	-
700021428	CP 0524	45	L / R	571	659	-	754	799	850	-	945	-	-	-
700021429	CP 0524	50	L / R	582	675	-	775	833	887	-	975	-	-	-
700021430	CP 0524	60	L / R	598	703	-	813	871	926	-	1031	-	-	-

H. 198

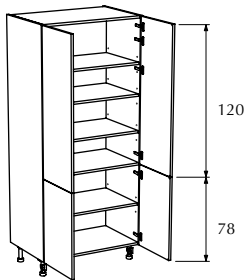

Tower unit with door.
4 doors.
1 fixed shelf.
4 shelves.

Módulo columna con puerta.
4 puertas.
1 balda fija.
4 baldas.

Module colonne avec porte.
4 portes.
1 étagère fixe.
4 étagères.

Availability / disponibilidad / disponibilité:

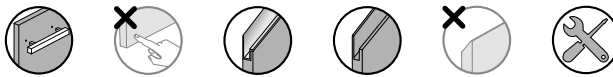

61 depth / profundidad / profondeur

SAP	Code Código Code	Width Ancho Largeur	Opening Apertura Ouverture											
				0	1	2	3	4	5	6	7	8	9	10
700021431	CP 0525	76,2	-	769	956	-	1085	1186	1268	-	1426	-	-	-
700021432	CP 0525	80	-	784	965	-	1115	1207	1306	-	1458	-	-	-
700021433	CP 0525	90	-	806	996	-	1157	1247	1349	-	1519	-	-	-
700021434	CP 0525	100	-	829	1028	-	1199	1309	1417	-	1594	-	-	-
700021435	CP 0525	120	-	897	1119	-	1314	1424	1536	-	1746	-	-	-

45 depth / profundidad / profondeur

SAP	Code Código Code	Width Ancho Largeur	Opening Apertura Ouverture											
				0	1	2	3	4	5	6	7	8	9	10
700021436	CP 0526	76,2	-	697	871	-	1010	1111	1204	-	1338	-	-	-
700021437	CP 0526	80	-	720	904	-	1049	1140	1240	-	1405	-	-	-
700021438	CP 0526	90	-	739	932	-	1087	1177	1279	-	1462	-	-	-
700021439	CP 0526	100	-	758	960	-	1126	1223	1318	-	1505	-	-	-
700021440	CP 0526	120	-	802	1028	-	1215	1323	1423	-	1631	-	-	-

35 depth / profundidad / profondeur

SAP	Code Código Code	Width Ancho Largeur	Opening Apertura Ouverture											
				0	1	2	3	4	5	6	7	8	9	10
700021441	CP 0527	76,2	-	649	826	-	969	1061	1143	-	1299	-	-	-
700021442	CP 0527	80	-	662	848	-	987	1079	1168	-	1317	-	-	-
700021443	CP 0527	90	-	684	879	-	1030	1120	1210	-	1377	-	-	-
700021444	CP 0527	100	-	704	908	-	1069	1154	1249	-	1434	-	-	-
700021445	CP 0527	120	-	752	980	-	1163	1258	1359	-	1579	-	-	-

H. 198

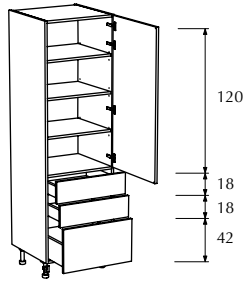

Tower unit with door.
1 door.
2 drawers.
1 deep drawer.
1 fixed shelf.
3 shelves.

Módulo columna con puerta.
1 puerta.
2 cajones.
1 gaveta.
1 balda fija.
3 baldas.

Module colonne avec porte.
1 porte.
2 tiroirs.
1 extractible.
1 étagère fixe.
3 étagères.

Availability / disponibilidad / disponibilité:

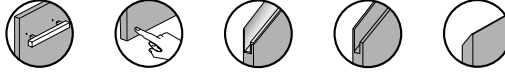

61 depth / profundidad / profondeur

SAP	Code Código Code	Width Ancho Largeur	Opening Apertura Ouverture	0	1	2	3	4	5	6	7	8	9	10
				700021446	CCE 0528	30	L / R	1092	1194	-	1327	1419	1495	-
700021447	CCE 0528	40	L / R	1115	1227	-	1383	1460	1539	-	1669	-	-	-
700021448	CCE 0528	45	L / R	1130	1247	-	1408	1491	1565	-	1673	-	-	-
700021449	CCE 0528	50	L / R	1148	1269	-	1437	1525	1594	-	1712	-	-	-
700021450	CCE 0528	60	L / R	1195	1331	-	1512	1604	1683	-	1820	-	-	-

45 depth / profundidad / profondeur

SAP	Code Código Code	Width Ancho Largeur	Opening Apertura Ouverture	0	1	2	3	4	5	6	7	8	9	10
				700021451	CCE 0529	30	L / R	1059	1163	-	1304	1398	1460	-
700021452	CCE 0529	40	L / R	1089	1203	-	1356	1446	1512	-	1611	-	-	-
700021453	CCE 0529	45	L / R	1102	1220	-	1379	1469	1536	-	1644	-	-	-
700021454	CCE 0529	50	L / R	1118	1241	-	1405	1494	1562	-	1680	-	-	-
700021455	CCE 0529	60	L / R	1144	1281	-	1458	1551	1629	-	1766	-	-	-

H. 198

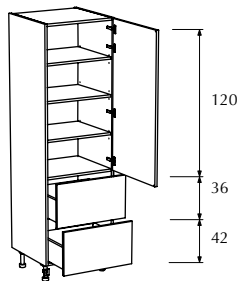

Tower unit with door.
1 door.
2 deep drawers.
1 fixed shelf.
3 shelves.

Módulo columna con puerta.
1 puerta.
2 gavetas.
1 balda fija.
3 baldas.

Module colonne avec porte.
1 porte.
2 extractibles.
1 étagère fixe.
3 étagères.

Availability / disponibilidad / disponibilité:

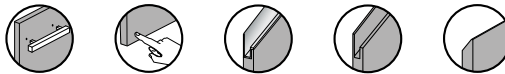

61 depth / profundidad / profondeur

SAP	Code Código Code	Width Ancho Largeur	Opening Apertura Ouverture	0	1	2	3	4	5	6	7	8	9	10
				700021456	CE 0530	30	L / R	985	1066	-	1197	1286	1361	-
700021457	CE 0530	40	L / R	1004	1095	-	1237	1323	1401	-	1497	-	-	-
700021458	CE 0530	45	L / R	1017	1112	-	1260	1346	1424	-	1530	-	-	-
700021459	CE 0530	50	L / R	1033	1133	-	1286	1371	1450	-	1565	-	-	-
700021460	CE 0530	60	L / R	1076	1187	-	1354	1440	1526	-	1660	-	-	-

45 depth / profundidad / profondeur

SAP	Code Código Code	Width Ancho Largeur	Opening Apertura Ouverture	0	1	2	3	4	5	6	7	8	9	10
				700021461	CE 0531	30	L / R	948	1031	-	1158	1248	1323	-
700021462	CE 0531	40	L / R	974	1066	-	1205	1292	1369	-	1479	-	-	-
700021463	CE 0531	45	L / R	985	1081	-	1226	1312	1390	-	1496	-	-	-
700021464	CE 0531	50	L / R	999	1100	-	1250	1336	1415	-	1529	-	-	-
700021465	CE 0531	60	L / R	1021	1134	-	1296	1383	1468	-	1601	-	-	-

Tower units
Columnas
Colonnes

Tower corner unit
Módulo columna rinconero
Module colonne encoignure

H. 198

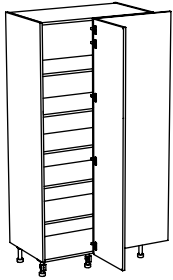

Tower straight corner unit.
1 door.
1 fixed shelf.
4 shelves.
Unit for standard corner filler, 10x10 cm.
Order corner filler separately to insert between add-on units for 90° union.

Módulo columna rinconero recto.
1 puerta.
1 balda fija.
4 baldas.
Módulo para regletas de unión estándar, 10x10 cm.
Solicitar regleta de unión por separado.

Modules colonne encoignure droite.
1 porte.
1 étagère fixe.
4 étagères.
Module pour fileur d'encoignure standard, 10x10 cm.
Commander fileur d'union séparément.

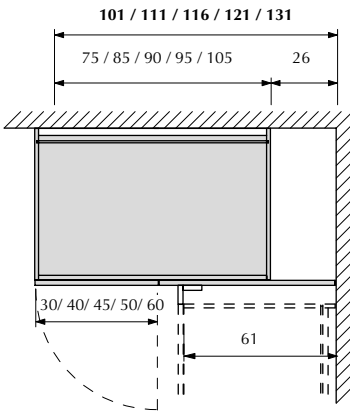

Availability / disponibilidad / disponibilité:

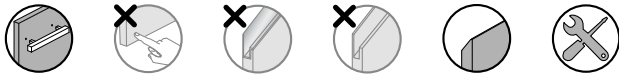

61 depth / profundidad / profondeur

SAP	Code Código Code	Width Ancho Largeur	Opening Apertura Ouverture	0	1	2	3	4	5	6	7	8	9	10
700021466	CRR 0532	101	L / R	751	912	-	1057	1102	1148	-	-	-	-	-
700021467	CRR 0532	111	L / R	780	953	-	1109	1159	1210	-	-	-	-	-
700021468	CRR 0532	116	L / R	791	969	-	1130	1180	1232	-	-	-	-	-
700021469	CRR 0532	121	L / R	802	988	-	1155	1209	1266	-	-	-	-	-
700021470	CRR 0532	131	L / R	830	1026	-	1202	1258	1316	-	-	-	-	-

H. 198

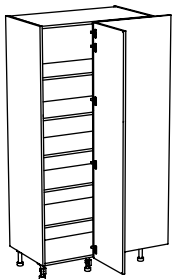

Tower straight corner unit.
1 door.
1 fixed shelf.
4 shelves.
Unit for corner filler with raised door profile 4x4 cm.
Order corner filler separately to insert between add-on units for 90° union.

Módulo columna rinconero recto.
1 puerta.
1 balda fija.
4 baldas.
Módulo para regleta de rincón con perfil de puerta de 4x4 cm.
Solicitar regleta de unión por separado.

Modules colonne encoignure droite.
1 porte.
1 étagère fixe.
4 étagères.
Module pour fileur d'encoignure avec profilé de porte, 4x4 cm.
Commander fileur d'union séparément.

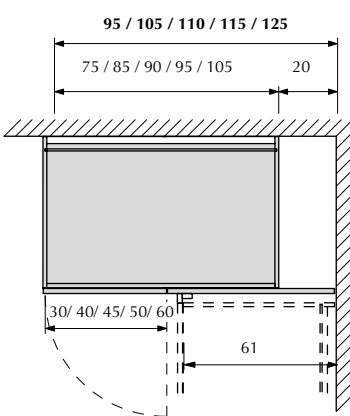

Availability / disponibilidad / disponibilité:



61 depth / profundidad / profondeur

SAP	Code Código Code	Width Ancho Largeur	Opening Apertura Ouverture	0	1	2	3	4	5	6	7	8	9	10
700022017	CRR 0532	95	L / R	751	912	-	1057	1102	1148	-	-	-	-	-
700022018	CRR 0532	105	L / R	780	953	-	1109	1159	1210	-	-	-	-	-
700022019	CRR 0532	110	L / R	791	969	-	1130	1180	1232	-	-	-	-	-
700022020	CRR 0532	115	L / R	802	988	-	1155	1209	1266	-	-	-	-	-
700022021	CRR 0532	125	L / R	830	1026	-	1202	1258	1316	-	-	-	-	-

H. 198

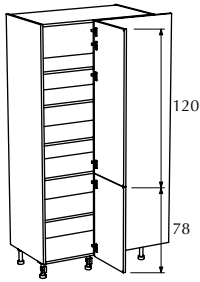

Tower straight corner unit.
2 doors.
1 fixed shelf.
4 shelves.
Unit for standard corner filler, 10x10 cm.
Order corner filler separately to insert between add-on units for 90° union.

Módulo columna rinconero recto.
2 puertas.
1 balda fija.
4 baldas.
Módulo para regletas de unión estándar, 10x10 cm.
Solicitar regleta de unión por separado.

Modules colonne encoignure droite.
2 portes.
1 étagère fixe.
4 étagères.
Module pour fileur d'encoignure standard, 10x10 cm.
Commander fileur d'union séparément.

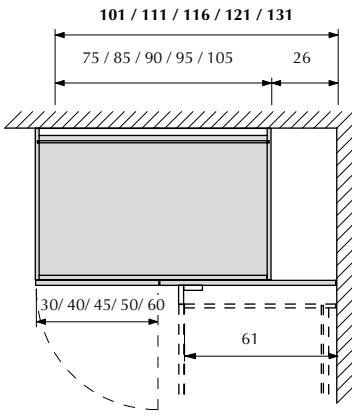

Availability / disponibilidad / disponibilité:

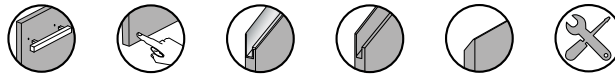

61 depth / profundidad / profondeur

SAP	Code Código Code	Width Ancho Largeur	Opening Apertura Ouverture	0	1	2	3	4	5	6	7	8	9	10
700021471	CRR 0533	101	L / R	761	951	-	1099	1131	1212	-	1365	-	-	-
700021472	CRR 0533	111	L / R	790	992	-	1151	1181	1270	-	1439	-	-	-
700021473	CRR 0533	116	L / R	801	1008	-	1172	1199	1291	-	1469	-	-	-
700021474	CRR 0533	121	L / R	812	1024	-	1193	1217	1313	-	1499	-	-	-
700021475	CRR 0533	131	L / R	841	1065	-	1245	1269	1373	-	1575	-	-	-

H. 198

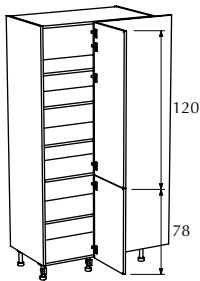

Tower straight corner unit.
2 doors.
1 fixed shelf.
4 shelves.
Unit for corner filler with raised door profile 4x4 cm.
Order corner filler separately to insert between add-on units for 90° union.

Módulo columna rinconero recto.
2 puertas.
1 balda fija.
4 baldas.
Módulo para regleta de rincón con perfil de puerta de 4x4 cm.
Solicitar regleta de unión por separado.

Modules colonne encoignure droite.
2 portes.
1 étagère fixe.
4 étagères.
Module pour fileur d'encoignure avec profilé de porte, 4x4 cm.
Commander fileur d'union séparément.

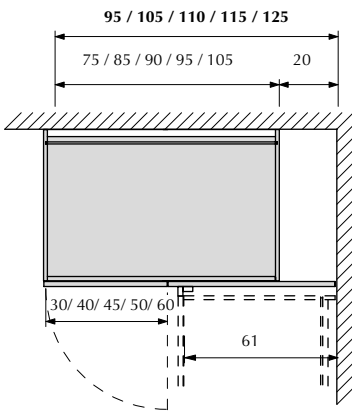

Availability / disponibilidad / disponibilité:

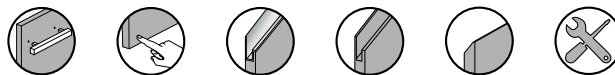

61 depth / profundidad / profondeur

SAP	Code Código Code	Width Ancho Largeur	Opening Apertura Ouverture	0	1	2	3	4	5	6	7	8	9	10
700022022	CRR 0533	95	L / R	761	951	-	1099	1131	1212	-	1365	-	-	-
700022023	CRR 0533	105	L / R	790	992	-	1151	1181	1270	-	1439	-	-	-
700022024	CRR 0533	110	L / R	801	1008	-	1172	1199	1291	-	1469	-	-	-
700022025	CRR 0533	115	L / R	812	1024	-	1193	1217	1313	-	1499	-	-	-
700022026	CRR 0533	125	L / R	841	1065	-	1245	1269	1373	-	1575	-	-	-

H. 198

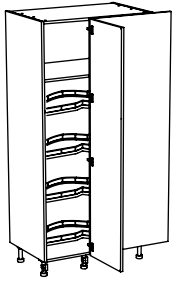

Tower straight corner unit.
1 door.
1 shelf.
4 Rotating drawers shelves.
Unit for standard corner filler, 10x10 cm.
Order corner filler separately to insert between add-on units for 90° union.

Módulo columna rinconero recto.
1 puerta.
1 balda.
4 Baldas giratorias y extraíbles.
Módulo para regletas de unión estándar, 10x10 cm.
Solicitar regleta de unión por separado.

Modules colonne encoignure droite.
1 porte.
1 étagère.
4 Étagères pivotantes extractibles.
Module pour fileur d'encoignure standard, 10x10 cm.
Commander fileur d'union séparément.

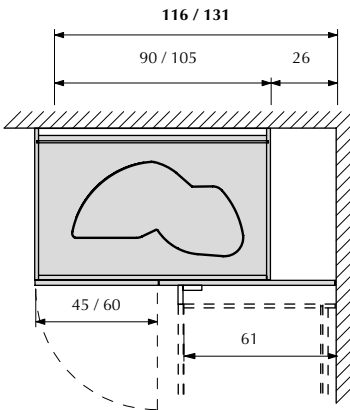

Availability / disponibilidad / disponibilité:

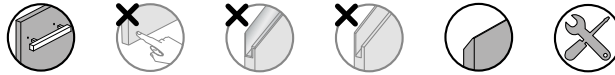

61 depth / profundidad / profondeur

SAP	Code Código Code	Width Ancho Largeur	Opening Apertura Ouverture											
				0	1	2	3	4	5	6	7	8	9	10
700021476	CRR 0534	116	L / R	2477	2612	-	2893	2976	3062	-	-	-	-	-
700021478	CRR 0534	131	L / R	2698	2846	-	3155	3247	3342	-	-	-	-	-

H. 198

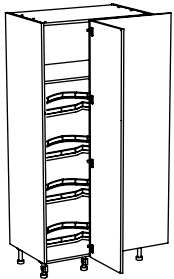

Tower straight corner unit.
1 door.
1 shelf.
4 Rotating drawers shelves.
Unit for corner filler with raised door profile 4x4 cm.
Order corner filler separately to insert between add-on units for 90° union.

Módulo columna rinconero recto.
1 puerta.
1 balda.
4 Baldas giratorias y extraíbles.
Módulo para regleta de rincón con perfil de puerta de 4x4 cm.
Solicitar regleta de unión por separado.

Modules colonne encoignure droite.
1 porte.
1 étagère.
4 Étagères pivotantes extractibles.
Module pour fileur d'encoignure avec profilé de porte, 4x4 cm.
Commander fileur d'union séparément.

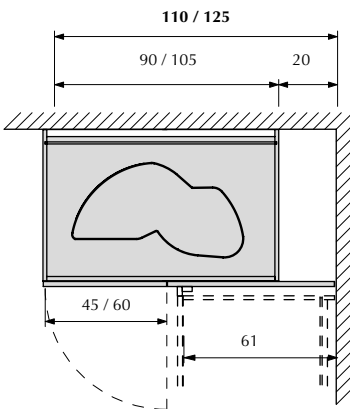

Availability / disponibilidad / disponibilité:

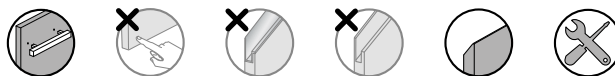

61 depth / profundidad / profondeur

SAP	Code Código Code	Width Ancho Largeur	Opening Apertura Ouverture											
				0	1	2	3	4	5	6	7	8	9	10
700022027	CRR 0534	110	L / R	2477	2612	-	2893	2976	3062	-	-	-	-	-
700022029	CRR 0534	125	L / R	2698	2846	-	3155	3247	3342	-	-	-	-	-

H. 198

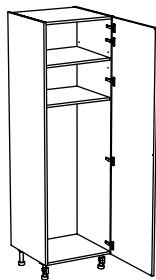

Tower broom and cleaning product unit.
1 door.
1 fixed shelf.
1 shelf.

Módulo columna para útiles de limpieza.
1 puerta.
1 balda fija.
1 balda.

Colonne pour utensiles de nettoyage.
1 porte.
1 étagère fixe.
1 étagère

Availability / disponibilidad / disponibilité:



61 depth / profundidad / profondeur

SAP	Code Código Code	Width Ancho Largeur	Opening Apertura Ouverture											
				0	1	2	3	4	5	6	7	8	9	10
700021479	CUL 0535	30	L / R	529	582	-	648	674	697	-	-	-	-	-
700021480	CUL 0535	40	L / R	537	603	-	678	704	735	-	-	-	-	-
700021481	CUL 0535	45	L / R	545	615	-	695	717	752	-	-	-	-	-
700021482	CUL 0535	50	L / R	555	634	-	719	746	785	-	-	-	-	-
700021483	CUL 0535	60	L / R	583	671	-	766	800	832	-	-	-	-	-

45 depth / profundidad / profondeur

SAP	Code Código Code	Width Ancho Largeur	Opening Apertura Ouverture											
				0	1	2	3	4	5	6	7	8	9	10
700021484	CUL 0536	30	L / R	480	535	-	597	623	647	-	-	-	-	-
700021485	CUL 0536	40	L / R	495	562	-	634	660	692	-	-	-	-	-
700021486	CUL 0536	45	L / R	502	574	-	650	679	708	-	-	-	-	-
700021487	CUL 0536	50	L / R	511	591	-	673	706	739	-	-	-	-	-
700021488	CUL 0536	60	L / R	524	614	-	705	731	771	-	-	-	-	-

35 depth / profundidad / profondeur

SAP	Code Código Code	Width Ancho Largeur	Opening Apertura Ouverture											
				0	1	2	3	4	5	6	7	8	9	10
700021489	CUL 0537	30	L / R	454	509	-	570	596	619	-	-	-	-	-
700021490	CUL 0537	40	L / R	472	540	-	611	637	668	-	-	-	-	-
700021491	CUL 0537	45	L / R	478	551	-	626	648	683	-	-	-	-	-
700021492	CUL 0537	50	L / R	487	567	-	648	680	713	-	-	-	-	-
700021493	CUL 0537	60	L / R	498	588	-	678	710	744	-	-	-	-	-

H. 198

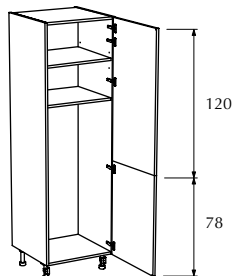

Tower broom and cleaning product unit.
2 doors.
1 fixed shelf.
1 shelf.

Módulo columna para útiles de limpieza.
2 puertas.
1 balda fija.
1 balda.

Colonne pour utensiles de nettoyage.
2 portes.
1 étagère fixe.
1 étagère

Availability / disponibilidad / disponibilité:

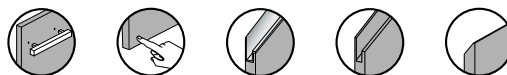

61 depth / profundidad / profondeur

SAP	Code Código Code	Width Ancho Largeur	Opening Apertura Ouverture											
				0	1	2	3	4	5	6	7	8	9	10
700021494	CUL 0538	30	L / R	544	615	-	695	745	786	-	853	-	-	-
700021495	CUL 0538	40	L / R	552	636	-	732	771	821	-	907	-	-	-
700021496	CUL 0538	45	L / R	560	648	-	743	787	838	-	933	-	-	-
700021497	CUL 0538	50	L / R	571	664	-	763	806	859	-	954	-	-	-
700021498	CUL 0538	60	L / R	598	703	-	814	855	918	-	1040	-	-	-

45 depth / profundidad / profondeur

SAP	Code Código Code	Width Ancho Largeur	Opening Apertura Ouverture											
				0	1	2	3	4	5	6	7	8	9	10
700021499	CUL 0539	30	L / R	496	569	-	650	695	735	-	802	-	-	-
700021500	CUL 0539	40	L / R	511	596	-	682	727	777	-	862	-	-	-
700021501	CUL 0539	45	L / R	517	607	-	698	756	808	-	888	-	-	-
700021502	CUL 0539	50	L / R	527	621	-	717	774	828	-	916	-	-	-
700021503	CUL 0539	60	L / R	540	647	-	752	809	872	-	978	-	-	-

35 depth / profundidad / profondeur

SAP	Code Código Code	Width Ancho Largeur	Opening Apertura Ouverture											
				0	1	2	3	4	5	6	7	8	9	10
700021504	CUL 0540	30	L / R	469	544	-	622	667	708	-	774	-	-	-
700021505	CUL 0540	40	L / R	488	574	-	658	704	753	-	838	-	-	-
700021506	CUL 0540	45	L / R	493	585	-	673	718	769	-	863	-	-	-
700021507	CUL 0540	50	L / R	502	598	-	692	748	802	-	890	-	-	-
700021508	CUL 0540	60	L / R	514	622	-	725	781	845	-	951	-	-	-

Tower units
Columnas
Colonnes

Tower unit with interior equipment
Módulo columna con equipamiento interior
Module colonne avec équipement intérieur

H. 198

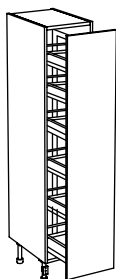

Tower pull-out larder unit.
1 door.
1 pull-out unit with 6 basket with non-slip base and metal structure.

Columna provisiones extraíble.
1 puerta.
1 armazón extraíble con 6 cestas con base antideslizante y estructura metálica.

Colonne bac à provisions extractible
1 porte.
1 structure extractible avec 6 paniers avec base anti-dérapant et structure métallique.

Availability / disponibilidad / disponibilité:



61 depth / profundidad / profondeur

SAP	Code Código Code	Width Ancho Largeur	Opening Apertura Ouverture	0	1	2	3	4	5	6	7	8	9	10
				700021509	CEQ 0541	30	-	2100	2114	-	2291	2362	2430	-

H. 198

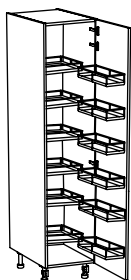

Tower larder unit Tandem.
1 door.
1 fixed structure with 6 baskets with non-slip base and metal structure on door.
1 pull-out unit with 6 baskets with non-slip base and metal structure.

Columna provisiones Tandem.
1 puerta.
1 armazón fijo con 6 cestas con base antideslizante y estructura metálica en la puerta.
1 armazón extraíble con 6 cestas con base antiadherente y estructura metálica.

Colonne bac à provisions Tandem.
1 porte.
1 structure fixe avec 6 paniers avec base anti-dérapant et structure métallique sur la porte.
1 structure extractible avec 6 paniers avec base anti-dérapant et structure métallique.

Availability / disponibilidad / disponibilité:



61 depth / profundidad / profondeur

SAP	Code Código Code	Width Ancho Largeur	Opening Apertura Ouverture	0	1	2	3	4	5	6	7	8	9	10
				700021510	CEQ 0542	45	-	2674	2691	-	2921	2998	3091	-
700021511	CEQ 0542	60	-	2881	2910	-	3169	3247	3357	-	-	-	-	-

H. 198

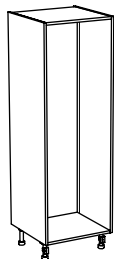

Carcass for tower unit kit for oven and microwave.

Comments:

Must be filled with units for oven and microwave tower unit kit.
See instructions on chapter 01.

Casco para kit columna de horno y microondas.

Observaciones:

Se debe completar con módulos para kit columna horno y microondas.
Ver instrucciones en capítulos 01.

Caisson pour kit colonne pour four et micro-ondes.

Remarques:

Doit être complétés avec les modules pour kit colonne four et micro-ondes.
Voir instructions en chapitre 01.

Availability / disponibilidad / disponibilité:



61 depth / profundidad / profondeur

SAP	Code Código Code	Width Ancho Largeur	Opening Apertura Ouverture	Carcass colour Color de casco Couleur de caisson
700021895	CHM 0625	60	-	404
700021896	CHM 0625	68,6	-	409
700021897	CHM 0625	76,2	-	413
700021898	CHM 0625	90	-	420
700021899	CHM 0625	91,5	-	421

H. 198

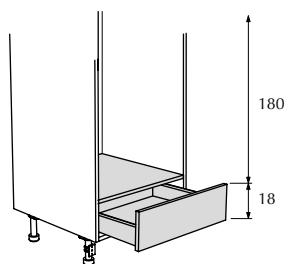

Lower unit with drawers for kit for oven and microwave.

1 drawer.
1 top shelf.
1 back panel.

H 18

Módulo inferior con cajones para kit columna de horno y microondas.

1 cajón.
1 techo.
1 trasera.

H 18

Module inférieur avec tiroirs pour four et micro-ondes.

1 tiroir.
1 joue superieure.
1 panneau arrière.

H 18

Availability / disponibilidad / disponibilité:

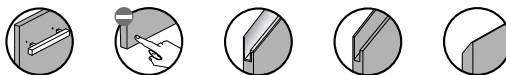

61 depth / profundidad / profondeur

SAP	Code Código Code	Width Ancho Largeur	Opening Apertura Ouverture											
				0	1	2	3	4	5	6	7	8	9	10
700021915	CHM 0629	60	-	285	308	-	353	376	387	-	407	-	-	-
700021916	CHM 0629	68,6	-	295	318	-	365	391	402	-	421	-	-	-
700021917	CHM 0629	76,2	-	303	327	-	376	403	413	-	433	-	-	-
700021918	CHM 0629	90	-	312	338	-	389	415	426	-	448	-	-	-
700021919	CHM 0629	91,5	-	313	339	-	390	418	431	-	450	-	-	-

H. 198

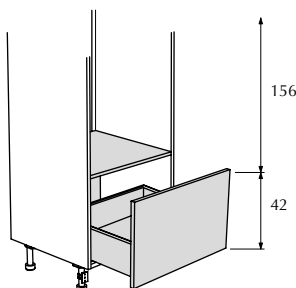

Lower unit with drawers for kit for oven and microwave.

1 deep drawer.
1 top shelf.
1 back panel.

H 42

Módulo inferior con cajones para kit columna de horno y microondas.

1 gaveta.
1 techo.
1 trasera.

H 42

Module inférieur avec tiroirs pour four et micro-ondes.

1 extractible.
1 joue superieure.
1 panneau arrière.

H 42

Availability / disponibilidad / disponibilité:

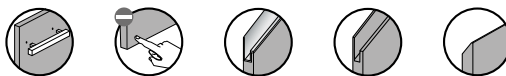

61 depth / profundidad / profondeur

SAP	Code Código Code	Width Ancho Largeur	Opening Apertura Ouverture											
				0	1	2	3	4	5	6	7	8	9	10
700021920	CHM 0630	60	-	332	361	-	407	435	455	-	486	-	-	-
700021921	CHM 0630	68,6	-	342	372	-	421	450	469	-	504	-	-	-
700021922	CHM 0630	76,2	-	353	388	-	440	470	492	-	530	-	-	-
700021923	CHM 0630	90	-	363	400	-	455	484	504	-	542	-	-	-
700021924	CHM 0630	91,5	-	364	401	-	457	488	508	-	544	-	-	-

H. 198

Lower unit with door for kit for oven and microwave.
1 door.
1 shelf.
1 top shelf.
1 back panel.
H 60

Módulo inferior con puerta para kit columna de horno y microondas.
1 puerta.
1 balda.
1 techo.
1 trasera.
H 60

Module inférieur avec porte pour four et micro-ondes.
1 porte.
1 étagère.
1 joue supérieure.
1 panneau arrière.
H 60

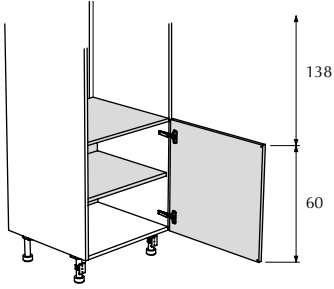

Availability / disponibilidad / disponibilité:

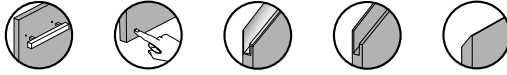

61 depth / profundidad / profondeur

SAP	Code Código Code	Width Ancho Largeur	Opening Apertura Ouverture											
				0	1	2	3	4	5	6	7	8	9	10
700021925	CHM 0631	60	-	172	216	-	257	278	297	-	329	-	-	-
700021926	CHM 0631	68,6	-	178	224	-	268	291	314	-	351	-	-	-
700021927	CHM 0631	76,2	-	183	231	-	273	301	324	-	358	-	-	-

H. 198

Lower unit with drawers for kit for oven and microwave.
1 deep drawer.
1 top shelf.
1 back panel.
H 60

Módulo inferior con cajones para kit columna de horno y microondas.
1 gaveta.
1 techo.
1 trasera.
H 60

Module inférieur avec tiroirs pour four et micro-ondes.
1 extractible.
1 jeu supérieur.
1 panneau arrière.
H 60

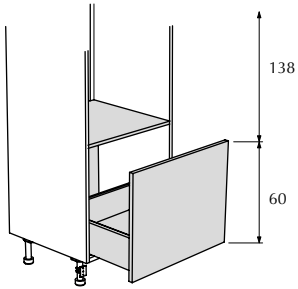

Availability / disponibilidad / disponibilité:

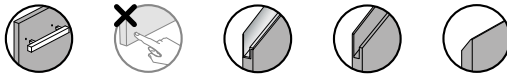

61 depth / profundidad / profondeur

SAP	Code Código Code	Width Ancho Largeur	Opening Apertura Ouverture											
				0	1	2	3	4	5	6	7	8	9	10
700021928	CHM 0632	60	-	338	375	-	423	452	475	-	511	-	-	-
700021929	CHM 0632	68,6	-	348	388	-	439	469	491	-	527	-	-	-
700021930	CHM 0632	76,2	-	357	398	-	453	483	505	-	545	-	-	-
700021931	CHM 0632	90	-	367	412	-	471	507	529	-	566	-	-	-
700021932	CHM 0632	91,5	-	368	414	-	473	509	531	-	569	-	-	-

H. 198

Lower unit with drawers for kit for oven and microwave.
1 drawer.
1 deep drawer.
1 top shelf.
1 back panel.
H 60

Módulo inferior con cajones para kit columna de horno y microondas.
1 cajón.
1 gaveta.
1 techo.
1 trasera.
H 60

Module inférieur avec tiroirs pour four et micro-ondes.
1 tiroir.
1 extractible.
1 joue supérieure.
1 panneau arrière.
H 60

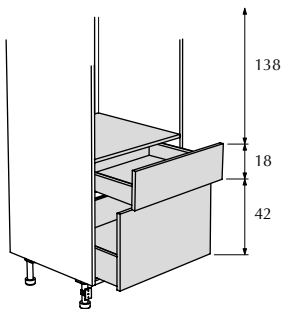

Availability / disponibilidad / disponibilité:



61 depth / profundidad / profondeur

SAP	Code Código Code	Width Ancho Largeur	Opening Apertura Ouverture											
				0	1	2	3	4	5	6	7	8	9	10
700021933	CHM 0633	60	-	504	560	-	637	692	725	-	771	-	-	-
700021934	CHM 0633	68,6	-	521	579	-	660	721	748	-	792	-	-	-
700021935	CHM 0633	76,2	-	536	599	-	691	746	776	-	817	-	-	-
700021936	CHM 0633	90	-	551	618	-	702	768	801	-	850	-	-	-
700021937	CHM 0633	91,5	-	552	620	-	705	770	804	-	853	-	-	-

H. 198

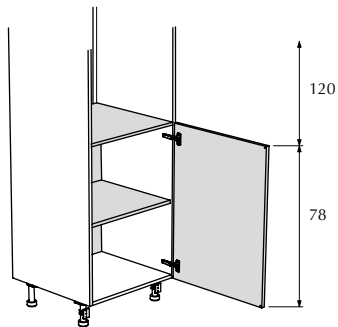

Lower unit with door for kit for oven and microwave.
1 door.
1 shelf.
1 top shelf.
1 back panel.
H 78

Módulo inferior con puerta para kit columna de horno y microondas.
1 puerta.
1 balda.
1 techo.
1 trasera.
H 78

Module inférieur avec porte pour four et micro-ondes.
1 porte.
1 étagère.
1 joue supérieure.
1 panneau arrière.
H 78

Availability / disponibilidad / disponibilité:

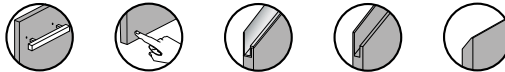

61 depth / profundidad / profondeur

SAP	Code Código Code	Width Ancho Largeur	Opening Apertura Ouverture	0	1	2	3	4	5	6	7	8	9	10
				700021938	CHM 0634	60	-	175	225	-	263	288	311	-
700021939	CHM 0634	68,6	-	181	234	-	276	301	327	-	371	-	-	-
700021940	CHM 0634	76,2	-	187	242	-	287	312	339	-	388	-	-	-

H. 198

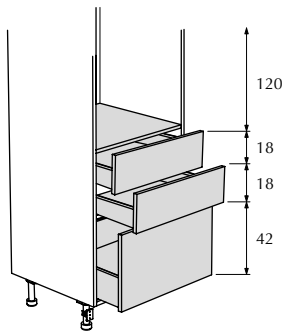

Lower unit with drawers for kit for oven and microwave.
2 drawers.
1 deep drawer.
1 top shelf.
1 back panel.
H 78

Módulo inferior con cajones para kit columna de horno y microondas.
2 cajones.
1 gaveta.
1 techo.
1 trasera.
H 78

Module inférieur avec tiroirs pour four et micro-ondes.
2 tiroirs.
1 extractible.
1 joue supérieure.
1 panneau arrière.
H 78

Availability / disponibilidad / disponibilité:

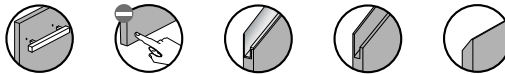

61 depth / profundidad / profondeur

SAP	Code Código Code	Width Ancho Largeur	Opening Apertura Ouverture	0	1	2	3	4	5	6	7	8	9	10
				700021941	CHM 0635	60	-	674	758	-	853	931	974	-
700021942	CHM 0635	68,6	-	697	784	-	884	971	1024	-	1092	-	-	-
700021943	CHM 0635	76,2	-	718	811	-	916	1005	1051	-	1124	-	-	-
700021944	CHM 0635	90	-	740	839	-	951	1036	1077	-	1159	-	-	-
700021945	CHM 0635	91,5	-	743	841	-	955	1046	1100	-	1186	-	-	-

H. 198

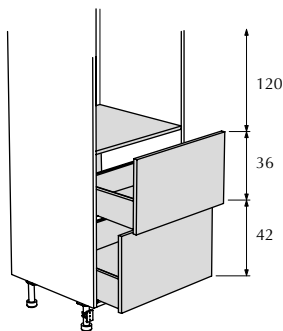

Lower unit with drawers for kit for oven and microwave.
2 deep drawers.
1 top shelf.
1 back panel.
H 78

Módulo inferior con cajones para kit columna de horno y microondas.
2 gavetas.
1 techo.
1 trasera.
H 78

Module inférieur avec tiroirs pour four et micro-ondes.
2 extractibles.
1 joue supérieure.
1 panneau arrière.
H 78

Availability / disponibilidad / disponibilité:

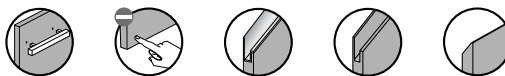

61 depth / profundidad / profondeur

SAP	Code Código Code	Width Ancho Largeur	Opening Apertura Ouverture	0	1	2	3	4	5	6	7	8	9	10
				700021946	CHM 0636	60	-	550	610	-	690	764	826	-
700021947	CHM 0636	68,6	-	567	630	-	735	800	852	-	934	-	-	-
700021948	CHM 0636	76,2	-	582	651	-	761	824	874	-	952	-	-	-
700021949	CHM 0636	90	-	599	676	-	794	855	906	-	1004	-	-	-
700021950	CHM 0636	91,5	-	601	678	-	797	864	917	-	1008	-	-	-

H. 198

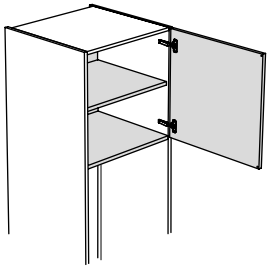

Upper unit with door for kit for oven and microwave.
1 door.
1 Shelf.
1 base shelf.
1 back panel.
Variable height.
Minimum height, 30 cm.

Módulo superior con puerta para kit columna de horno y microondas.
1 puerta.
1 balda.
1 base.
1 trasera.
Altura variable.
Altura mínima, 30 cm.

Modules supérieur avec porte pour four et micro-ondes.
1 porte.
1 étagère.
1 joue inférieure.
1 panneau arrière.
Hauteur variable.
Hauteur minimale de 30 cm.

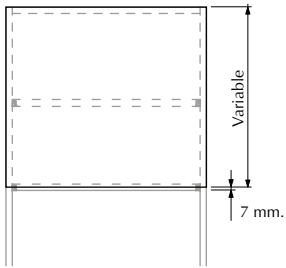

Availability / disponibilidad / disponibilité:

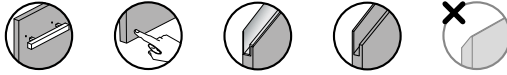

61 depth / profundidad / profondeur

SAP	Code Código Code	Width Ancho Largeur	Opening Apertura Ouverture											
				0	1	2	3	4	5	6	7	8	9	10
700021951	CHM 0637	60	-	177	230	-	273	300	327	-	368	-	-	-
700021952	CHM 0637	68,6	-	184	244	-	290	320	352	-	400	-	-	-
700021953	CHM 0637	76,2	-	191	254	-	304	335	367	-	420	-	-	-

H. 198

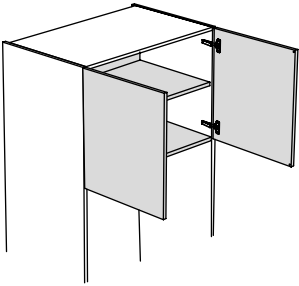

Upper unit with door for kit for oven and microwave.
2 doors.
1 Shelf.
1 base shelf.
1 back panel.
Variable height.
Minimum height, 30 cm.

Módulo superior con puerta para kit columna de horno y microondas.
2 puertas.
1 balda.
1 base.
1 trasera.
Altura variable.
Altura mínima, 30 cm.

Modules supérieur avec porte pour four et micro-ondes.
2 portes.
1 étagère.
1 joue inférieure.
1 panneau arrière.
Hauteur variable.
Hauteur minimale de 30 cm.

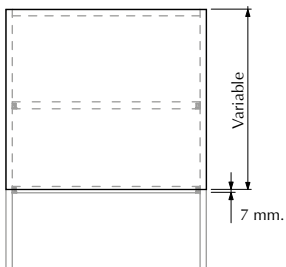

Availability / disponibilidad / disponibilité:

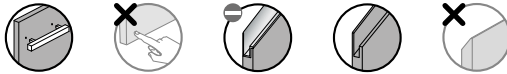

61 depth / profundidad / profondeur

SAP	Code Código Code	Width Ancho Largeur	Opening Apertura Ouverture											
				0	1	2	3	4	5	6	7	8	9	10
700021954	CHM 0638	76,2	-	207	299	-	367	409	457	-	518	-	-	-
700021955	CHM 0638	90	-	217	315	-	379	425	476	-	542	-	-	-
700021956	CHM 0638	91,5	-	218	325	-	397	450	498	-	576	-	-	-

H. 198

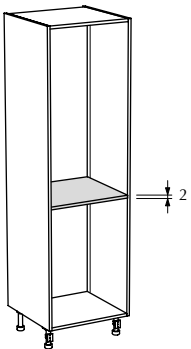

Shelf for kit for oven and microwave.
1 shelf.
H 2

Balda para kit columna de horno y microondas.
1 balda.
H 2

Étagère pour four et micro-ondes.
1 étagère.
H 2

61 depth / profundidad / profondeur

SAP	Code Código Code	Width Ancho Largeur	Opening Apertura Ouverture	Carcass colour
				Color de casco Couleur de caisson
700021957	CHM 0639	60	-	66
700021958	CHM 0639	68,6	-	69
700021959	CHM 0639	76,2	-	71
700021960	CHM 0639	90	-	74
700021961	CHM 0639	91,5	-	74

Tower units
Columnas
Colonnes

Tower unit for fridge
Módulo columna para frigorífico
Module colonne pour réfrigérateur

H. 198

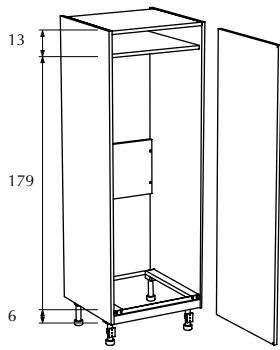

Tower unit for fridge.
1 door.
1 structure with ventilation grille.
1 shelf.
1 back panel.
WITHOUT hinges.

Columna de frigorífico.
1 puerta.
1 estructura con rejilla de ventilación.
1 balda.
1 trasera.
SIN bisagras.

Colonne réfrigérateur.
1 porte.
1 structure avec grille d'aération.
1 étagère.
1 panneau arrière.
SANS charnières.

Availability / disponibilidad / disponibilité:

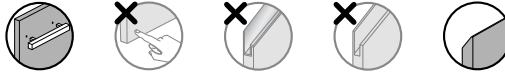

61 depth / profundidad / profondeur

SAP	Code Código Code	Width Ancho Largeur	Opening Apertura Ouverture											
				0	1	2	3	4	5	6	7	8	9	10
700021964	CFS 0643	60	-	613	700	-	798	832	864	-	-	-	-	-

H. 198

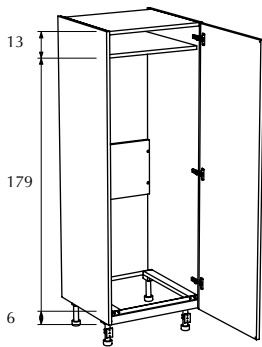

Tower unit for fridge.
1 door.
1 structure with ventilation grille.
1 shelf.
1 back panel.
WITH hinges.

Columna de frigorífico.
1 puerta.
1 estructura con rejilla de ventilación.
1 balda.
1 trasera.
CON bisagras.

Colonne réfrigérateur.
1 porte.
1 structure avec grille d'aération.
1 étagère.
1 panneau arrière.
AVEC charnières.

Availability / disponibilidad / disponibilité:

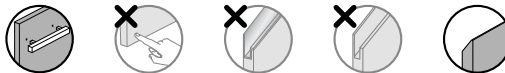

61 depth / profundidad / profondeur

SAP	Code Código Code	Width Ancho Largeur	Opening Apertura Ouverture											
				0	1	2	3	4	5	6	7	8	9	10
700021965	CF 0644	60	-	613	700	-	798	832	864	-	-	-	-	-

H. 198

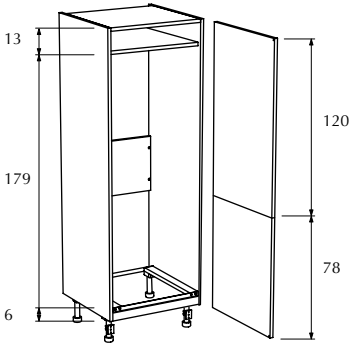

Tower unit for fridge.
2 doors.
1 structure with ventilation grille.
1 shelf.
1 back panel.
WITHOUT hinges.

Columna de frigorífico.
2 puertas.
1 estructura con rejilla de ventilación.
1 balda.
1 trasera.
SIN bisagras.

Colonne réfrigérateur.
2 portes.
1 structure avec grille d'aération.
1 étagère.
1 panneau arrière.
SANS charnières.

Availability / disponibilidad / disponibilité:

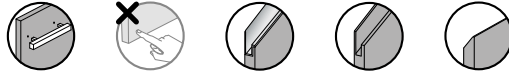

61 depth / profundidad / profondeur

SAP	Code Código Code	Width Ancho Largeur	Opening Apertura Ouverture	0	1	2	3	4	5	6	7	8	9	10
				700021966	CFS 0645	60	-	629	732	-	846	904	967	-

H. 198

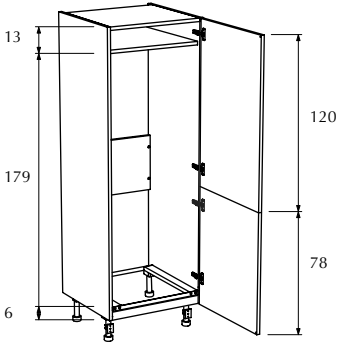

Tower unit for fridge.
2 doors.
1 structure with ventilation grille.
1 shelf.
1 back panel.
WITH hinges.

Columna de frigorífico.
2 puertas.
1 estructura con rejilla de ventilación.
1 balda.
1 trasera.
CON bisagras.

Colonne réfrigérateur.
2 portes.
1 structure avec grille d'aération.
1 étagère.
1 panneau arrière.
AVEC charnières.

Availability / disponibilidad / disponibilité:

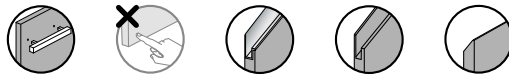

61 depth / profundidad / profondeur

SAP	Code Código Code	Width Ancho Largeur	Opening Apertura Ouverture	0	1	2	3	4	5	6	7	8	9	10
				700021967	CF 0646	60	L / R	629	732	-	846	904	967	-

Tower units
Columnas
Colonnes

Tower unit for fridge
Módulo columna para frigorífico
Module colonne pour réfrigérateur

H. 198

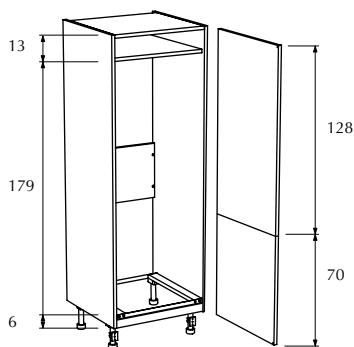

Tower unit for fridge.
2 doors.
1 structure with ventilation grille.
1 shelf.
1 back panel.
WITHOUT hinges.

Columna de frigorífico.
2 puertas.
1 estructura con rejilla de ventilación.
1 balda.
1 trasera.
SIN bisagras.

Colonne réfrigérateur.
2 portes.
1 structure avec grille d'aération.
1 étagère.
1 panneau arrière.
SANS charnières.

Availability / disponibilidad / disponibilité:

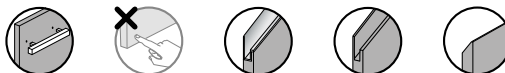

61 depth / profundidad / profondeur

SAP	Code Código Code	Width Ancho Largeur	Opening Apertura Ouverture	0	1	2	3	4	5	6	7	8	9	10
				700021968	CFS 0647	60	-	629	732	-	846	904	967	-

H. 198

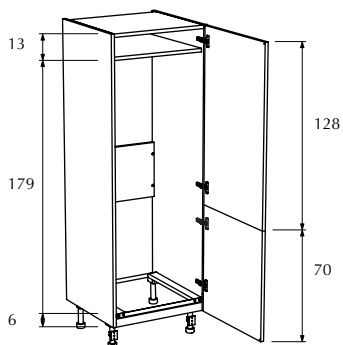

Tower unit for fridge.
2 doors.
1 structure with ventilation grille.
1 shelf.
1 back panel.
WITH hinges.

Columna de frigorífico.
2 puertas.
1 estructura con rejilla de ventilación.
1 balda.
1 trasera.
CON bisagras.

Colonne réfrigérateur.
2 portes.
1 structure avec grille d'aération.
1 étagère.
1 panneau arrière.
AVEC charnières.

Availability / disponibilidad / disponibilité:

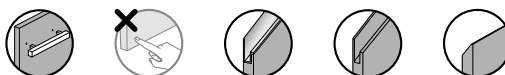



61 depth / profundidad / profondeur

SAP	Code Código Code	Width Ancho Largeur	Opening Apertura Ouverture	0	1	2	3	4	5	6	7	8	9	10
				700021969	CF 0648	60	L / R	629	732	-	846	904	967	-

h. 210

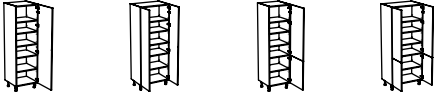
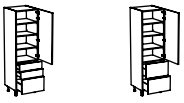
Tower units
Columnas
Colonnes

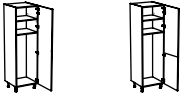
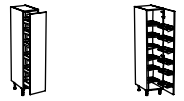
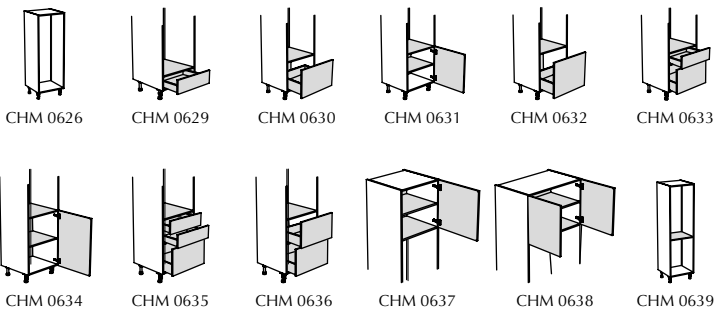
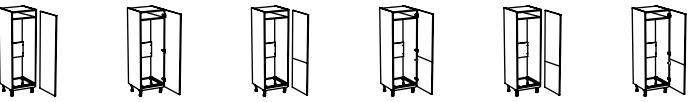
Type of unit Tipo de módulo Type de module	Available measures Medidas disponibles Dimensions disponibles	Available units Módulos disponibles Modules disponibles
<p>p.124 - 125</p> <p>Tower unit with door Columna con puerta Colonne avec porte</p>	<p>Depth / Profundidad / Profondeur (cm.): 35 - 45 - 61</p> <p>Width / Ancho / Largeur (cm.): 30 - 40 - 45 - 50 - 60 (1 door) 76,2 - 80 - 90 - 100 - 120 (2 doors)</p>	 <p>CP 0543 - 0544 - 0545 CP 0546 - 0547 - 0548 CP 0549 - 0550 - 0551 CP 0552 - 0553 - 0554</p>
<p>p.126</p> <p>Tower unit with door and drawer Columna con puerta y cajón Colonne avec porte et tiroir</p>	<p>Depth / Profundidad / Profondeur (cm.): 45 - 61</p> <p>Width / Ancho / Largeur (cm.): 30 - 40 - 45 - 50 - 60</p>	 <p>CCE 0555 - 0556 CE 0557 - 0558</p>
<p>p.127 - 129</p> <p>Tower corner unit Módulo columna rinconero Module colonne encoignure</p>	<p>Depth / Profundidad / Profondeur (cm.): 61</p> <p>Door width / Ancho puerta / Largeur porte: 30 - 40 - 45 - 50 - 60</p>	 <p>CRR 0559 CRR 0560 CRR 0561</p>
<p>p.130</p> <p>Tower broom and cleaning product unit Columna para útiles de limpieza Colonne pour utensiles de nettoyage</p>	<p>Depth / Profundidad / Profondeur (cm.): 35 - 45 - 61</p> <p>Width / Ancho / Largeur (cm.): 30 - 40 - 45 - 50 - 60</p>	 <p>CUL 0562 - 0563 - 0564 CUL 0565 - 0566 - 0567</p>
<p>p.131</p> <p>Tower unit with interior equipment Columna con equipamiento interior Colonne avec équipement intérieur</p>	<p>Depth / Profundidad / Profondeur (cm.): 61</p> <p>Width / Ancho / Largeur (cm.): 30</p>	 <p>CEQ 0568 CEQ 0539</p>
<p>p.132 - 135</p> <p>Tower unit for oven and microwave Columna para horno y microondas Colonne pour four et micro-ondes</p>	<p>Depth / Profundidad / Profondeur (cm.): 61</p> <p>Width / Ancho / Largeur (cm.): 60 - 68,6 - 76,2 - 90 - 91,5</p>	 <p>CHM 0626 CHM 0629 CHM 0630 CHM 0631 CHM 0632 CHM 0633 CHM 0634 CHM 0635 CHM 0636 CHM 0637 CHM 0638 CHM 0639</p>
<p>p.136 - 138</p> <p>Tower unit for fridge Módulo columna para frigorífico Module colonne pour réfrigérateur</p>	<p>Depth / Profundidad / Profondeur (cm.): 61</p> <p>Width / Ancho / Largeur (cm.): 60 - 68,6 - 76,2 - 90 - 91,5</p>	 <p>CFS 0649 CF 0650 CFS 0651 CF 0652 CFS 0653 CF 0654</p>

H. 210

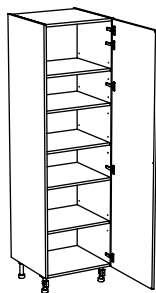

Tower unit with door.
1 door.
1 fixed shelf.
4 shelves.

Módulo columna con puerta.
1 puerta.
1 balda fija.
4 baldas.

Module colonne avec porte.
1 porte.
1 étagère fixe.
4 étagères.

Availability / disponibilidad / disponibilité:



61 depth / profundidad / profondeur

SAP	Code Código Code	Width Ancho Largeur	Opening Apertura Ouverture											
				0	1	2	3	4	5	6	7	8	9	10
700021512	CP 0543	30	L / R	617	673	-	747	779	804	-	-	-	-	-
700021513	CP 0543	40	L / R	633	699	-	783	807	840	-	-	-	-	-
700021514	CP 0543	45	L / R	644	718	-	808	836	874	-	-	-	-	-
700021515	CP 0543	50	L / R	658	738	-	833	857	898	-	-	-	-	-
700021516	CP 0543	60	L / R	700	789	-	896	921	962	-	-	-	-	-

45 depth / profundidad / profondeur

SAP	Code Código Code	Width Ancho Largeur	Opening Apertura Ouverture											
				0	1	2	3	4	5	6	7	8	9	10
700021517	CP 0544	30	L / R	569	627	-	697	729	761	-	-	-	-	-
700021518	CP 0544	40	L / R	590	657	-	738	762	795	-	-	-	-	-
700021519	CP 0544	45	L / R	599	675	-	761	790	827	-	-	-	-	-
700021520	CP 0544	50	L / R	612	692	-	784	816	850	-	-	-	-	-
700021521	CP 0544	60	L / R	630	721	-	823	855	889	-	-	-	-	-

35 depth / profundidad / profondeur

SAP	Code Código Code	Width Ancho Largeur	Opening Apertura Ouverture											
				0	1	2	3	4	5	6	7	8	9	10
700021522	CP 0545	30	L / R	528	586	-	654	686	711	-	-	-	-	-
700021523	CP 0545	40	L / R	553	622	-	700	731	757	-	-	-	-	-
700021524	CP 0545	45	L / R	561	638	-	722	750	788	-	-	-	-	-
700021525	CP 0545	50	L / R	573	654	-	743	775	809	-	-	-	-	-
700021526	CP 0545	60	L / R	589	680	-	779	811	845	-	-	-	-	-

H. 210

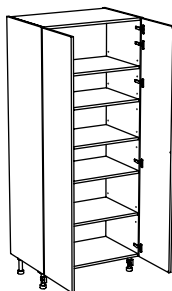

Tower unit with door.
2 doors.
1 fixed shelf.
4 shelves.

Módulo columna con puerta.
2 puertas.
1 balda fija.
4 baldas.

Module colonne avec porte.
2 portes.
1 étagère fixe.
4 étagères.

Availability / disponibilidad / disponibilité:

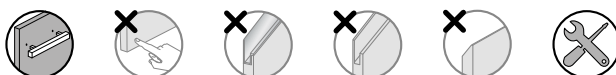

61 depth / profundidad / profondeur

SAP	Code Código Code	Width Ancho Largeur	Opening Apertura Ouverture											
				0	1	2	3	4	5	6	7	8	9	10
700021527	CP 0546	76,2	-	774	915	-	1045	1097	1160	-	-	-	-	-
700021528	CP 0546	80	-	783	928	-	1062	1110	1176	-	-	-	-	-
700021529	CP 0546	90	-	806	967	-	1112	1169	1244	-	-	-	-	-
700021530	CP 0546	100	-	834	1005	-	1161	1210	1293	-	-	-	-	-
700021531	CP 0546	120	-	897	1087	-	1266	1322	1398	-	-	-	-	-

45 depth / profundidad / profondeur

SAP	Code Código Code	Width Ancho Largeur	Opening Apertura Ouverture											
				0	1	2	3	4	5	6	7	8	9	10
700021532	CP 0547	76,2	-	708	851	-	976	1027	1091	-	-	-	-	-
700021533	CP 0547	80	-	725	872	-	1001	1050	1116	-	-	-	-	-
700021534	CP 0547	90	-	745	908	-	1048	1105	1180	-	-	-	-	-
700021535	CP 0547	100	-	770	942	-	1094	1153	1225	-	-	-	-	-
700021536	CP 0547	120	-	808	1000	-	1172	1227	1304	-	-	-	-	-

35 depth / profundidad / profondeur

SAP	Code Código Code	Width Ancho Largeur	Opening Apertura Ouverture											
				0	1	2	3	4	5	6	7	8	9	10
700021537	CP 0548	76,2	-	652	796	-	917	969	1032	-	-	-	-	-
700021538	CP 0548	80	-	658	806	-	931	980	1046	-	-	-	-	-
700021539	CP 0548	90	-	681	846	-	982	1039	1113	-	-	-	-	-
700021540	CP 0548	100	-	707	881	-	1028	1087	1160	-	-	-	-	-
700021541	CP 0548	120	-	750	944	-	1112	1166	1244	-	-	-	-	-

Tower units
Columnas
Colonnes

Tower unit with door
Módulo columna con puerta
Module colonne avec porte

H. 210

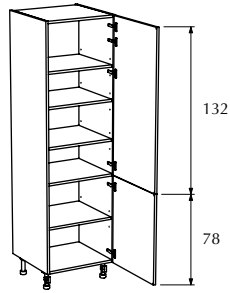

Tower unit with door.
2 doors.
1 fixed shelf.
4 shelves.

Módulo columna con puerta.
2 puertas.
1 balda fija.
4 baldas.

Module colonne avec porte.
2 portes.
1 étagère fixe.
4 étagères.

Availability / disponibilidad / disponibilité:

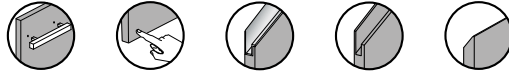

61 depth / profundidad / profondeur

SAP	Code Código Code	Width Ancho Largeur	Opening Apertura Ouverture											
				0	1	2	3	4	5	6	7	8	9	10
700021542	CP 0549	30	L / R	637	707	-	796	845	887	-	960	-	-	-
700021543	CP 0549	40	L / R	653	735	-	835	887	936	-	1023	-	-	-
700021544	CP 0549	45	L / R	664	751	-	857	908	962	-	1055	-	-	-
700021545	CP 0549	50	L / R	679	773	-	885	946	998	-	1101	-	-	-
700021546	CP 0549	60	L / R	721	824	-	949	1006	1073	-	1185	-	-	-

45 depth / profundidad / profondeur

SAP	Code Código Code	Width Ancho Largeur	Opening Apertura Ouverture											
				0	1	2	3	4	5	6	7	8	9	10
700021547	CP 0550	30	L / R	589	661	-	746	795	837	-	917	-	-	-
700021548	CP 0550	40	L / R	610	694	-	790	834	886	-	978	-	-	-
700021549	CP 0550	45	L / R	619	708	-	810	869	923	-	1017	-	-	-
700021550	CP 0550	50	L / R	632	729	-	836	896	958	-	1051	-	-	-
700021551	CP 0550	60	L / R	651	757	-	876	932	998	-	1110	-	-	-

35 depth / profundidad / profondeur

SAP	Code Código Code	Width Ancho Largeur	Opening Apertura Ouverture											
				0	1	2	3	4	5	6	7	8	9	10
700021552	CP 0551	30	L / R	548	621	-	702	752	794	-	873	-	-	-
700021553	CP 0551	40	L / R	574	660	-	753	797	849	-	939	-	-	-
700021554	CP 0551	45	L / R	582	672	-	771	814	867	-	967	-	-	-
700021555	CP 0551	50	L / R	593	692	-	796	855	916	-	1010	-	-	-
700021556	CP 0551	60	L / R	609	717	-	832	887	954	-	1066	-	-	-

H. 210

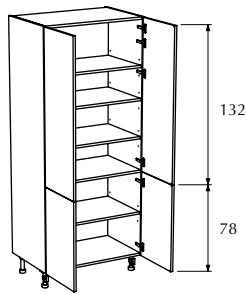

Tower unit with door.
4 doors.
1 fixed shelf.
4 shelves.

Módulo columna con puerta.
4 puertas.
1 balda fija.
4 baldas.

Module colonne avec porte.
4 portes.
1 étagère fixe.
4 étagères.

Availability / disponibilidad / disponibilité:

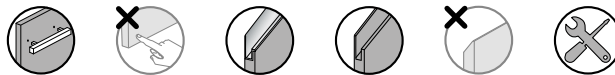

61 depth / profundidad / profondeur

SAP	Code Código Code	Width Ancho Largeur	Opening Apertura Ouverture											
				0	1	2	3	4	5	6	7	8	9	10
700021557	CP 0552	76,2	-	790	965	-	1116	1213	1300	-	1467	-	-	-
700021558	CP 0552	80	-	798	984	-	1140	1228	1320	-	1506	-	-	-
700021559	CP 0552	90	-	821	1016	-	1183	1293	1401	-	1569	-	-	-
700021560	CP 0552	100	-	850	1060	-	1240	1352	1474	-	1661	-	-	-
700021561	CP 0552	120	-	912	1142	-	1345	1449	1567	-	1806	-	-	-

45 depth / profundidad / profondeur

SAP	Code Código Code	Width Ancho Largeur	Opening Apertura Ouverture											
				0	1	2	3	4	5	6	7	8	9	10
700021562	CP 0553	76,2	-	723	902	-	1047	1144	1231	-	1396	-	-	-
700021563	CP 0553	80	-	741	929	-	1080	1178	1271	-	1445	-	-	-
700021564	CP 0553	90	-	760	958	-	1119	1216	1311	-	1504	-	-	-
700021565	CP 0553	100	-	785	998	-	1172	1271	1373	-	1592	-	-	-
700021566	CP 0553	120	-	823	1056	-	1251	1354	1460	-	1680	-	-	-

35 depth / profundidad / profondeur

SAP	Code Código Code	Width Ancho Largeur	Opening Apertura Ouverture											
				0	1	2	3	4	5	6	7	8	9	10
700021567	CP 0554	76,2	-	667	848	-	989	1086	1172	-	1337	-	-	-
700021568	CP 0554	80	-	674	865	-	1010	1107	1201	-	1373	-	-	-
700021569	CP 0554	90	-	697	897	-	1053	1149	1245	-	1437	-	-	-
700021570	CP 0554	100	-	722	938	-	1106	1205	1308	-	1525	-	-	-
700021571	CP 0554	120	-	765	1001	-	1191	1292	1399	-	1619	-	-	-

H. 210

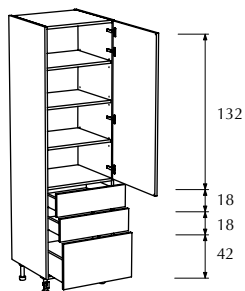

Tower unit with door.
1 door.
2 drawers.
1 deep drawer.
1 fixed shelf.
3 shelves.

Módulo columna con puerta.
1 puerta.
2 cajones.
1 gaveta.
1 balda fija.
3 baldas.

Module colonne avec porte.
1 porte.
2 tiroirs.
1 extractible.
1 étagère fixe.
3 étagères.

Availability / disponibilidad / disponibilité:

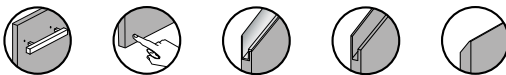

61 depth / profundidad / profondeur

SAP	Code Código Code	Width Ancho Largeur	Opening Apertura Ouverture											
				0	1	2	3	4	5	6	7	8	9	10
700021572	CCE 0555	30	L / R	1100	1204	-	1338	1429	1507	-	1621	-	-	-
700021573	CCE 0555	40	L / R	1123	1238	-	1384	1471	1553	-	1675	-	-	-
700021574	CCE 0555	45	L / R	1138	1258	-	1422	1496	1579	-	1725	-	-	-
700021575	CCE 0555	50	L / R	1157	1284	-	1455	1530	1619	-	1760	-	-	-
700021576	CCE 0555	60	L / R	1204	1343	-	1529	1618	1700	-	1861	-	-	-

45 depth / profundidad / profondeur

SAP	Code Código Code	Width Ancho Largeur	Opening Apertura Ouverture											
				0	1	2	3	4	5	6	7	8	9	10
700021577	CCE 0556	30	L / R	1073	1178	-	1322	1401	1478	-	1592	-	-	-
700021578	CCE 0556	40	L / R	1103	1218	-	1375	1450	1518	-	1635	-	-	-
700021579	CCE 0556	45	L / R	1116	1236	-	1399	1480	1556	-	1684	-	-	-
700021580	CCE 0556	50	L / R	1132	1261	-	1430	1519	1594	-	1717	-	-	-
700021581	CCE 0556	60	L / R	1158	1299	-	1480	1570	1652	-	1795	-	-	-

H. 210

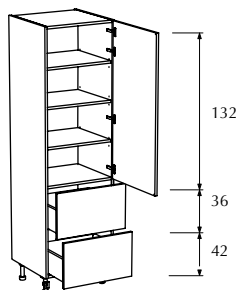

Tower unit with door.
1 door.
2 deep drawers.
1 fixed shelf.
3 shelves.

Módulo columna con puerta.
1 puerta.
2 gavetas.
1 balda fija.
3 baldas.

Module colonne avec porte.
1 porte.
2 extractibles.
1 étagère fixe.
3 étagères.

Availability / disponibilidad / disponibilité:

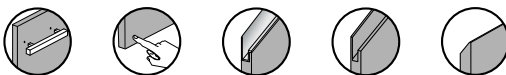

61 depth / profundidad / profondeur

SAP	Code Código Code	Width Ancho Largeur	Opening Apertura Ouverture											
				0	1	2	3	4	5	6	7	8	9	10
700021582	CE 0557	30	L / R	993	1076	-	1209	1297	1373	-	1482	-	-	-
700021583	CE 0557	40	L / R	1012	1105	-	1250	1335	1414	-	1530	-	-	-
700021584	CE 0557	45	L / R	1025	1123	-	1274	1357	1438	-	1563	-	-	-
700021585	CE 0557	50	L / R	1041	1147	-	1305	1396	1476	-	1612	-	-	-
700021586	CE 0557	60	L / R	1085	1199	-	1371	1460	1542	-	1683	-	-	-

45 depth / profundidad / profondeur

SAP	Code Código Code	Width Ancho Largeur	Opening Apertura Ouverture											
				0	1	2	3	4	5	6	7	8	9	10
700021587	CE 0558	30	L / R	961	1046	-	1176	1265	1341	-	1449	-	-	-
700021588	CE 0558	40	L / R	988	1082	-	1224	1309	1388	-	1503	-	-	-
700021589	CE 0558	45	L / R	999	1098	-	1246	1330	1410	-	1535	-	-	-
700021590	CE 0558	50	L / R	1013	1120	-	1275	1361	1446	-	1582	-	-	-
700021591	CE 0558	60	L / R	1035	1152	-	1318	1402	1490	-	1630	-	-	-

Tower units
Columnas
Colonnes

Tower corner unit
Módulo columna rinconero
Module colonne encoignure

H. 210

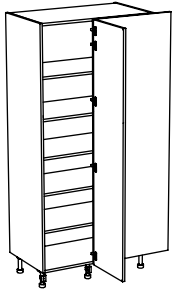

Tower straight corner unit.
1 door.
1 fixed shelf.
4 shelves.
Unit for standard corner filler, 10x10 cm.
Order corner filler separately to insert between add-on units for 90° union.

Módulo columna rinconero recto.
1 puerta.
1 balda fija.
4 baldas.
Módulo para regletas de unión estándar, 10x10 cm.
Solicitar regleta de unión por separado.

Modules colonne encoignure droite.
1 porte.
1 étagère fixe.
4 étagères.
Module pour fileur d'encoignure standard, 10x10 cm.
Commander fileur d'union séparément.

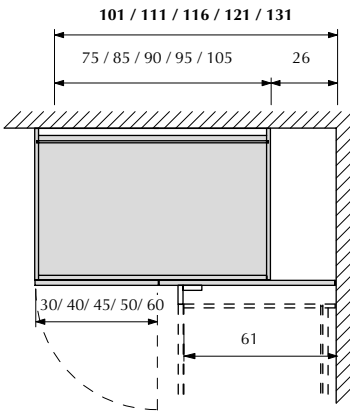

Availability / disponibilidad / disponibilité:

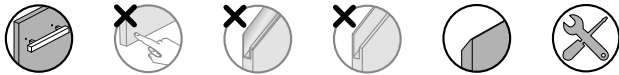

61 depth / profundidad / profondeur

SAP	Code Código Code	Width Ancho Largeur	Opening Apertura Ouverture	0	1	2	3	4	5	6	7	8	9	10
700021592	CRR 0559	101	L / R	767	937	-	1089	1138	1190	-	-	-	-	-
700021593	CRR 0559	111	L / R	789	970	-	1132	1182	1234	-	-	-	-	-
700021594	CRR 0559	116	L / R	801	989	-	1157	1212	1269	-	-	-	-	-
700021595	CRR 0559	121	L / R	812	1006	-	1179	1234	1292	-	-	-	-	-
700021596	CRR 0559	131	L / R	841	1044	-	1228	1284	1343	-	-	-	-	-

H. 210

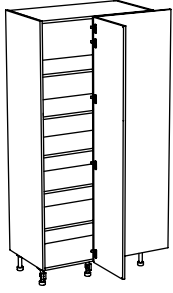

Tower straight corner unit.
1 door.
1 fixed shelf.
4 shelves.
Unit for corner filler with raised door profile 4x4 cm.
Order corner filler separately to insert between add-on units for 90° union.

Módulo columna rinconero recto.
1 puerta.
1 balda fija.
4 baldas.
Módulo para regleta de rincón con perfil de puerta de 4x4 cm.
Solicitar regleta de unión por separado.

Modules colonne encoignure droite.
1 porte.
1 étagère fixe.
4 étagères.
Module pour fileur d'encoignure avec profilé de porte, 4x4 cm.
Commander fileur d'union séparément.

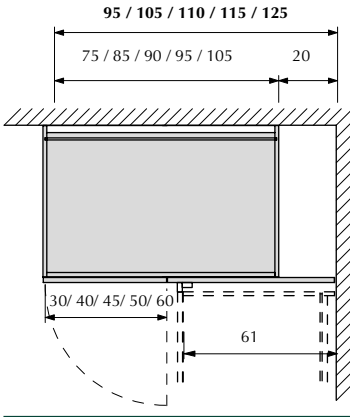

Availability / disponibilidad / disponibilité:

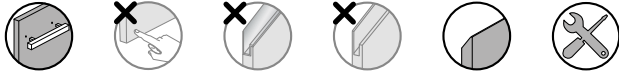

61 depth / profundidad / profondeur

SAP	Code Código Code	Width Ancho Largeur	Opening Apertura Ouverture	0	1	2	3	4	5	6	7	8	9	10
700022030	CRR 0559	95	L / R	767	937	-	1089	1138	1190	-	-	-	-	-
700022031	CRR 0559	105	L / R	789	970	-	1132	1182	1234	-	-	-	-	-
700022032	CRR 0559	110	L / R	801	989	-	1157	1212	1269	-	-	-	-	-
700022033	CRR 0559	115	L / R	812	1006	-	1179	1234	1292	-	-	-	-	-
700022034	CRR 0559	125	L / R	841	1044	-	1228	1284	1343	-	-	-	-	-

H. 210

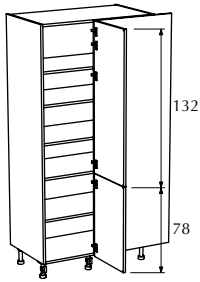

Tower straight corner unit.
2 doors.
1 fixed shelf.
4 shelves.
Unit for standard corner filler, 10x10 cm.
Order corner filler separately to insert between add-on units for 90° union.

Módulo columna rinconero recto.
2 puertas.
1 balda fija.
4 baldas.
Módulo para regletas de unión estándar, 10x10 cm.
Solicitar regleta de unión por separado.

Modules colonne encoignure droite.
2 portes.
1 étagère fixe.
4 étagères.
Module pour fileur d'encoignure standard, 10x10 cm.
Commander fileur d'union séparément.

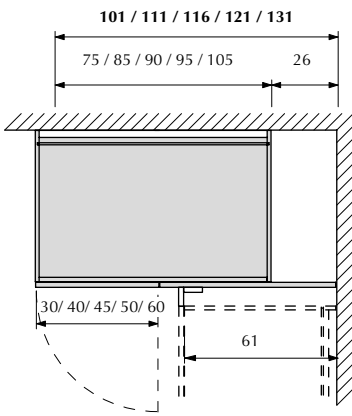

Availability / disponibilidad / disponibilité:

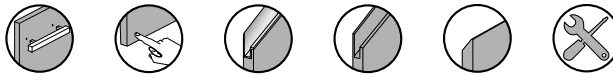

61 depth / profundidad / profondeur

SAP	Code Código Code	Width Ancho Largeur	Opening Apertura Ouverture											
				0	1	2	3	4	5	6	7	8	9	10
700021597	CRR 0560	101	L / R	777	973	-	1127	1178	1241	-	1404	-	-	-
700021598	CRR 0560	111	L / R	799	1009	-	1174	1222	1293	-	1474	-	-	-
700021599	CRR 0560	116	L / R	811	1025	-	1196	1241	1316	-	1505	-	-	-
700021600	CRR 0560	121	L / R	822	1045	-	1221	1270	1349	-	1547	-	-	-
700021601	CRR 0560	131	L / R	851	1083	-	1270	1314	1400	-	1615	-	-	-

H. 210

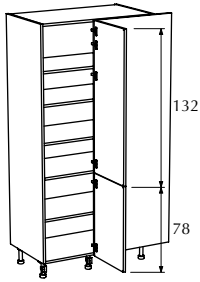

Tower straight corner unit.
2 doors.
1 fixed shelf.
4 shelves.
Unit for corner filler with raised door profile 4x4 cm.
Order corner filler separately to insert between add-on units for 90° union.

Módulo columna rinconero recto.
2 puertas.
1 balda fija.
4 baldas.
Módulo para regleta de rincón con perfil de puerta de 4x4 cm.
Solicitar regleta de unión por separado.

Modules colonne encoignure droite.
2 portes.
1 étagère fixe.
4 étagères.
Module pour fileur d'encoignure avec profilé de porte, 4x4 cm.
Commander fileur d'union séparément.

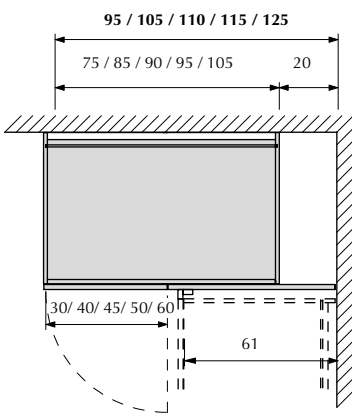

Availability / disponibilidad / disponibilité:

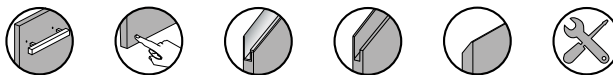

61 depth / profundidad / profondeur

SAP	Code Código Code	Width Ancho Largeur	Opening Apertura Ouverture											
				0	1	2	3	4	5	6	7	8	9	10
700022035	CRR 0560	95	L / R	777	973	-	1127	1178	1241	-	1404	-	-	-
700022036	CRR 0560	105	L / R	799	1009	-	1174	1222	1293	-	1474	-	-	-
700022037	CRR 0560	110	L / R	811	1025	-	1196	1241	1316	-	1505	-	-	-
700022038	CRR 0560	115	L / R	822	1045	-	1221	1270	1349	-	1547	-	-	-
700022039	CRR 0560	125	L / R	851	1083	-	1270	1314	1400	-	1615	-	-	-

H. 210

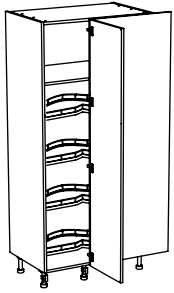

Tower straight corner unit.
1 door.
1 shelf.
4 Rotating drawers shelves.
Unit for standard corner filler, 10x10 cm.
Order corner filler separately to insert between add-on units for 90° union.

Módulo columna rinconero recto.
1 puerta.
1 balda.
4 Baldas giratorias y extraíbles.
Módulo para regletas de unión estándar, 10x10 cm.
Solicitar regleta de unión por separado.

Modules colonne encoignure droite.
1 porte.
1 étagère.
4 Étagères pivotantes extractibles.
Module pour fileur d'encoignure standard, 10x10 cm.
Commander fileur d'union séparément.

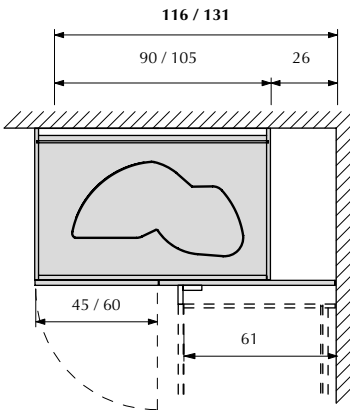

Availability / disponibilidad / disponibilité:

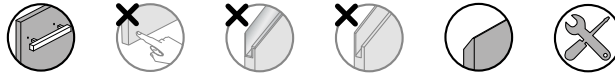

61 depth / profundidad / profondeur

SAP	Code Código Code	Width Ancho Largeur	Opening Apertura Ouverture											
				0	1	2	3	4	5	6	7	8	9	10
700021602	CRR 0561	116	L / R	2487	2633	-	2920	3008	3099	-	-	-	-	-
700021604	CRR 0561	131	L / R	2708	2864	-	3181	3273	3369	-	-	-	-	-

H. 210

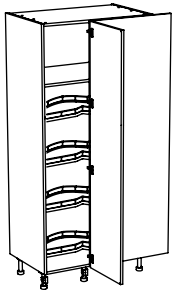

Tower straight corner unit.
1 door.
1 shelf.
4 Rotating drawers shelves.
Unit for corner filler with raised door profile 4x4 cm.
Order corner filler separately to insert between add-on units for 90° union.

Módulo columna rinconero recto.
1 puerta.
1 balda.
4 Baldas giratorias y extraíbles.
Módulo para regleta de rincón con perfil de puerta de 4x4 cm.
Solicitar regleta de unión por separado.

Modules colonne encoignure droite.
1 porte.
1 étagère.
4 Étagères pivotantes extractibles.
Module pour fileur d'encoignure avec profilé de porte, 4x4 cm.
Commander fileur d'union séparément.

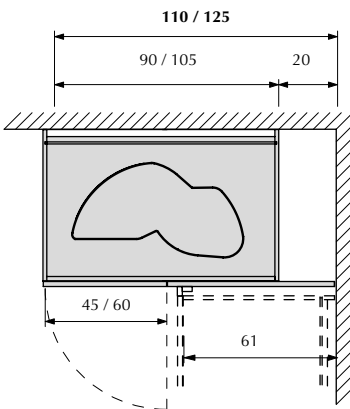

Availability / disponibilidad / disponibilité:

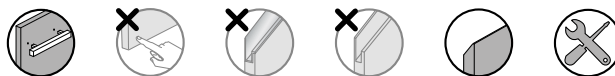

61 depth / profundidad / profondeur

SAP	Code Código Code	Width Ancho Largeur	Opening Apertura Ouverture											
				0	1	2	3	4	5	6	7	8	9	10
700022040	CRR 0561	110	L / R	2487	2633	-	2920	3008	3099	-	-	-	-	-
700022042	CRR 0561	125	L / R	2708	2864	-	3181	3273	3369	-	-	-	-	-

H. 210

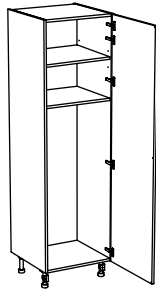

Tower broom and cleaning product unit.
1 door.
1 fixed shelf.
1 shelf.

Módulo columna para útiles de limpieza.
1 puerta.
1 balda fija.
1 balda.

Colonne pour utensiles de nettoyage.
1 porte.
1 étagère fixe.
1 étagère

Availability / disponibilidad / disponibilité:

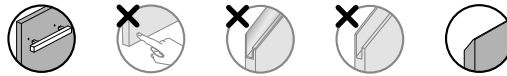

61 depth / profundidad / profondeur

SAP	Code Código Code	Width Ancho Largeur	Opening Apertura Ouverture											
				0	1	2	3	4	5	6	7	8	9	10
700021605	CUL 0562	30	L / R	537	595	-	663	695	720	-	-	-	-	-
700021606	CUL 0562	40	L / R	545	614	-	692	722	749	-	-	-	-	-
700021607	CUL 0562	45	L / R	553	630	-	713	741	779	-	-	-	-	-
700021608	CUL 0562	50	L / R	564	646	-	734	765	800	-	-	-	-	-
700021609	CUL 0562	60	L / R	591	683	-	782	813	848	-	-	-	-	-

45 depth / profundidad / profondeur

SAP	Code Código Code	Width Ancho Largeur	Opening Apertura Ouverture											
				0	1	2	3	4	5	6	7	8	9	10
700021610	CUL 0563	30	L / R	494	554	-	619	651	676	-	-	-	-	-
700021611	CUL 0563	40	L / R	509	579	-	654	678	711	-	-	-	-	-
700021612	CUL 0563	45	L / R	516	594	-	674	702	740	-	-	-	-	-
700021613	CUL 0563	50	L / R	525	608	-	694	725	760	-	-	-	-	-
700021614	CUL 0563	60	L / R	539	631	-	727	757	793	-	-	-	-	-

35 depth / profundidad / profondeur

SAP	Code Código Code	Width Ancho Largeur	Opening Apertura Ouverture											
				0	1	2	3	4	5	6	7	8	9	10
700021615	CUL 0564	30	L / R	459	520	-	583	615	640	-	-	-	-	-
700021616	CUL 0564	40	L / R	478	548	-	621	646	679	-	-	-	-	-
700021617	CUL 0564	45	L / R	484	563	-	641	669	706	-	-	-	-	-
700021618	CUL 0564	50	L / R	493	577	-	660	684	726	-	-	-	-	-
700021619	CUL 0564	60	L / R	505	598	-	691	721	757	-	-	-	-	-

H. 210

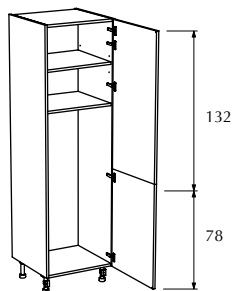

Tower broom and cleaning product unit.
2 doors.
1 fixed shelf.
1 shelf.

Módulo columna para útiles de limpieza.
2 puertas.
1 balda fija.
1 balda.

Colonne pour utensiles de nettoyage.
2 portes.
1 étagère fixe.
1 étagère

Availability / disponibilidad / disponibilité:

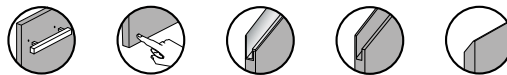

61 depth / profundidad / profondeur

SAP	Code Código Code	Width Ancho Largeur	Opening Apertura Ouverture											
				0	1	2	3	4	5	6	7	8	9	10
700021620	CUL 0565	30	L / R	552	625	-	713	756	798	-	869	-	-	-
700021621	CUL 0565	40	L / R	561	647	-	739	797	842	-	925	-	-	-
700021622	CUL 0565	45	L / R	568	659	-	756	814	860	-	953	-	-	-
700021623	CUL 0565	50	L / R	579	678	-	781	840	893	-	995	-	-	-
700021624	CUL 0565	60	L / R	607	715	-	830	885	942	-	1063	-	-	-

45 depth / profundidad / profondeur

SAP	Code Código Code	Width Ancho Largeur	Opening Apertura Ouverture											
				0	1	2	3	4	5	6	7	8	9	10
700021625	CUL 0566	30	L / R	509	584	-	662	718	760	-	831	-	-	-
700021626	CUL 0566	40	L / R	524	612	-	701	745	797	-	886	-	-	-
700021627	CUL 0566	45	L / R	531	624	-	718	775	829	-	913	-	-	-
700021628	CUL 0566	50	L / R	541	641	-	741	799	853	-	954	-	-	-
700021629	CUL 0566	60	L / R	554	664	-	774	828	895	-	1007	-	-	-

35 depth / profundidad / profondeur

SAP	Code Código Code	Width Ancho Largeur	Opening Apertura Ouverture											
				0	1	2	3	4	5	6	7	8	9	10
700021630	CUL 0567	30	L / R	475	551	-	626	675	717	-	787	-	-	-
700021631	CUL 0567	40	L / R	493	582	-	668	712	764	-	853	-	-	-
700021632	CUL 0567	45	L / R	499	593	-	684	741	795	-	879	-	-	-
700021633	CUL 0567	50	L / R	508	610	-	707	765	826	-	919	-	-	-
700021634	CUL 0567	60	L / R	520	632	-	739	792	859	-	971	-	-	-

Tower units
Columnas
Colonnes

Tower unit with interior equipment
Módulo columna con equipamiento interior
Module colonne avec équipement intérieur

H. 210

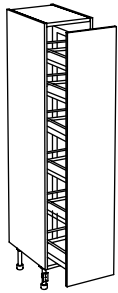

Tower pull-out larder unit.
1 door.
1 pull-out unit with 6 basket with non-slip base and metal structure.

Columna provisiones extraíble.
1 puerta.
1 armazón extraíble con 6 cestas con base antideslizante y estructura metálica.

Colonne bac à provisions extractible
1 porte.
1 structure extractible avec 6 paniers avec base anti-dérapant et structure métallique.

Availability / disponibilidad / disponibilité:



61 depth / profundidad / profondeur														
SAP	Code Código Code	Width Ancho Largeur	Opening Apertura Ouverture	0	1	2	3	4	5	6	7	8	9	10
700021635	CEQ 0568	30	-	2108	2127	-	2306	2391	2461	-	-	-	-	-

H. 210

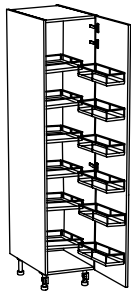

Tower larder unit Tandem.
1 door.
1 fixed structure with 6 baskets with non-slip base and metal structure on door.
1 pull-out unit with 6 baskets with non-slip base and metal structure.

Columna provisiones Tandem.
1 puerta.
1 armazón fijo con 6 cestas con base antideslizante y estructura metálica en la puerta.
1 armazón extraíble con 6 cestas con base antiadherente y estructura metálica.

Colonne bac à provisions Tandem.
1 porte.
1 structure fixe avec 6 paniers avec base anti-dérapant et structure métallique sur la porte.
1 structure extractible avec 6 paniers avec base anti-dérapant et structure métallique.

Availability / disponibilidad / disponibilité:



61 depth / profundidad / profondeur														
SAP	Code Código Code	Width Ancho Largeur	Opening Apertura Ouverture	0	1	2	3	4	5	6	7	8	9	10
700021636	CEQ 0569	45	-	2682	2705	-	2939	3023	3118	-	-	-	-	-
700021637	CEQ 0569	60	-	2890	2923	-	3185	3261	3374	-	-	-	-	-

H. 210

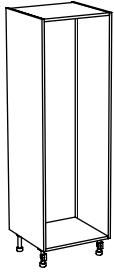

Carcass for tower unit kit for oven and microwave.

Comments:
Must be filled with units for oven and microwave tower unit kit.
See instructions on chapter 01.

Casco para kit columna de horno y microondas.

Observaciones:
Se debe completar con módulos para kit columna horno y microondas.
Ver instrucciones en capítulos 01.

Caisson pour kit colonne pour four et micro-ondes.

Remarques:
Doit être complétés avec les modules pour kit colonne four et micro-ondes.
Voir instructions en chapitre 01.

Availability / disponibilidad / disponibilité:



61 depth / profundidad / profondeur				
SAP	Code Código Code	Width Ancho Largeur	Opening Apertura Ouverture	Carcass colour Color de casco Couleur de caisson
700021900	CHM 0626	60	-	411
700021901	CHM 0626	68,6	-	416
700021902	CHM 0626	76,2	-	419
700021903	CHM 0626	90	-	427
700021904	CHM 0626	91,5	-	428

H. 210

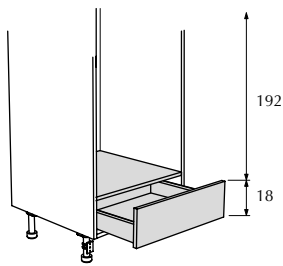

Lower unit with drawers for kit for oven and microwave.
1 drawer.
1 top shelf.
1 back panel.
H 18

Módulo inferior con cajones para kit columna de horno y microondas.
1 cajón.
1 techo.
1 trasera.
H 18

Module inférieur avec tiroirs pour four et micro-ondes.
1 tiroir.
1 joue supérieure.
1 panneau arrière.
H 18

Availability / disponibilidad / disponibilité:

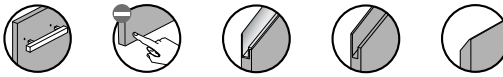

61 depth / profundidad / profondeur														
SAP	Code Código Code	Width Ancho Largeur	Opening Apertura Ouverture	0	1	2	3	4	5	6	7	8	9	10
700021915	CHM 0629	60	-	285	308	-	353	376	387	-	407	-	-	-
700021916	CHM 0629	68,6	-	295	318	-	365	391	402	-	421	-	-	-
700021917	CHM 0629	76,2	-	303	327	-	376	403	413	-	433	-	-	-
700021918	CHM 0629	90	-	312	338	-	389	415	426	-	448	-	-	-
700021919	CHM 0629	91,5	-	313	339	-	390	418	431	-	450	-	-	-

H. 210

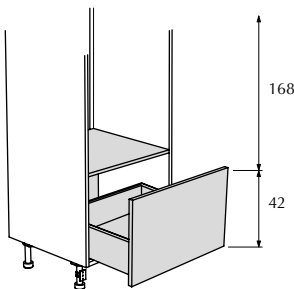

Lower unit with drawers for kit for oven and microwave.
1 deep drawer.
1 top shelf.
1 back panel.
H 42

Módulo inferior con cajones para kit columna de horno y microondas.
1 gaveta.
1 techo.
1 trasera.
H 42

Module inférieur avec tiroirs pour four et micro-ondes.
1 extractible.
1 joue supérieure.
1 panneau arrière.
H 42

Availability / disponibilidad / disponibilité:

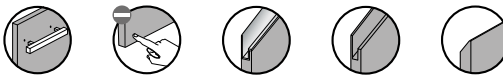

61 depth / profundidad / profondeur														
SAP	Code Código Code	Width Ancho Largeur	Opening Apertura Ouverture	0	1	2	3	4	5	6	7	8	9	10
700021920	CHM 0630	60	-	332	361	-	407	435	455	-	486	-	-	-
700021921	CHM 0630	68,6	-	342	372	-	421	450	469	-	504	-	-	-
700021922	CHM 0630	76,2	-	353	388	-	440	470	492	-	530	-	-	-
700021923	CHM 0630	90	-	363	400	-	455	484	504	-	542	-	-	-
700021924	CHM 0630	91,5	-	364	401	-	457	488	508	-	544	-	-	-

H. 210

Lower unit with door for kit for oven and microwave.
1 door.
1 shelf.
1 top shelf.
1 back panel.
H 60

Módulo inferior con puerta para kit columna de horno y microondas.
1 puerta.
1 balda.
1 techo.
1 trasera.
H 60

Module inférieur avec porte pour four et micro-ondes.
1 porte.
1 étagère.
1 joue supérieure.
1 panneau arrière.
H 60

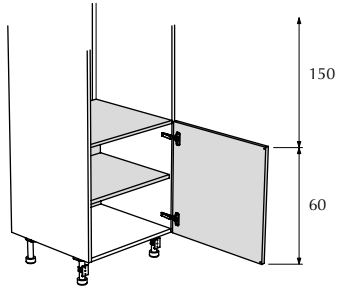

Availability / disponibilidad / disponibilité:

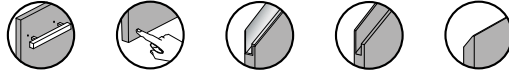

61 depth / profundidad / profondeur

SAP	Code Código Code	Width Ancho Largeur	Opening Apertura Ouverture											
				0	1	2	3	4	5	6	7	8	9	10
700021925	CHM 0631	60	-	172	216	-	257	278	297	-	329	-	-	-
700021926	CHM 0631	68,6	-	178	224	-	268	291	314	-	351	-	-	-
700021927	CHM 0631	76,2	-	183	231	-	273	301	324	-	358	-	-	-

H. 210

Lower unit with drawers for kit for oven and microwave.
1 deep drawer.
1 top shelf.
1 back panel.
H 60

Módulo inferior con cajones para kit columna de horno y microondas.
1 gaveta.
1 techo.
1 trasera.
H 60

Module inférieur avec tiroirs pour four et micro-ondes.
1 extractible.
1 joue supérieure.
1 panneau arrière.
H 60

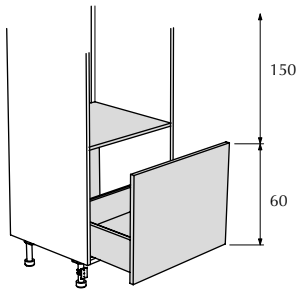

Availability / disponibilidad / disponibilité:

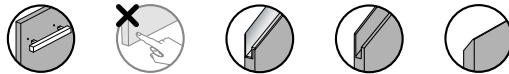

61 depth / profundidad / profondeur

SAP	Code Código Code	Width Ancho Largeur	Opening Apertura Ouverture											
				0	1	2	3	4	5	6	7	8	9	10
700021928	CHM 0632	60	-	338	375	-	423	452	475	-	511	-	-	-
700021929	CHM 0632	68,6	-	348	388	-	439	469	491	-	527	-	-	-
700021930	CHM 0632	76,2	-	357	398	-	453	483	505	-	545	-	-	-
700021931	CHM 0632	90	-	367	412	-	471	507	529	-	566	-	-	-
700021932	CHM 0632	91,5	-	368	414	-	473	509	531	-	569	-	-	-

H. 210

Lower unit with drawers for kit for oven and microwave.
1 drawer.
1 deep drawer.
1 top shelf.
1 back panel.
H 60

Módulo inferior con cajones para kit columna de horno y microondas.
1 cajón.
1 gaveta.
1 techo.
1 trasera.
H 60

Module inférieur avec tiroirs pour four et micro-ondes.
1 tiroir.
1 extractible.
1 joue supérieure.
1 panneau arrière.
H 60

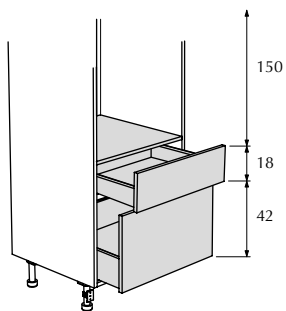

Availability / disponibilidad / disponibilité:



61 depth / profundidad / profondeur

SAP	Code Código Code	Width Ancho Largeur	Opening Apertura Ouverture											
				0	1	2	3	4	5	6	7	8	9	10
700021933	CHM 0633	60	-	504	560	-	637	692	725	-	771	-	-	-
700021934	CHM 0633	68,6	-	521	579	-	660	721	748	-	792	-	-	-
700021935	CHM 0633	76,2	-	536	599	-	691	746	776	-	817	-	-	-
700021936	CHM 0633	90	-	551	618	-	702	768	801	-	850	-	-	-
700021937	CHM 0633	91,5	-	552	620	-	705	770	804	-	853	-	-	-

H. 210

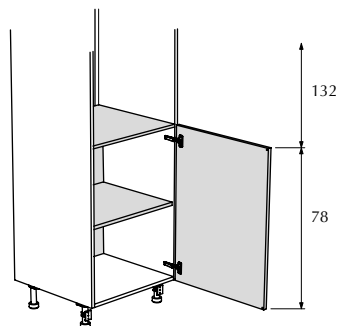

Lower unit with door for kit for oven and microwave.
1 door.
1 shelf.
1 top shelf.
1 back panel.

H 78

Módulo inferior con puerta para kit columna de horno y microondas.
1 puerta.
1 balda.
1 techo.
1 trasera.

H 78

Module inférieur avec porte pour four et micro-ondes.
1 porte.
1 étagère.
1 joue supérieure.
1 panneau arrière.

H 78

Availability / disponibilidad / disponibilité:

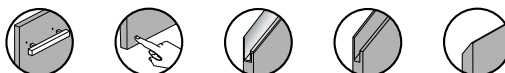

61 depth / profundidad / profondeur

SAP	Code Código Code	Width Ancho Largeur	Opening Apertura Ouverture											
				0	1	2	3	4	5	6	7	8	9	10
700021938	CHM 0634	60	-	175	225	-	263	288	311	-	352	-	-	-
700021939	CHM 0634	68,6	-	181	234	-	276	301	327	-	371	-	-	-
700021940	CHM 0634	76,2	-	187	242	-	287	312	339	-	388	-	-	-

H. 210

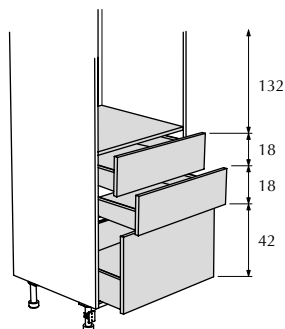

Lower unit with drawers for kit for oven and microwave.
2 drawers.
1 deep drawer.
1 top shelf.
1 back panel.

H 78

Módulo inferior con cajones para kit columna de horno y microondas.
2 cajones.
1 gaveta.
1 techo.
1 trasera.

H 78

Module inférieur avec tiroirs pour four et micro-ondes.
2 tiroirs.
1 extractible.
1 joue supérieure.
1 panneau arrière.

H 78

Availability / disponibilidad / disponibilité:

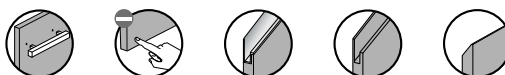

61 depth / profundidad / profondeur

SAP	Code Código Code	Width Ancho Largeur	Opening Apertura Ouverture											
				0	1	2	3	4	5	6	7	8	9	10
700021941	CHM 0635	60	-	674	758	-	853	931	974	-	1043	-	-	-
700021942	CHM 0635	68,6	-	697	784	-	884	971	1024	-	1092	-	-	-
700021943	CHM 0635	76,2	-	718	811	-	916	1005	1051	-	1124	-	-	-
700021944	CHM 0635	90	-	740	839	-	951	1036	1077	-	1159	-	-	-
700021945	CHM 0635	91,5	-	743	841	-	955	1046	1100	-	1186	-	-	-

H. 210

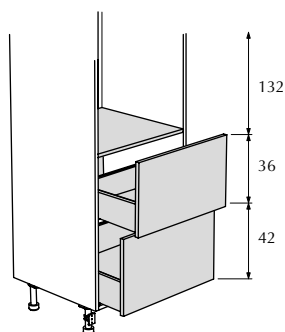

Lower unit with drawers for kit for oven and microwave.
2 deep drawers.
1 top shelf.
1 back panel.

H 78

Módulo inferior con cajones para kit columna de horno y microondas.
2 gavetas.
1 techo.
1 trasera.

H 78

Module inférieur avec tiroirs pour four et micro-ondes.
2 extractibles.
1 joue supérieure.
1 panneau arrière.

H 78

Availability / disponibilidad / disponibilité:

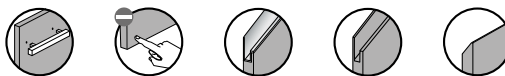

61 depth / profundidad / profondeur

SAP	Code Código Code	Width Ancho Largeur	Opening Apertura Ouverture											
				0	1	2	3	4	5	6	7	8	9	10
700021946	CHM 0636	60	-	550	610	-	690	764	826	-	901	-	-	-
700021947	CHM 0636	68,6	-	567	630	-	735	800	852	-	934	-	-	-
700021948	CHM 0636	76,2	-	582	651	-	761	824	874	-	952	-	-	-
700021949	CHM 0636	90	-	599	676	-	794	855	906	-	1004	-	-	-
700021950	CHM 0636	91,5	-	601	678	-	797	864	917	-	1008	-	-	-

H. 210

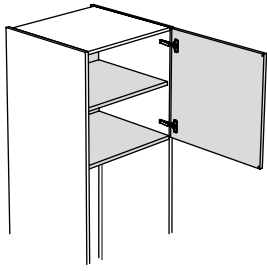

Upper unit with door for kit for oven and microwave.
1 door.
1 Shelf.
1 base shelf.
1 back panel.
Variable height.
Minimum height, 30 cm.

Módulo superior con puerta para kit columna de horno y microondas.
1 puerta.
1 balda.
1 base.
1 trasera.
Altura variable.
Altura mínima, 30 cm.

Modules supérieur avec porte pour four et micro-ondes.
1 porte.
1 étagère.
1 joue inférieure.
1 panneau arrière.
Hauteur variable.
Hauteur minimale de 30 cm.

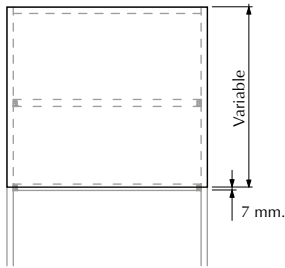

Availability / disponibilidad / disponibilité:

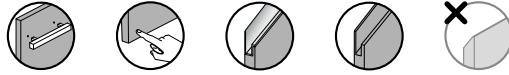

61 depth / profundidad / profondeur

SAP	Code Código Code	Width Ancho Largeur	Opening Apertura Ouverture											
				0	1	2	3	4	5	6	7	8	9	10
700021951	CHM 0637	60	-	177	230	-	273	300	327	-	368	-	-	-
700021952	CHM 0637	68,6	-	184	244	-	290	320	352	-	400	-	-	-
700021953	CHM 0637	76,2	-	191	254	-	304	335	367	-	420	-	-	-

H. 210

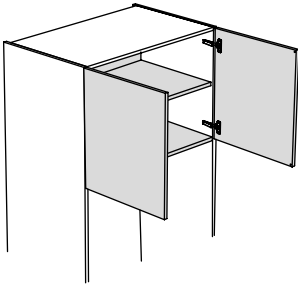

Upper unit with door for kit for oven and microwave.
2 doors.
1 Shelf.
1 base shelf.
1 back panel.
Variable height.
Minimum height, 30 cm.

Módulo superior con puerta para kit columna de horno y microondas.
2 puertas.
1 balda.
1 base.
1 trasera.
Altura variable.
Altura mínima, 30 cm.

Modules supérieur avec porte pour four et micro-ondes.
2 portes.
1 étagère.
1 joue inférieure.
1 panneau arrière.
Hauteur variable.
Hauteur minimale de 30 cm.

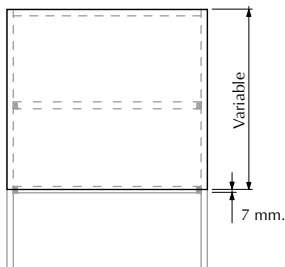

Availability / disponibilidad / disponibilité:

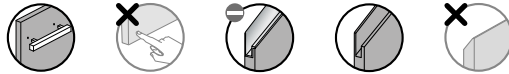

61 depth / profundidad / profondeur

SAP	Code Código Code	Width Ancho Largeur	Opening Apertura Ouverture											
				0	1	2	3	4	5	6	7	8	9	10
700021954	CHM 0638	76,2	-	207	299	-	367	409	457	-	518	-	-	-
700021955	CHM 0638	90	-	217	315	-	379	425	476	-	542	-	-	-
700021956	CHM 0638	91,5	-	218	325	-	397	450	498	-	576	-	-	-

H. 210

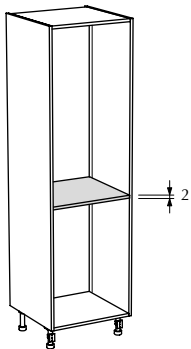

Shelf for kit for oven and microwave.
1 shelf.
H 2

Balda para kit columna de horno y microondas.
1 balda.
H 2

Étagère pour four et micro-ondes.
1 étagère.
H 2

61 depth / profundidad / profondeur

SAP	Code Código Code	Width Ancho Largeur	Opening Apertura Ouverture	Carcass colour
				Color de casco Couleur de caisson
700021957	CHM 0639	60	-	66
700021958	CHM 0639	68,6	-	69
700021959	CHM 0639	76,2	-	71
700021960	CHM 0639	90	-	74
700021961	CHM 0639	91,5	-	74

Tower units
Columnas
Colonnes

Tower unit for fridge
Módulo columna para frigorífico
Module colonne pour réfrigérateur

H. 210

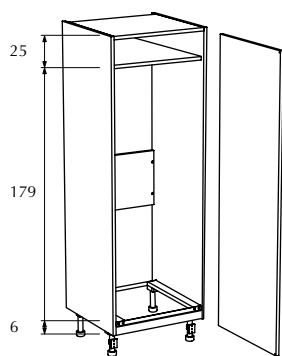

Tower unit for fridge.
1 door.
1 structure with ventilation grille.
1 shelf.
1 back panel.
WITHOUT hinges.

Columna de frigorífico.
1 puerta.
1 estructura con rejilla de ventilación.
1 balda.
1 trasera.
SIN bisagras.

Colonne réfrigérateur.
1 porte.
1 structure avec grille d'aération.
1 étagère.
1 panneau arrière.
SANS charnières.

Availability / disponibilidad / disponibilité:



61 depth / profundidad / profondeur

SAP	Code Código Code	Width Ancho Largeur	Opening Apertura Ouverture											
				0	1	2	3	4	5	6	7	8	9	10
700021970	CFS 0649	60	-	624	715	-	816	848	882	-	-	-	-	-

H. 210

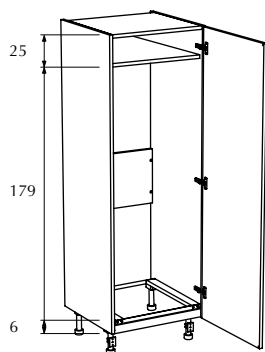

Tower unit for fridge.
1 door.
1 structure with ventilation grille.
1 shelf.
1 back panel.
WITH hinges.

Columna de frigorífico.
1 puerta.
1 estructura con rejilla de ventilación.
1 balda.
1 trasera.
CON bisagras.

Colonne réfrigérateur.
1 porte.
1 structure avec grille d'aération.
1 étagère.
1 panneau arrière.
AVEC charnières.

Availability / disponibilidad / disponibilité:



61 depth / profundidad / profondeur

SAP	Code Código Code	Width Ancho Largeur	Opening Apertura Ouverture											
				0	1	2	3	4	5	6	7	8	9	10
700021971	CF 0650	60	-	624	715	-	816	848	882	-	-	-	-	-

Tower units
Columnas
Colonnes

Tower unit for fridge
Módulo columna para frigorífico
Module colonne pour réfrigérateur

H. 210

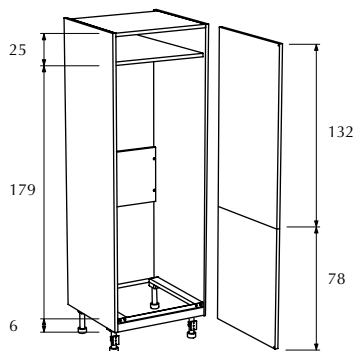

Tower unit for fridge.
2 doors.
1 structure with ventilation grille.
1 shelf.
1 back panel.
WITHOUT hinges.

Columna de frigorífico.
2 puertas.
1 estructura con rejilla de ventilación.
1 balda.
1 trasera.
SIN bisagras.

Colonne réfrigérateur.
2 portes.
1 structure avec grille d'aération.
1 étagère.
1 panneau arrière.
SANS charnières.

Availability / disponibilidad / disponibilité:

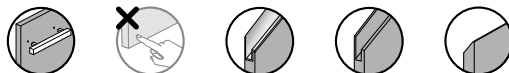

61 depth / profundidad / profondeur

SAP	Code Código Code	Width Ancho Largeur	Opening Apertura Ouverture	0	1	2	3	4	5	6	7	8	9	10
				700021972	CFS 0651	60	-	639	746	-	864	920	986	-

H. 210

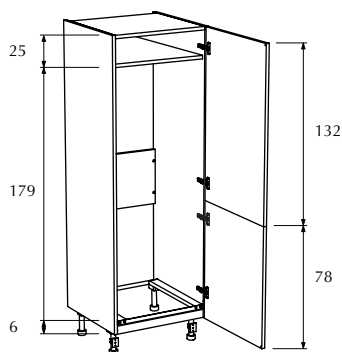

Tower unit for fridge.
2 doors.
1 structure with ventilation grille.
1 shelf.
1 back panel.
WITH hinges.

Columna de frigorífico.
2 puertas.
1 estructura con rejilla de ventilación.
1 balda.
1 trasera.
CON bisagras.

Colonne réfrigérateur.
2 portes.
1 structure avec grille d'aération.
1 étagère.
1 panneau arrière.
AVEC charnières.

Availability / disponibilidad / disponibilité:

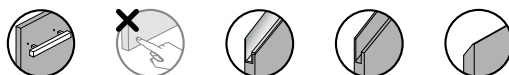

61 depth / profundidad / profondeur

SAP	Code Código Code	Width Ancho Largeur	Opening Apertura Ouverture	0	1	2	3	4	5	6	7	8	9	10
				700021973	CF 0652	60	L / R	639	746	-	864	920	986	-

Tower units
Columnas
Colonnes

Tower unit for fridge
Módulo columna para frigorífico
Module colonne pour réfrigérateur

H. 210

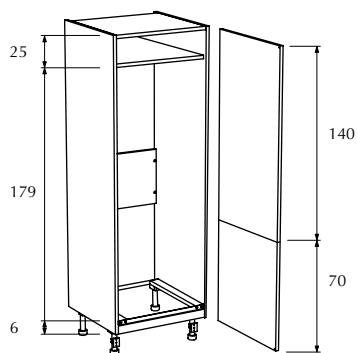

Tower unit for fridge.
2 doors.
1 structure with ventilation grille.
1 shelf.
1 back panel.
WITHOUT hinges.

Columna de frigorífico.
2 puertas.
1 estructura con rejilla de ventilación.
1 balda.
1 trasera.
SIN bisagras.

Colonne réfrigérateur.
2 portes.
1 structure avec grille d'aération.
1 étagère.
1 panneau arrière.
SANS charnières.

Availability / disponibilidad / disponibilité:

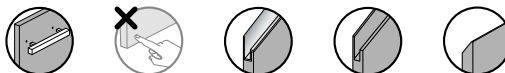

61 depth / profundidad / profondeur

SAP	Code Código Code	Width Ancho Largeur	Opening Apertura Ouverture	0	1	2	3	4	5	6	7	8	9	10
				700021974	CFS 0653	60	-	639	746	-	864	920	986	-

H. 210

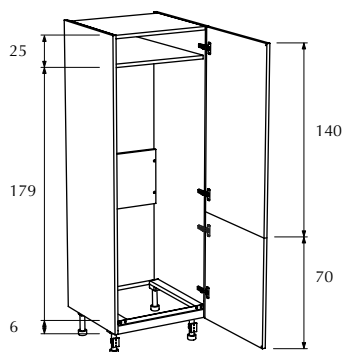

Tower unit for fridge.
2 doors.
1 structure with ventilation grille.
1 shelf.
1 back panel.
WITH hinges.

Columna de frigorífico.
2 puertas.
1 estructura con rejilla de ventilación.
1 balda.
1 trasera.
CON bisagras.

Colonne réfrigérateur.
2 portes.
1 structure avec grille d'aération.
1 étagère.
1 panneau arrière.
AVEC charnières.

Availability / disponibilidad / disponibilité:

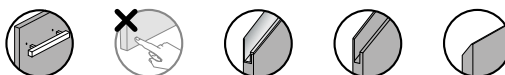

















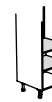



61 depth / profundidad / profondeur

SAP	Code Código Code	Width Ancho Largeur	Opening Apertura Ouverture	0	1	2	3	4	5	6	7	8	9	10
				700021975	CF 0654	60	L / R	639	746	-	864	920	986	-

h. 222

Tower units
Columnas
Colonnes

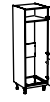
Type of unit Tipo de módulo Type de module	Available measures Medidas disponibles Dimensions disponibles	Available units Módulos disponibles Modules disponibles
<p>p.142</p> <p>Tower unit with door Columna con puerta Colonne avec porte</p>	<p>Depth / Profundidad / Profondeur (cm.): 35 - 45 - 61</p> <p>Width / Ancho / Largeur (cm.): 30 - 40 - 45 - 50 - 60 (1 door) 76,2 - 80 - 90 - 100 - 120 (2 doors)</p>	 CP 0576 - 0577 - 0578  CP 0579 - 0580 - 0581
<p>p.143</p> <p>Tower unit with door and drawer Columna con puerta y cajón Colonne avec porte et tiroir</p>	<p>Depth / Profundidad / Profondeur (cm.): 45 - 61</p> <p>Width / Ancho / Largeur (cm.): 30 - 40 - 45 - 50 - 60</p>	 CCE 0582 - 0583  CE 0584 - 0585
<p>p.144</p> <p>Tower corner unit Módulo columna rinconero Module colonne encoignure</p>	<p>Depth / Profundidad / Profondeur (cm.): 61</p> <p>Door width / Ancho puerta / Largeur porte: 30 - 40 - 45 - 50 - 60</p>	 CRR 0587
<p>p.145</p> <p>Tower broom and cleaning product unit Columna para útiles de limpieza Colonne pour ustensiles de nettoyage</p>	<p>Depth / Profundidad / Profondeur (cm.): 35 - 45 - 61</p> <p>Width / Ancho / Largeur (cm.): 30 - 40 - 45 - 50 - 60</p>	 CUL 0592 - 0593 - 0594
<p>p.146 - 149</p> <p>Tower unit for oven and microwave Columna para horno y microondas Colonne pour four et micro-ondes</p>	<p>Depth / Profundidad / Profondeur (cm.): 61</p> <p>Width / Ancho / Largeur (cm.): 60 - 68,6 - 76,2 - 90 - 91,5</p>	 CHM 0627  CHM 0629  CHM 0630  CHM 0631  CHM 0632  CHM 0633  CHM 0634  CHM 0635  CHM 0636  CHM 0637  CHM 0638  CHM 0639
<p>p.150 - 151</p> <p>Tower unit for fridge Módulo columna para frigorífico Module colonne pour réfrigérateur</p>	<p>Depth / Profundidad / Profondeur (cm.): 61</p> <p>Width / Ancho / Largeur (cm.): 60 - 68,6 - 76,2 - 90 - 91,5</p>	 CFS 0657  CF 0658  CFS 0659  CF 0660

H. 222

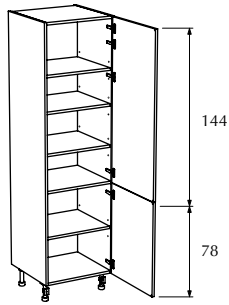

Tower unit with door.
2 doors.
1 fixed shelf.
4 shelves.

Módulo columna con puerta.
2 puertas.
1 balda fija.
4 baldas.

Module colonne avec porte.
2 portes.
1 étagère fixe.
4 étagères.

Availability / disponibilidad / disponibilité:

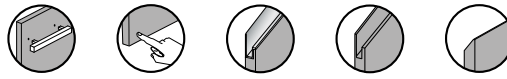

61 depth / profundidad / profondeur

SAP	Code Código Code	Width Ancho Largeur	Opening Apertura Ouverture											
				0	1	2	3	4	5	6	7	8	9	10
700021668	CP 0576	30	L / R	650	721	-	813	861	905	-	981	-	-	-
700021669	CP 0576	40	L / R	666	752	-	856	916	973	-	1062	-	-	-
700021670	CP 0576	45	L / R	680	771	-	880	940	998	-	1098	-	-	-
700021671	CP 0576	50	L / R	693	791	-	906	965	1029	-	1128	-	-	-
700021672	CP 0576	60	L / R	738	847	-	976	1033	1084	-	1201	-	-	-

45 depth / profundidad / profondeur

SAP	Code Código Code	Width Ancho Largeur	Opening Apertura Ouverture											
				0	1	2	3	4	5	6	7	8	9	10
700021673	CP 0577	30	L / R	600	673	-	760	808	852	-	927	-	-	-
700021674	CP 0577	40	L / R	621	709	-	808	852	908	-	1004	-	-	-
700021675	CP 0577	45	L / R	632	725	-	831	889	939	-	1037	-	-	-
700021676	CP 0577	50	L / R	644	743	-	855	913	968	-	1075	-	-	-
700021677	CP 0577	60	L / R	664	775	-	898	954	1025	-	1144	-	-	-

35 depth / profundidad / profondeur

SAP	Code Código Code	Width Ancho Largeur	Opening Apertura Ouverture											
				0	1	2	3	4	5	6	7	8	9	10
700021678	CP 0578	30	L / R	556	631	-	715	763	806	-	881	-	-	-
700021679	CP 0578	40	L / R	583	672	-	768	812	868	-	963	-	-	-
700021680	CP 0578	45	L / R	593	687	-	789	832	889	-	995	-	-	-
700021681	CP 0578	50	L / R	603	704	-	812	869	920	-	1013	-	-	-
700021682	CP 0578	60	L / R	620	733	-	852	907	961	-	1077	-	-	-

H. 222

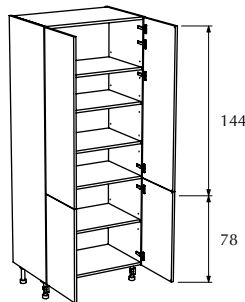

Tower unit with door.
4 doors.
1 fixed shelf.
4 shelves.

Módulo columna con puerta.
4 puertas.
1 balda fija.
4 baldas.

Module colonne avec porte.
4 portes.
1 étagère fixe.
4 étagères.

Availability / disponibilidad / disponibilité:

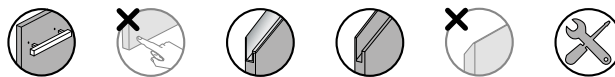

61 depth / profundidad / profondeur

SAP	Code Código Code	Width Ancho Largeur	Opening Apertura Ouverture											
				0	1	2	3	4	5	6	7	8	9	10
700021683	CP 0579	76,2	-	812	992	-	1149	1243	1333	-	1509	-	-	-
700021684	CP 0579	80	-	821	1015	-	1177	1276	1377	-	1561	-	-	-
700021685	CP 0579	90	-	849	1052	-	1226	1323	1426	-	1631	-	-	-
700021686	CP 0579	100	-	876	1092	-	1279	1387	1487	-	1712	-	-	-
700021687	CP 0579	120	-	943	1181	-	1394	1497	1610	-	1843	-	-	-

45 depth / profundidad / profondeur

SAP	Code Código Code	Width Ancho Largeur	Opening Apertura Ouverture											
				0	1	2	3	4	5	6	7	8	9	10
700021688	CP 0580	76,2	-	741	924	-	1075	1169	1259	-	1433	-	-	-
700021689	CP 0580	80	-	760	956	-	1113	1200	1313	-	1495	-	-	-
700021690	CP 0580	90	-	784	989	-	1158	1243	1346	-	1561	-	-	-
700021691	CP 0580	100	-	807	1026	-	1207	1301	1402	-	1639	-	-	-
700021692	CP 0580	120	-	848	1090	-	1294	1396	1511	-	1744	-	-	-

35 depth / profundidad / profondeur

SAP	Code Código Code	Width Ancho Largeur	Opening Apertura Ouverture											
				0	1	2	3	4	5	6	7	8	9	10
700021693	CP 0581	76,2	-	683	868	-	1014	1107	1198	-	1346	-	-	-
700021694	CP 0581	80	-	689	888	-	1039	1136	1238	-	1420	-	-	-
700021695	CP 0581	90	-	716	925	-	1088	1183	1288	-	1490	-	-	-
700021696	CP 0581	100	-	740	961	-	1136	1230	1344	-	1539	-	-	-
700021697	CP 0581	120	-	786	1031	-	1230	1331	1447	-	1680	-	-	-

Tower units
Columnas
Colonnes

Tower unit with door and drawer
Módulo columna con puerta y cajón
Module colonne avec porte et tiroir

H. 222

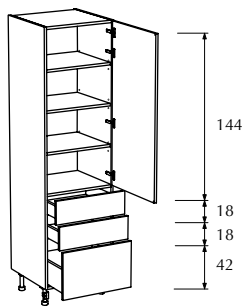

- Tower unit with door.
1 door.
2 drawers.
1 deep drawer.
1 fixed shelf.
3 shelves.

- Módulo columna con puerta.
1 puerta.
2 cajones.
1 gaveta.
1 balda fija.
3 baldas.

- Module colonne avec porte.
1 porte.
2 tiroirs.
1 extractible.
1 étagère fixe.
3 étagères.

Availability / disponibilidad / disponibilité:

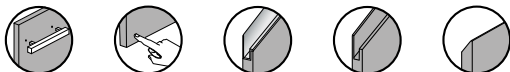

61 depth / profundidad / profondeur

SAP	Code Código Code	Width Ancho Largeur	Opening Apertura Ouverture	0	1	2	3	4	5	6	7	8	9	10
700021698	CCE 0582	30	L / R	1110	1216	-	1377	1455	1521	-	1639	-	-	-
700021699	CCE 0582	40	L / R	1132	1248	-	1410	1496	1566	-	1690	-	-	-
700021700	CCE 0582	45	L / R	1150	1275	-	1443	1531	1607	-	1743	-	-	-
700021701	CCE 0582	50	L / R	1165	1295	-	1470	1557	1634	-	1764	-	-	-
700021702	CCE 0582	60	L / R	1213	1355	-	1545	1631	1716	-	1867	-	-	-

45 depth / profundidad / profondeur

SAP	Code Código Code	Width Ancho Largeur	Opening Apertura Ouverture	0	1	2	3	4	5	6	7	8	9	10
700021703	CCE 0583	30	L / R	1081	1188	-	1334	1425	1491	-	1608	-	-	-
700021704	CCE 0583	40	L / R	1110	1227	-	1387	1473	1543	-	1651	-	-	-
700021705	CCE 0583	45	L / R	1126	1252	-	1418	1506	1583	-	1701	-	-	-
700021706	CCE 0583	50	L / R	1139	1270	-	1443	1530	1607	-	1736	-	-	-
700021707	CCE 0583	60	L / R	1165	1310	-	1495	1582	1666	-	1816	-	-	-

H. 222

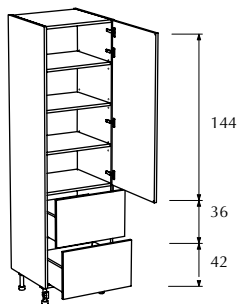

- Tower unit with door.
1 door.
2 deep drawers.
1 fixed shelf.
3 shelves.

- Módulo columna con puerta.
1 puerta.
2 gavetas.
1 balda fija.
3 baldas.

- Module colonne avec porte.
1 porte.
2 extractibles.
1 étagère fixe.
3 étagères.

Availability / disponibilidad / disponibilité:



61 depth / profundidad / profondeur

SAP	Code Código Code	Width Ancho Largeur	Opening Apertura Ouverture	0	1	2	3	4	5	6	7	8	9	10
700021708	CE 0584	30	L / R	1002	1087	-	1223	1309	1387	-	1500	-	-	-
700021709	CE 0584	40	L / R	1020	1116	-	1264	1346	1428	-	1548	-	-	-
700021710	CE 0584	45	L / R	1037	1140	-	1295	1385	1467	-	1598	-	-	-
700021711	CE 0584	50	L / R	1050	1158	-	1319	1409	1491	-	1625	-	-	-
700021712	CE 0584	60	L / R	1094	1212	-	1387	1474	1558	-	1706	-	-	-

45 depth / profundidad / profondeur

SAP	Code Código Code	Width Ancho Largeur	Opening Apertura Ouverture	0	1	2	3	4	5	6	7	8	9	10
700021713	CE 0585	30	L / R	970	1056	-	1189	1276	1353	-	1465	-	-	-
700021714	CE 0585	40	L / R	994	1091	-	1236	1319	1400	-	1520	-	-	-
700021715	CE 0585	45	L / R	1009	1113	-	1265	1356	1437	-	1568	-	-	-
700021716	CE 0585	50	L / R	1020	1130	-	1288	1378	1460	-	1593	-	-	-
700021717	CE 0585	60	L / R	1043	1163	-	1333	1420	1505	-	1652	-	-	-

H. 222

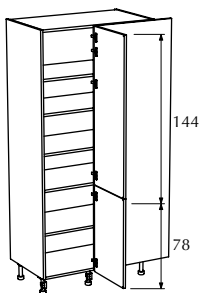

Tower straight corner unit.
2 doors.
1 fixed shelf.
4 shelves.
Unit for standard corner filler, 10x10 cm.
Order corner filler separately to insert between add-on units for 90° union.

Módulo columna rinconero recto.
2 puertas.
1 balda fija.
4 baldas.
Módulo para regletas de unión estándar, 10x10 cm.
Solicitar regleta de unión por separado.

Modules colonne encoignure droite.
2 portes.
1 étagère fixe.
4 étagères.
Module pour fileur d'encoignure standard, 10x10 cm.
Commander fileur d'union séparément.

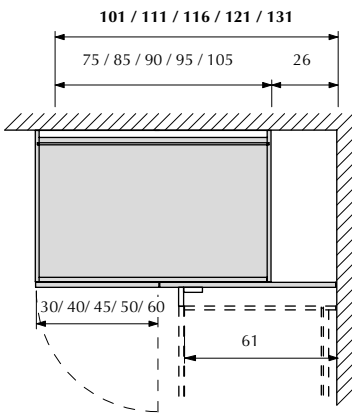

Availability / disponibilidad / disponibilité:

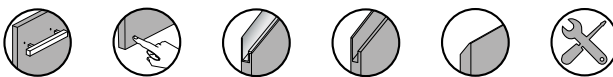

61 depth / profundidad / profondeur

SAP	Code Código Code	Width Ancho Largeur	Opening Apertura Ouverture	0	1	2	3	4	5	6	7	8	9	10
700021723	CRR 0587	101	L / R	786	995	-	1156	1203	1271	-	1444	-	-	-
700021724	CRR 0587	111	L / R	809	1032	-	1205	1249	1325	-	1516	-	-	-
700021725	CRR 0587	116	L / R	821	1052	-	1230	1279	1359	-	1560	-	-	-
700021726	CRR 0587	121	L / R	838	1075	-	1259	1304	1388	-	1598	-	-	-
700021727	CRR 0587	131	L / R	861	1108	-	1304	1342	1434	-	1662	-	-	-

H. 222

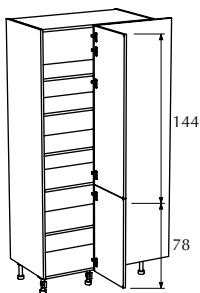

Tower straight corner unit.
2 doors.
1 fixed shelf.
4 shelves.
Unit for corner filler with raised door profile 4x4 cm.
Order corner filler separately to insert between add-on units for 90° union.

Módulo columna rinconero recto.
2 puertas.
1 balda fija.
4 baldas.
Módulo para regleta de rincón con perfil de puerta de 4x4 cm.
Solicitar regleta de unión por separado.

Modules colonne encoignure droite.
2 portes.
1 étagère fixe.
4 étagères.
Module pour fileur d'encoignure avec profilé de porte, 4x4 cm.
Commander fileur d'union séparément.

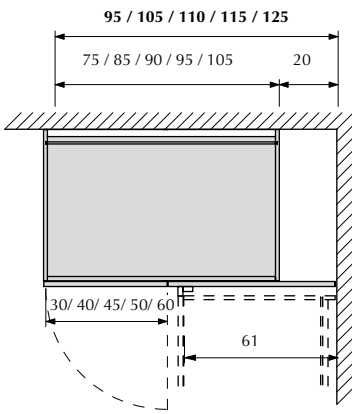

Availability / disponibilidad / disponibilité:

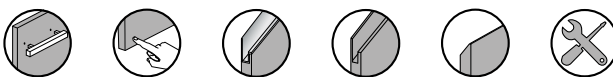

61 depth / profundidad / profondeur

SAP	Code Código Code	Width Ancho Largeur	Opening Apertura Ouverture	0	1	2	3	4	5	6	7	8	9	10
700022048	CRR 0587	95	L / R	786	995	-	1156	1203	1271	-	1444	-	-	-
700022049	CRR 0587	105	L / R	809	1032	-	1205	1249	1325	-	1516	-	-	-
700022050	CRR 0587	110	L / R	821	1052	-	1230	1279	1359	-	1560	-	-	-
700022051	CRR 0587	115	L / R	838	1075	-	1259	1304	1388	-	1598	-	-	-
700022052	CRR 0587	125	L / R	861	1108	-	1304	1342	1434	-	1662	-	-	-

Tower units
Columnas
Colonnes

Tower broom and cleaning product unit
Módulo columna para útiles de limpieza
Modules colonne pour utensiles de nettoyage

H. 222

Tower broom and cleaning product unit.
2 doors.
1 fixed shelf.
1 shelf.

Módulo columna para útiles de limpieza.
2 puertas.
1 balda fija.
1 balda.

Colonne pour utensiles de nettoyage.
2 portes.
1 étagère fixe.
1 étagère

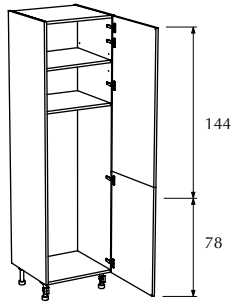

Availability / disponibilidad / disponibilité:

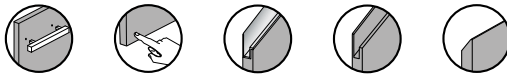

61 depth / profundidad / profondeur

SAP	Code Código Code	Width Ancho Largeur	Opening Apertura Ouverture											
				0	1	2	3	4	5	6	7	8	9	10
700021746	CUL 0592	30	L / R	562	636	-	727	768	812	-	887	-	-	-
700021747	CUL 0592	40	L / R	569	657	-	759	801	848	-	943	-	-	-
700021748	CUL 0592	45	L / R	580	676	-	777	836	889	-	986	-	-	-
700021749	CUL 0592	50	L / R	587	689	-	796	853	908	-	1015	-	-	-
700021750	CUL 0592	60	L / R	616	727	-	846	898	950	-	1067	-	-	-

45 depth / profundidad / profondeur

SAP	Code Código Code	Width Ancho Largeur	Opening Apertura Ouverture											
				0	1	2	3	4	5	6	7	8	9	10
700021751	CUL 0593	30	L / R	518	594	-	674	722	766	-	840	-	-	-
700021752	CUL 0593	40	L / R	531	621	-	713	769	824	-	903	-	-	-
700021753	CUL 0593	45	L / R	541	639	-	737	795	848	-	945	-	-	-
700021754	CUL 0593	50	L / R	548	651	-	754	810	858	-	955	-	-	-
700021755	CUL 0593	60	L / R	561	675	-	789	841	893	-	1010	-	-	-

35 depth / profundidad / profondeur

SAP	Code Código Code	Width Ancho Largeur	Opening Apertura Ouverture											
				0	1	2	3	4	5	6	7	8	9	10
700021756	CUL 0594	30	L / R	482	560	-	643	685	729	-	802	-	-	-
700021757	CUL 0594	40	L / R	499	590	-	679	735	782	-	869	-	-	-
700021758	CUL 0594	45	L / R	508	608	-	702	760	821	-	910	-	-	-
700021759	CUL 0594	50	L / R	514	619	-	719	775	838	-	937	-	-	-
700021760	CUL 0594	60	L / R	526	642	-	752	803	857	-	973	-	-	-

H. 222

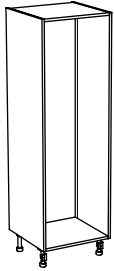

Carcass for tower unit kit for oven and microwave.

Comments:
Must be filled with units for oven and microwave tower unit kit.
See instructions on chapter 01.

Casco para kit columna de horno y microondas.

Observaciones:
Se debe completar con módulos para kit columna horno y microondas.
Ver instrucciones en capítulos 01.

Caisson pour kit colonne pour four et micro-ondes.

Remarques:
Doit être complétés avec les modules pour kit colonne four et micro-ondes.
Voir instructions en chapitre 01.

Availability / disponibilidad / disponibilité:



61 depth / profundidad / profondeur				
SAP	Code Código Code	Width Ancho Largeur	Opening Apertura Ouverture	Carcass colour Color de casco Couleur de caisson
700021905	CHM 0627	60	-	418
700021906	CHM 0627	68,6	-	422
700021907	CHM 0627	76,2	-	426
700021908	CHM 0627	90	-	434
700021909	CHM 0627	91,5	-	434

H. 222

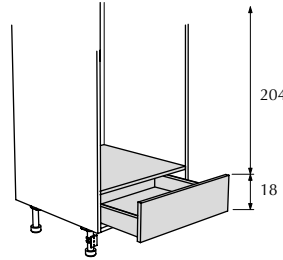

Lower unit with drawers for kit for oven and microwave.

1 drawer.
1 top shelf.
1 back panel.
H 18

Módulo inferior con cajones para kit columna de horno y microondas.

1 cajón.
1 techo.
1 trasera.
H 18

Module inférieur avec tiroirs pour four et micro-ondes.

1 tiroir.
1 joue superieure.
1 panneau arrière.
H 18

Availability / disponibilidad / disponibilité:

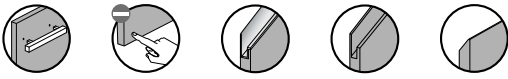

61 depth / profundidad / profondeur														
SAP	Code Código Code	Width Ancho Largeur	Opening Apertura Ouverture	0	1	2	3	4	5	6	7	8	9	10
700021915	CHM 0629	60	-	285	308	-	353	376	387	-	407	-	-	-
700021916	CHM 0629	68,6	-	295	318	-	365	391	402	-	421	-	-	-
700021917	CHM 0629	76,2	-	303	327	-	376	403	413	-	433	-	-	-
700021918	CHM 0629	90	-	312	338	-	389	415	426	-	448	-	-	-
700021919	CHM 0629	91,5	-	313	339	-	390	418	431	-	450	-	-	-

H. 222

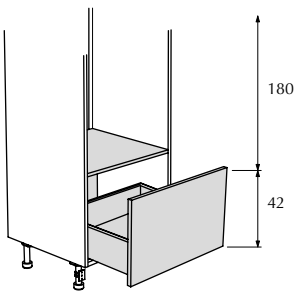

Lower unit with drawers for kit for oven and microwave.

1 deep drawer.
1 top shelf.
1 back panel.
H 42

Módulo inferior con cajones para kit columna de horno y microondas.

1 gaveta.
1 techo.
1 trasera.
H 42

Module inférieur avec tiroirs pour four et micro-ondes.

1 extractible.
1 joue superieure.
1 panneau arrière.
H 42

Availability / disponibilidad / disponibilité:

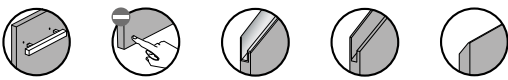

61 depth / profundidad / profondeur														
SAP	Code Código Code	Width Ancho Largeur	Opening Apertura Ouverture	0	1	2	3	4	5	6	7	8	9	10
700021920	CHM 0630	60	-	332	361	-	407	435	455	-	486	-	-	-
700021921	CHM 0630	68,6	-	342	372	-	421	450	469	-	504	-	-	-
700021922	CHM 0630	76,2	-	353	388	-	440	470	492	-	530	-	-	-
700021923	CHM 0630	90	-	363	400	-	455	484	504	-	542	-	-	-
700021924	CHM 0630	91,5	-	364	401	-	457	488	508	-	544	-	-	-

H. 222

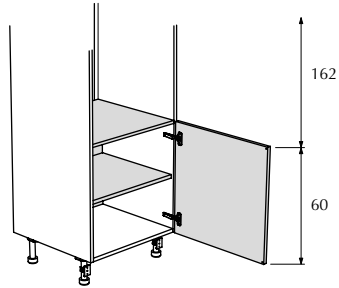

Lower unit with door for kit for oven and microwave.
1 door.
1 shelf.
1 top shelf.
1 back panel.
H 60

Módulo inferior con puerta para kit columna de horno y microondas.
1 puerta.
1 balda.
1 techo.
1 trasera.
H 60

Module inférieur avec porte pour four et micro-ondes.
1 porte.
1 étagère.
1 joue supérieure.
1 panneau arrière.
H 60

Availability / disponibilidad / disponibilité:

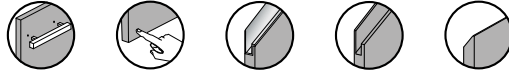

61 depth / profundidad / profondeur

SAP	Code Código Code	Width Ancho Largeur	Opening Apertura Ouverture											
				0	1	2	3	4	5	6	7	8	9	10
700021925	CHM 0631	60	-	172	216	-	257	278	297	-	329	-	-	-
700021926	CHM 0631	68,6	-	178	224	-	268	291	314	-	351	-	-	-
700021927	CHM 0631	76,2	-	183	231	-	273	301	324	-	358	-	-	-

H. 222

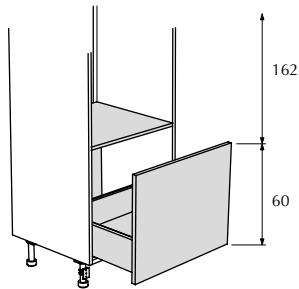

Lower unit with drawers for kit for oven and microwave.
1 deep drawer.
1 top shelf.
1 back panel.
H 60

Módulo inferior con cajones para kit columna de horno y microondas.
1 gaveta.
1 techo.
1 trasera.
H 60

Module inférieur avec tiroirs pour four et micro-ondes.
1 extractible.
1 joue supérieure.
1 panneau arrière.
H 60

Availability / disponibilidad / disponibilité:

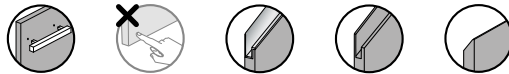

61 depth / profundidad / profondeur

SAP	Code Código Code	Width Ancho Largeur	Opening Apertura Ouverture											
				0	1	2	3	4	5	6	7	8	9	10
700021928	CHM 0632	60	-	338	375	-	423	452	475	-	511	-	-	-
700021929	CHM 0632	68,6	-	348	388	-	439	469	491	-	527	-	-	-
700021930	CHM 0632	76,2	-	357	398	-	453	483	505	-	545	-	-	-
700021931	CHM 0632	90	-	367	412	-	471	507	529	-	566	-	-	-
700021932	CHM 0632	91,5	-	368	414	-	473	509	531	-	569	-	-	-

H. 222

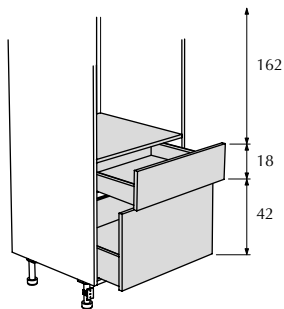

Lower unit with drawers for kit for oven and microwave.
1 drawer.
1 deep drawer.
1 top shelf.
1 back panel.
H 60

Módulo inferior con cajones para kit columna de horno y microondas.
1 cajón.
1 gaveta.
1 techo.
1 trasera.
H 60

Module inférieur avec tiroirs pour four et micro-ondes.
1 tiroir.
1 extractible.
1 joue supérieure.
1 panneau arrière.
H 60

Availability / disponibilidad / disponibilité:



61 depth / profundidad / profondeur

SAP	Code Código Code	Width Ancho Largeur	Opening Apertura Ouverture											
				0	1	2	3	4	5	6	7	8	9	10
700021933	CHM 0633	60	-	504	560	-	637	692	725	-	771	-	-	-
700021934	CHM 0633	68,6	-	521	579	-	660	721	748	-	792	-	-	-
700021935	CHM 0633	76,2	-	536	599	-	691	746	776	-	817	-	-	-
700021936	CHM 0633	90	-	551	618	-	702	768	801	-	850	-	-	-
700021937	CHM 0633	91,5	-	552	620	-	705	770	804	-	853	-	-	-

H. 222

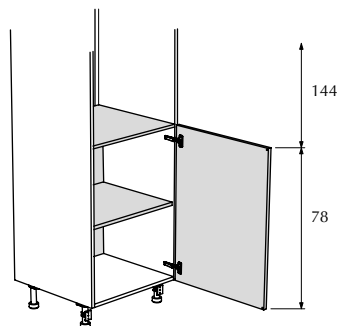

Lower unit with door for kit for oven and microwave.
1 door.
1 shelf.
1 top shelf.
1 back panel.

H 78

Módulo inferior con puerta para kit columna de horno y microondas.
1 puerta.
1 balda.
1 techo.
1 trasera.

H 78

Module inférieur avec porte pour four et micro-ondes.
1 porte.
1 étagère.
1 joue supérieure.
1 panneau arrière.

H 78

Availability / disponibilidad / disponibilité:

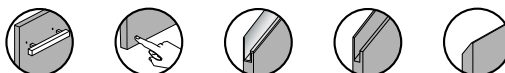

61 depth / profundidad / profondeur

SAP	Code Código Code	Width Ancho Largeur	Opening Apertura Ouverture											
				0	1	2	3	4	5	6	7	8	9	10
700021938	CHM 0634	60	-	175	225	-	263	288	311	-	352	-	-	-
700021939	CHM 0634	68,6	-	181	234	-	276	301	327	-	371	-	-	-
700021940	CHM 0634	76,2	-	187	242	-	287	312	339	-	388	-	-	-

H. 222

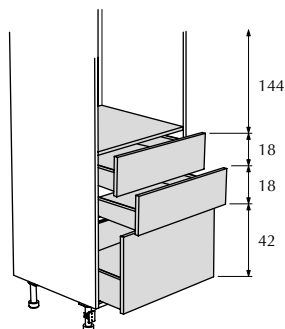

Lower unit with drawers for kit for oven and microwave.
2 drawers.
1 deep drawer.
1 top shelf.
1 back panel.

H 78

Módulo inferior con cajones para kit columna de horno y microondas.
2 cajones.
1 gaveta.
1 techo.
1 trasera.

H 78

Module inférieur avec tiroirs pour four et micro-ondes.
2 tiroirs.
1 extractible.
1 joue supérieure.
1 panneau arrière.

H 78

Availability / disponibilidad / disponibilité:

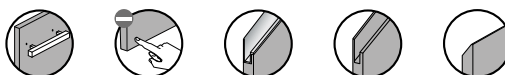

61 depth / profundidad / profondeur

SAP	Code Código Code	Width Ancho Largeur	Opening Apertura Ouverture											
				0	1	2	3	4	5	6	7	8	9	10
700021941	CHM 0635	60	-	674	758	-	853	931	974	-	1043	-	-	-
700021942	CHM 0635	68,6	-	697	784	-	884	971	1024	-	1092	-	-	-
700021943	CHM 0635	76,2	-	718	811	-	916	1005	1051	-	1124	-	-	-
700021944	CHM 0635	90	-	740	839	-	951	1036	1077	-	1159	-	-	-
700021945	CHM 0635	91,5	-	743	841	-	955	1046	1100	-	1186	-	-	-

H. 222

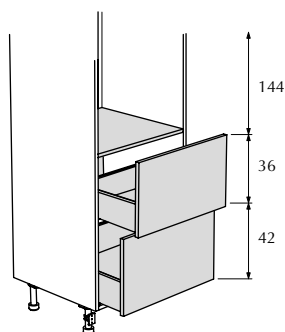

Lower unit with drawers for kit for oven and microwave.
2 deep drawers.
1 top shelf.
1 back panel.

H 78

Módulo inferior con cajones para kit columna de horno y microondas.
2 gavetas.
1 techo.
1 trasera.

H 78

Module inférieur avec tiroirs pour four et micro-ondes.
2 extractibles.
1 joue supérieure.
1 panneau arrière.

H 78

Availability / disponibilidad / disponibilité:

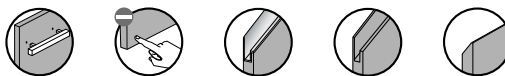

61 depth / profundidad / profondeur

SAP	Code Código Code	Width Ancho Largeur	Opening Apertura Ouverture											
				0	1	2	3	4	5	6	7	8	9	10
700021946	CHM 0636	60	-	550	610	-	690	764	826	-	901	-	-	-
700021947	CHM 0636	68,6	-	567	630	-	735	800	852	-	934	-	-	-
700021948	CHM 0636	76,2	-	582	651	-	761	824	874	-	952	-	-	-
700021949	CHM 0636	90	-	599	676	-	794	855	906	-	1004	-	-	-
700021950	CHM 0636	91,5	-	601	678	-	797	864	917	-	1008	-	-	-

H. 222

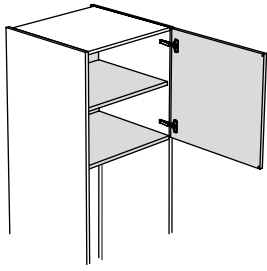

Upper unit with door for kit for oven and microwave.
1 door.
1 Shelf.
1 base shelf.
1 back panel.
Variable height.
Minimum height, 30 cm.

Módulo superior con puerta para kit columna de horno y microondas.
1 puerta.
1 balda.
1 base.
1 trasera.
Altura variable.
Altura mínima, 30 cm.

Modules supérieur avec porte pour four et micro-ondes.
1 porte.
1 étagère.
1 joue inférieure.
1 panneau arrière.
Hauteur variable.
Hauteur minimale de 30 cm.

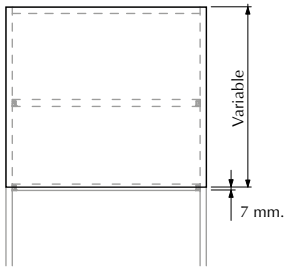

Availability / disponibilidad / disponibilité:

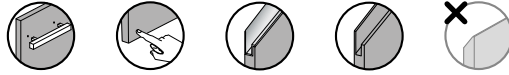

61 depth / profundidad / profondeur

SAP	Code Código Code	Width Ancho Largeur	Opening Apertura Ouverture											
				0	1	2	3	4	5	6	7	8	9	10
700021951	CHM 0637	60	-	177	230	-	273	300	327	-	368	-	-	-
700021952	CHM 0637	68,6	-	184	244	-	290	320	352	-	400	-	-	-
700021953	CHM 0637	76,2	-	191	254	-	304	335	367	-	420	-	-	-

H. 222

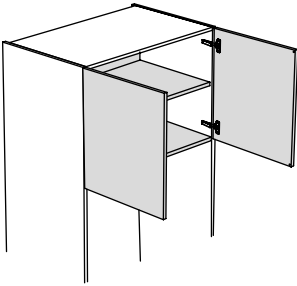

Upper unit with door for kit for oven and microwave.
2 doors.
1 Shelf.
1 base shelf.
1 back panel.
Variable height.
Minimum height, 30 cm.

Módulo superior con puerta para kit columna de horno y microondas.
2 puertas.
1 balda.
1 base.
1 trasera.
Altura variable.
Altura mínima, 30 cm.

Modules supérieur avec porte pour four et micro-ondes.
2 portes.
1 étagère.
1 joue inférieure.
1 panneau arrière.
Hauteur variable.
Hauteur minimale de 30 cm.

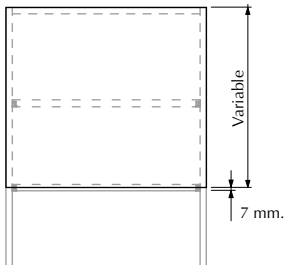

Availability / disponibilidad / disponibilité:

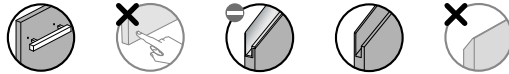

61 depth / profundidad / profondeur

SAP	Code Código Code	Width Ancho Largeur	Opening Apertura Ouverture											
				0	1	2	3	4	5	6	7	8	9	10
700021954	CHM 0638	76,2	-	207	299	-	367	409	457	-	518	-	-	-
700021955	CHM 0638	90	-	217	315	-	379	425	476	-	542	-	-	-
700021956	CHM 0638	91,5	-	218	325	-	397	450	498	-	576	-	-	-

H. 222

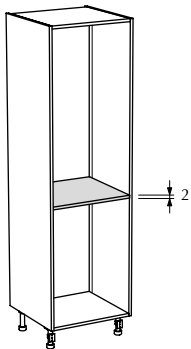

Shelf for kit for oven and microwave.
1 shelf.
H 2

Balda para kit columna de horno y microondas.
1 balda.
H 2

Étagère pour four et micro-ondes.
1 étagère.
H 2

61 depth / profundidad / profondeur

SAP	Code Código Code	Width Ancho Largeur	Opening Apertura Ouverture	Carcass colour
				Color de casco Couleur de caisson
700021957	CHM 0639	60	-	66
700021958	CHM 0639	68,6	-	69
700021959	CHM 0639	76,2	-	71
700021960	CHM 0639	90	-	74
700021961	CHM 0639	91,5	-	74

Tower units
Columnas
Colonnes

Tower unit for fridge
Módulo columna para frigorífico
Module colonne pour réfrigérateur

H. 222

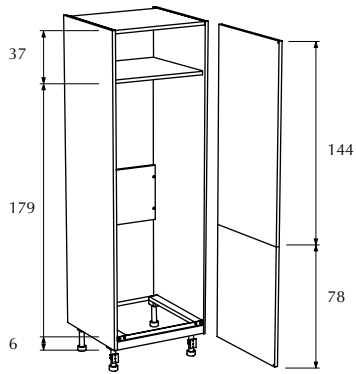

Tower unit for fridge.
2 doors.
1 structure with ventilation grille.
1 shelf.
1 back panel.
WITHOUT hinges.

Columna de frigorífico.
2 puertas.
1 estructura con rejilla de ventilación.
1 balda.
1 trasera.
SIN bisagras.

Colonne réfrigérateur.
2 portes.
1 structure avec grille d'aération.
1 étagère.
1 panneau arrière.
SANS charnières.

Availability / disponibilidad / disponibilité:

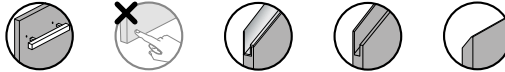

61 depth / profundidad / profondeur

SAP	Code Código Code	Width Ancho Largeur	Opening Apertura Ouverture	0	1	2	3	4	5	6	7	8	9	10
				700021978	CFS 0657	60	-	649	759	-	881	934	994	-

H. 222

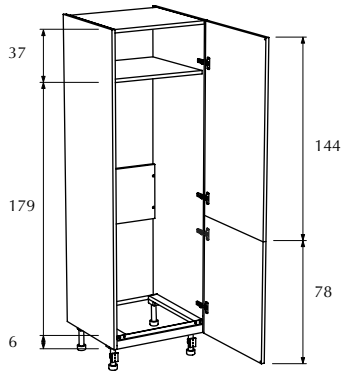

Tower unit for fridge.
2 doors.
1 structure with ventilation grille.
1 shelf.
1 back panel.
WITH hinges.

Columna de frigorífico.
2 puertas.
1 estructura con rejilla de ventilación.
1 balda.
1 trasera.
CON bisagras.

Colonne réfrigérateur.
2 portes.
1 structure avec grille d'aération.
1 étagère.
1 panneau arrière.
AVEC charnières.

Availability / disponibilidad / disponibilité:

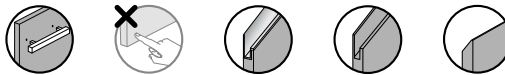

61 depth / profundidad / profondeur

SAP	Code Código Code	Width Ancho Largeur	Opening Apertura Ouverture	0	1	2	3	4	5	6	7	8	9	10
				700021979	CF 0658	60	L / R	649	759	-	881	934	994	-

Tower units
Columnas
Colonnes

Tower unit for fridge
Módulo columna para frigorífico
Module colonne pour réfrigérateur

H. 222

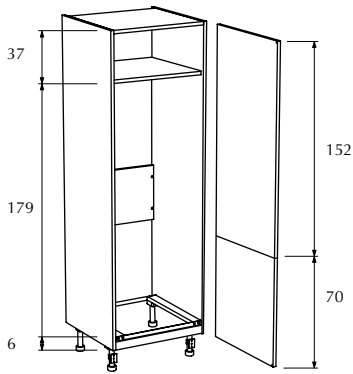

Tower unit for fridge.
2 doors.
1 structure with ventilation grille.
1 shelf.
1 back panel.
WITHOUT hinges.

Columna de frigorífico.
2 puertas.
1 estructura con rejilla de ventilación.
1 balda.
1 trasera.
SIN bisagras.

Colonne réfrigérateur.
2 portes.
1 structure avec grille d'aération.
1 étagère.
1 panneau arrière.
SANS charnières.

Availability / disponibilidad / disponibilité:

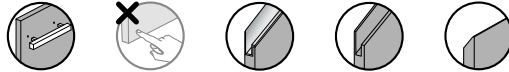

61 depth / profundidad / profondeur

SAP	Code Código Code	Width Ancho Largeur	Opening Apertura Ouverture	0	1	2	3	4	5	6	7	8	9	10
				700021980	CFS 0659	60	-	649	763	-	884	946	1015	-

H. 222

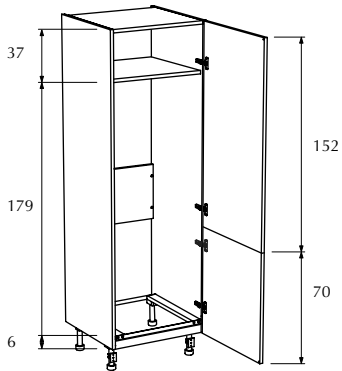

Tower unit for fridge.
2 doors.
1 structure with ventilation grille.
1 shelf.
1 back panel.
WITH hinges.

Columna de frigorífico.
2 puertas.
1 estructura con rejilla de ventilación.
1 balda.
1 trasera.
CON bisagras.

Colonne réfrigérateur.
2 portes.
1 structure avec grille d'aération.
1 étagère.
1 panneau arrière.
AVEC charnières.

Availability / disponibilidad / disponibilité:

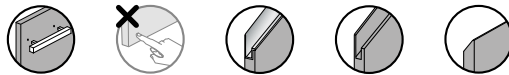

















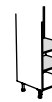

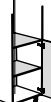

61 depth / profundidad / profondeur

SAP	Code Código Code	Width Ancho Largeur	Opening Apertura Ouverture	0	1	2	3	4	5	6	7	8	9	10
				700021981	CF 0660	60	L / R	649	763	-	884	946	1015	-

h. 234

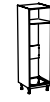
Tower units
Columnas
Colonnes

Type of unit Tipo de módulo Type de module	Available measures Medidas disponibles Dimensions disponibles	Available units Módulos disponibles Modules disponibles
<p>p.154 Tower unit with door Columna con puerta Colonne avec porte</p>	<p>Depth / Profundidad / Profondeur (cm.): 35 - 45 - 61</p> <p>Width / Ancho / Largeur (cm.): 30 - 40 - 45 - 50 - 60 (1 door) 76,2 - 80 - 90 - 100 - 120 (2 doors)</p>	 CP 0603 - 0604 - 0605  CP 0606 - 0607 - 0608
<p>p.155 Tower unit with door and drawer Columna con puerta y cajón Colonne avec porte et tiroir</p>	<p>Depth / Profundidad / Profondeur (cm.): 45 - 61</p> <p>Width / Ancho / Largeur (cm.): 30 - 40 - 45 - 50 - 60</p>	 CCE 0609 - 0610  CE 0611 - 0612
<p>p.156 Tower corner unit Módulo columna rinconero Module colonne encoignure</p>	<p>Depth / Profundidad / Profondeur (cm.): 61</p> <p>Door width / Ancho puerta / Largeur porte: 30 - 40 - 45 - 50 - 60</p>	 CRR 0614
<p>p.157 Tower broom and cleaning product unit Columna para útiles de limpieza Colonne pour ustensiles de nettoyage</p>	<p>Depth / Profundidad / Profondeur (cm.): 35 - 45 - 61</p> <p>Width / Ancho / Largeur (cm.): 30 - 40 - 45 - 50 - 60</p>	 CUL 0619 - 0620 - 0621
<p>p.158 - 161 Tower unit for oven and microwave Columna para horno y microondas Colonne pour four et micro-ondes</p>	<p>Depth / Profundidad / Profondeur (cm.): 61</p> <p>Width / Ancho / Largeur (cm.): 60 - 68,6 - 76,2 - 90 - 91,5</p>	 CHM 0628  CHM 0629  CHM 0630  CHM 0631  CHM 0632  CHM 0633  CHM 0634  CHM 0635  CHM 0636  CHM 0637  CHM 0638  CHM 0639
<p>p.162 - 163 Tower unit for fridge Módulo columna para frigorífico Module colonne pour réfrigérateur</p>	<p>Depth / Profundidad / Profondeur (cm.): 61</p> <p>Width / Ancho / Largeur (cm.): 60 - 68,6 - 76,2 - 90 - 91,5</p>	 CFS 0663  CF 0664  CFS 0665  CF 0666

H. 234

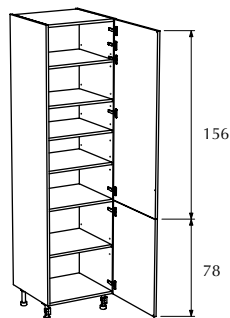

Tower unit with door.
2 doors.
1 fixed shelf.
5 shelves.

Módulo columna con puerta.
2 puertas.
1 balda fija.
5 baldas.

Module colonne avec porte.
2 portes.
1 étagère fixe.
5 étagères.

Availability / disponibilidad / disponibilité:

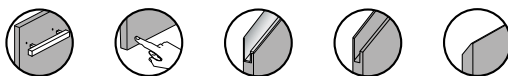

61 depth / profundidad / profondeur

SAP	Code Código Code	Width Ancho Largeur	Opening Apertura Ouverture											
				0	1	2	3	4	5	6	7	8	9	10
700021794	CP 0603	30	L / R	663	735	-	830	876	922	-	1002	-	-	-
700021795	CP 0603	40	L / R	680	769	-	876	924	980	-	1082	-	-	-
700021796	CP 0603	45	L / R	696	790	-	904	954	1008	-	1120	-	-	-
700021797	CP 0603	50	L / R	708	808	-	928	985	1041	-	1155	-	-	-
700021798	CP 0603	60	L / R	756	869	-	1003	1060	1116	-	1238	-	-	-

45 depth / profundidad / profondeur

SAP	Code Código Code	Width Ancho Largeur	Opening Apertura Ouverture											
				0	1	2	3	4	5	6	7	8	9	10
700021799	CP 0604	30	L / R	610	685	-	775	822	867	-	946	-	-	-
700021800	CP 0604	40	L / R	631	723	-	826	885	938	-	1030	-	-	-
700021801	CP 0604	45	L / R	645	742	-	851	910	964	-	1067	-	-	-
700021802	CP 0604	50	L / R	656	758	-	873	929	977	-	1080	-	-	-
700021803	CP 0604	60	L / R	677	793	-	921	985	1052	-	1178	-	-	-

35 depth / profundidad / profondeur

SAP	Code Código Code	Width Ancho Largeur	Opening Apertura Ouverture											
				0	1	2	3	4	5	6	7	8	9	10
700021804	CP 0605	30	L / R	565	641	-	727	777	827	-	897	-	-	-
700021805	CP 0605	40	L / R	592	685	-	784	843	896	-	988	-	-	-
700021806	CP 0605	45	L / R	604	702	-	808	865	912	-	1004	-	-	-
700021807	CP 0605	50	L / R	613	717	-	828	883	932	-	1035	-	-	-
700021808	CP 0605	60	L / R	631	749	-	872	927	985	-	1108	-	-	-

H. 234

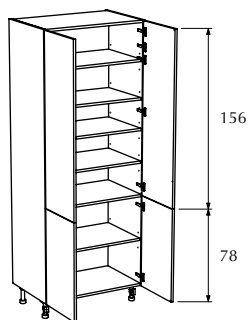

Tower unit with door.
4 doors.
1 fixed shelf.
5 shelves.

Módulo columna con puerta.
4 puertas.
1 balda fija.
5 baldas.

Module colonne avec porte.
4 portes.
1 étagère fixe.
5 étagères.

Availability / disponibilidad / disponibilité:

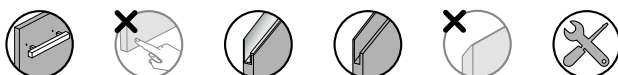

61 depth / profundidad / profondeur

SAP	Code Código Code	Width Ancho Largeur	Opening Apertura Ouverture											
				0	1	2	3	4	5	6	7	8	9	10
700021809	CP 0606	76,2	-	835	1019	-	1182	1272	1366	-	1536	-	-	-
700021810	CP 0606	80	-	845	1045	-	1214	1313	1422	-	1600	-	-	-
700021811	CP 0606	90	-	876	1087	-	1269	1372	1477	-	1661	-	-	-
700021812	CP 0606	100	-	902	1123	-	1318	1422	1526	-	1731	-	-	-
700021813	CP 0606	120	-	973	1221	-	1442	1552	1668	-	1913	-	-	-

45 depth / profundidad / profondeur

SAP	Code Código Code	Width Ancho Largeur	Opening Apertura Ouverture											
				0	1	2	3	4	5	6	7	8	9	10
700021814	CP 0607	76,2	-	759	946	-	1103	1193	1287	-	1470	-	-	-
700021815	CP 0607	80	-	780	983	-	1146	1245	1354	-	1546	-	-	-
700021816	CP 0607	90	-	807	1021	-	1197	1293	1405	-	1619	-	-	-
700021817	CP 0607	100	-	829	1053	-	1241	1344	1450	-	1654	-	-	-
700021818	CP 0607	120	-	872	1125	-	1337	1445	1563	-	1808	-	-	-

35 depth / profundidad / profondeur

SAP	Code Código Code	Width Ancho Largeur	Opening Apertura Ouverture											
				0	1	2	3	4	5	6	7	8	9	10
700021819	CP 0608	76,2	-	698	888	-	1039	1129	1223	-	1379	-	-	-
700021820	CP 0608	80	-	705	911	-	1068	1166	1276	-	1466	-	-	-
700021821	CP 0608	90	-	736	952	-	1122	1217	1330	-	1528	-	-	-
700021822	CP 0608	100	-	757	985	-	1167	1268	1375	-	1594	-	-	-
700021823	CP 0608	120	-	807	1062	-	1270	1376	1495	-	1756	-	-	-

H. 234

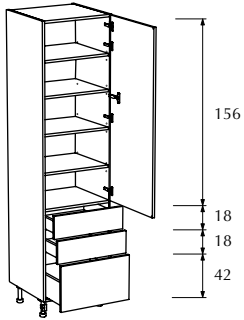

Tower unit with door.
1 door.
2 drawers.
1 deep drawer.
1 fixed shelf.
4 shelves.

Módulo columna con puerta.
1 puerta.
2 cajones.
1 gaveta.
1 balda fija.
4 baldas.

Module colonne avec porte.
1 porte.
2 tiroirs.
1 extractible.
1 étagère fixe.
4 étagères.

Availability / disponibilidad / disponibilité:

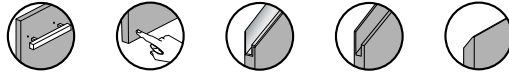

61 depth / profundidad / profondeur

SAP	Code Código Code	Width Ancho Largeur	Opening Apertura Ouverture	0	1	2	3	4	5	6	7	8	9	10
700021824	CCE 0609	30	L / R	1146	1252	-	1394	1481	1563	-	1670	-	-	-
700021825	CCE 0609	40	L / R	1170	1291	-	1459	1545	1623	-	1753	-	-	-
700021826	CCE 0609	45	L / R	1190	1316	-	1491	1576	1655	-	1780	-	-	-
700021827	CCE 0609	50	L / R	1207	1338	-	1506	1603	1699	-	1837	-	-	-
700021828	CCE 0609	60	L / R	1260	1407	-	1605	1698	1784	-	1979	-	-	-

45 depth / profundidad / profondeur

SAP	Code Código Code	Width Ancho Largeur	Opening Apertura Ouverture	0	1	2	3	4	5	6	7	8	9	10
700021829	CCE 0610	30	L / R	1114	1222	-	1373	1461	1543	-	1651	-	-	-
700021830	CCE 0610	40	L / R	1145	1267	-	1432	1526	1596	-	1725	-	-	-
700021831	CCE 0610	45	L / R	1162	1290	-	1462	1561	1641	-	1767	-	-	-
700021832	CCE 0610	50	L / R	1177	1309	-	1488	1579	1668	-	1804	-	-	-
700021833	CCE 0610	60	L / R	1205	1355	-	1547	1649	1742	-	1901	-	-	-

H. 234

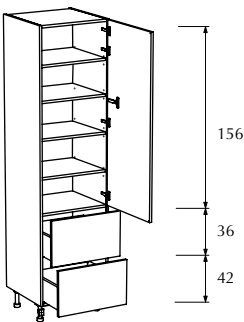

Tower unit with door.
1 door.
2 deep drawers.
1 fixed shelf.
4 shelves.

Módulo columna con puerta.
1 puerta.
2 gavetas.
1 balda fija.
4 baldas.

Module colonne avec porte.
1 porte.
2 extractibles.
1 étagère fixe.
4 étagères.

Availability / disponibilidad / disponibilité:

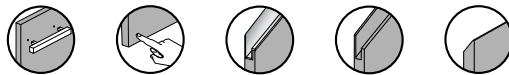

61 depth / profundidad / profondeur

SAP	Code Código Code	Width Ancho Largeur	Opening Apertura Ouverture	0	1	2	3	4	5	6	7	8	9	10
700021834	CE 0611	30	L / R	1039	1124	-	1265	1355	1442	-	1547	-	-	-
700021835	CE 0611	40	L / R	1059	1159	-	1313	1402	1484	-	1610	-	-	-
700021836	CE 0611	45	L / R	1077	1182	-	1343	1431	1514	-	1651	-	-	-
700021837	CE 0611	50	L / R	1092	1201	-	1369	1462	1555	-	1689	-	-	-
700021838	CE 0611	60	L / R	1141	1263	-	1447	1541	1634	-	1798	-	-	-

45 depth / profundidad / profondeur

SAP	Code Código Code	Width Ancho Largeur	Opening Apertura Ouverture	0	1	2	3	4	5	6	7	8	9	10
700021839	CE 0612	30	L / R	1003	1090	-	1228	1312	1392	-	1508	-	-	-
700021840	CE 0612	40	L / R	1029	1130	-	1281	1371	1453	-	1578	-	-	-
700021841	CE 0612	45	L / R	1045	1151	-	1309	1397	1481	-	1617	-	-	-
700021842	CE 0612	50	L / R	1057	1169	-	1333	1427	1519	-	1653	-	-	-
700021843	CE 0612	60	L / R	1082	1208	-	1385	1480	1565	-	1719	-	-	-

H. 234

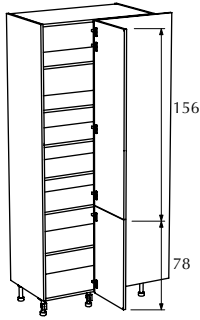

Tower straight corner unit.
2 doors.
1 fixed shelf.
5 shelves.
Unit for standard corner filler, 10x10 cm.
Order corner filler separately to insert between add-on units for 90° union.

Módulo columna rinconero recto.
2 puertas.
1 balda fija.
5 baldas.
Módulo para regletas de unión estándar, 10x10 cm.
Solicitar regleta de unión por separado.

Modules colonne encoignure droite.
2 portes.
1 étagère fixe.
5 étagères.
Module pour fileur d'encoignure standard, 10x10 cm.
Commander fileur d'union séparément.

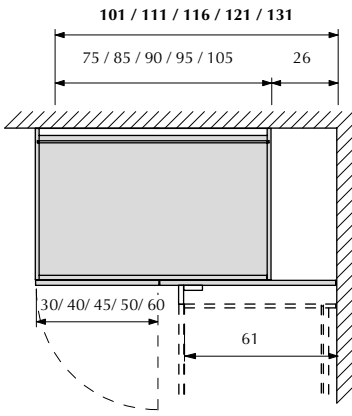

Availability / disponibilidad / disponibilité:

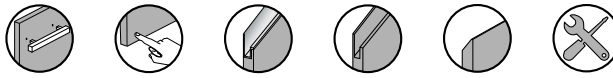

61 depth / profundidad / profondeur

SAP	Code Código Code	Width Ancho Largeur	Opening Apertura Ouverture	0	1	2	3	4	5	6	7	8	9	10
700021849	CRR 0614	101	L / R	837	1052	-	1221	1266	1338	-	1520	-	-	-
700021850	CRR 0614	111	L / R	863	1095	-	1277	1327	1406	-	1608	-	-	-
700021851	CRR 0614	116	L / R	881	1119	-	1307	1354	1438	-	1649	-	-	-
700021852	CRR 0614	121	L / R	894	1137	-	1332	1374	1463	-	1684	-	-	-
700021853	CRR 0614	131	L / R	920	1178	-	1384	1428	1524	-	1765	-	-	-

H. 234

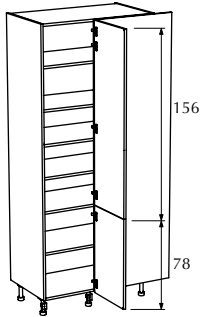

Tower straight corner unit.
2 doors.
1 fixed shelf.
5 shelves.
Unit for corner filler with raised door profile 4x4 cm.
Order corner filler separately to insert between add-on units for 90° union.

Módulo columna rinconero recto.
2 puertas.
1 balda fija.
5 baldas.
Módulo para regleta de rincón con perfil de puerta de 4x4 cm.
Solicitar regleta de unión por separado.

Modules colonne encoignure droite.
2 portes.
1 étagère fixe.
5 étagères.
Module pour fileur d'encoignure avec profilé de porte, 4x4 cm.
Commander fileur d'union séparément.

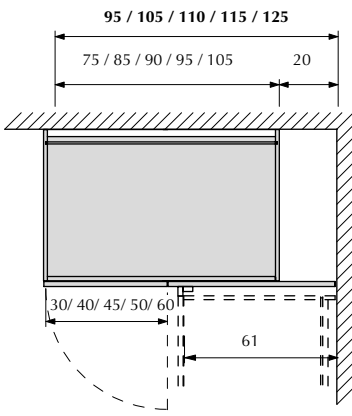

Availability / disponibilidad / disponibilité:

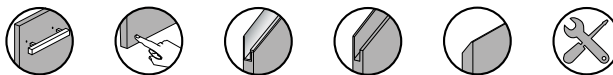

61 depth / profundidad / profondeur

SAP	Code Código Code	Width Ancho Largeur	Opening Apertura Ouverture	0	1	2	3	4	5	6	7	8	9	10
700022061	CRR 0614	95	L / R	837	1052	-	1221	1266	1338	-	1520	-	-	-
700022062	CRR 0614	105	L / R	863	1095	-	1277	1327	1406	-	1608	-	-	-
700022063	CRR 0614	110	L / R	881	1119	-	1307	1354	1438	-	1649	-	-	-
700022064	CRR 0614	115	L / R	894	1137	-	1332	1374	1463	-	1684	-	-	-
700022065	CRR 0614	125	L / R	920	1178	-	1384	1428	1524	-	1765	-	-	-

Tower units
Columnas
Colonnes

Tower broom and cleaning product unit
Módulo columna para útiles de limpieza
Modules colonne pour utensiles de nettoyage

H. 234

Tower broom and cleaning product unit.
2 doors.
1 fixed shelf.
1 shelf.

Módulo columna para útiles de limpieza.
2 puertas.
1 balda fija.
1 balda.

Colonne pour utensiles de nettoyage.
2 portes.
1 étagère fixe.
1 étagère

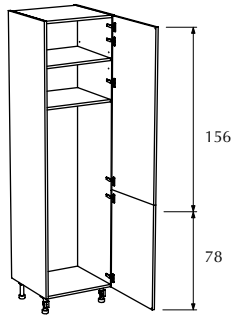

Availability / disponibilidad / disponibilité:

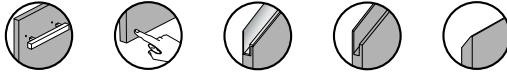

61 depth / profundidad / profondeur

SAP	Code Código Code	Width Ancho Largeur	Opening Apertura Ouverture											
				0	1	2	3	4	5	6	7	8	9	10
700021872	CUL 0619	30	L / R	598	673	-	762	809	854	-	932	-	-	-
700021873	CUL 0619	40	L / R	608	700	-	801	852	905	-	1005	-	-	-
700021874	CUL 0619	45	L / R	620	718	-	825	875	929	-	1040	-	-	-
700021875	CUL 0619	50	L / R	629	732	-	845	892	949	-	1071	-	-	-
700021876	CUL 0619	60	L / R	662	779	-	905	960	1018	-	1141	-	-	-

45 depth / profundidad / profondeur

SAP	Code Código Code	Width Ancho Largeur	Opening Apertura Ouverture											
				0	1	2	3	4	5	6	7	8	9	10
700021877	CUL 0620	30	L / R	551	628	-	713	766	819	-	899	-	-	-
700021878	CUL 0620	40	L / R	566	661	-	758	808	861	-	961	-	-	-
700021879	CUL 0620	45	L / R	577	677	-	780	837	884	-	976	-	-	-
700021880	CUL 0620	50	L / R	585	690	-	799	854	903	-	1006	-	-	-
700021881	CUL 0620	60	L / R	601	720	-	841	894	954	-	1076	-	-	-

35 depth / profundidad / profondeur

SAP	Code Código Code	Width Ancho Largeur	Opening Apertura Ouverture											
				0	1	2	3	4	5	6	7	8	9	10
700021882	CUL 0621	30	L / R	512	591	-	672	718	764	-	841	-	-	-
700021883	CUL 0621	40	L / R	531	627	-	721	772	825	-	924	-	-	-
700021884	CUL 0621	45	L / R	542	643	-	743	792	847	-	956	-	-	-
700021885	CUL 0621	50	L / R	548	655	-	761	807	865	-	976	-	-	-
700021886	CUL 0621	60	L / R	562	683	-	800	853	913	-	1045	-	-	-

H. 234

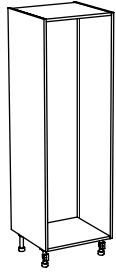

Carcass for tower unit kit for oven and microwave.

Comments:
Must be filled with units for oven and microwave tower unit kit.
See instructions on chapter 01.

Casco para kit columna de horno y microondas.

Observaciones:
Se debe completar con módulos para kit columna horno y microondas.
Ver instrucciones en capítulos 01.

Caisson pour kit colonne pour four et micro-ondes.

Remarques:
Doit être complétés avec les modules pour kit colonne four et micro-ondes.
Voir instructions en chapitre 01.

Availability / disponibilidad / disponibilité:



61 depth / profundidad / profondeur				
SAP	Code Código Code	Width Ancho Largeur	Opening Apertura Ouverture	Carcass colour Color de casco Couleur de caisson
700021910	CHM 0628	60	-	425
700021911	CHM 0628	68,6	-	429
700021912	CHM 0628	76,2	-	433
700021913	CHM 0628	90	-	441
700021914	CHM 0628	91,5	-	441

H. 234

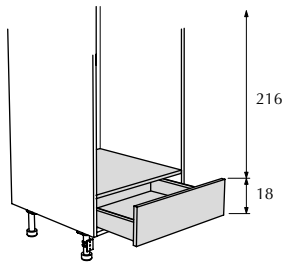

Lower unit with drawers for kit for oven and microwave.
1 drawer.
1 top shelf.
1 back panel.
H 18

Módulo inferior con cajones para kit columna de horno y microondas.
1 cajón.
1 techo.
1 trasera.
H 18

Module inférieur avec tiroirs pour four et micro-ondes.
1 tiroir.
1 joue supérieure.
1 panneau arrière.
H 18

Availability / disponibilidad / disponibilité:

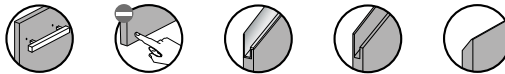

61 depth / profundidad / profondeur														
SAP	Code Código Code	Width Ancho Largeur	Opening Apertura Ouverture	0	1	2	3	4	5	6	7	8	9	10
700021915	CHM 0629	60	-	285	308	-	353	376	387	-	407	-	-	-
700021916	CHM 0629	68,6	-	295	318	-	365	391	402	-	421	-	-	-
700021917	CHM 0629	76,2	-	303	327	-	376	403	413	-	433	-	-	-
700021918	CHM 0629	90	-	312	338	-	389	415	426	-	448	-	-	-
700021919	CHM 0629	91,5	-	313	339	-	390	418	431	-	450	-	-	-

H. 234

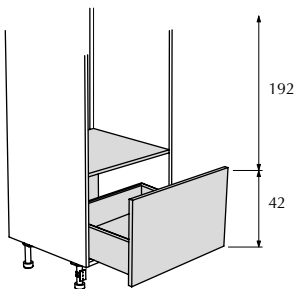

Lower unit with drawers for kit for oven and microwave.
1 deep drawer.
1 top shelf.
1 back panel.
H 42

Módulo inferior con cajones para kit columna de horno y microondas.
1 gaveta.
1 techo.
1 trasera.
H 42

Module inférieur avec tiroirs pour four et micro-ondes.
1 extractible.
1 joue supérieure.
1 panneau arrière.
H 42

Availability / disponibilidad / disponibilité:

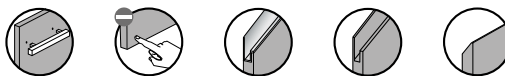

61 depth / profundidad / profondeur														
SAP	Code Código Code	Width Ancho Largeur	Opening Apertura Ouverture	0	1	2	3	4	5	6	7	8	9	10
700021920	CHM 0630	60	-	332	361	-	407	435	455	-	486	-	-	-
700021921	CHM 0630	68,6	-	342	372	-	421	450	469	-	504	-	-	-
700021922	CHM 0630	76,2	-	353	388	-	440	470	492	-	530	-	-	-
700021923	CHM 0630	90	-	363	400	-	455	484	504	-	542	-	-	-
700021924	CHM 0630	91,5	-	364	401	-	457	488	508	-	544	-	-	-

H. 234

Lower unit with door for kit for oven and microwave.
1 door.
1 shelf.
1 top shelf.
1 back panel.
H 60

Módulo inferior con puerta para kit columna de horno y microondas.
1 puerta.
1 balda.
1 techo.
1 trasera.
H 60

Module inférieur avec porte pour four et micro-ondes.
1 porte.
1 étagère.
1 joue supérieure.
1 panneau arrière.
H 60

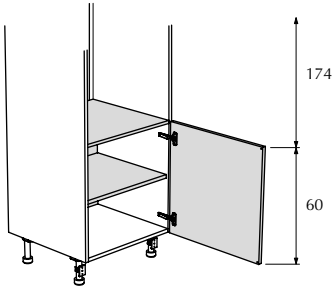

Availability / disponibilidad / disponibilité:

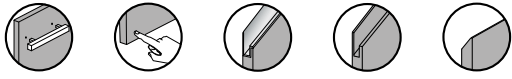

61 depth / profundidad / profondeur

SAP	Code Código Code	Width Ancho Largeur	Opening Apertura Ouverture											
				0	1	2	3	4	5	6	7	8	9	10
700021925	CHM 0631	60	-	172	216	-	257	278	297	-	329	-	-	-
700021926	CHM 0631	68,6	-	178	224	-	268	291	314	-	351	-	-	-
700021927	CHM 0631	76,2	-	183	231	-	273	301	324	-	358	-	-	-

H. 234

Lower unit with drawers for kit for oven and microwave.
1 deep drawer.
1 top shelf.
1 back panel.
H 60

Módulo inferior con cajones para kit columna de horno y microondas.
1 gaveta.
1 techo.
1 trasera.
H 60

Module inférieur avec tiroirs pour four et micro-ondes.
1 extractible.
1 joue supérieure.
1 panneau arrière.
H 60

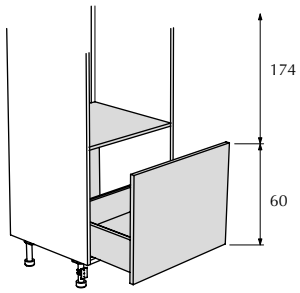

Availability / disponibilidad / disponibilité:

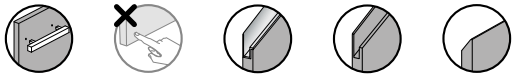

61 depth / profundidad / profondeur

SAP	Code Código Code	Width Ancho Largeur	Opening Apertura Ouverture											
				0	1	2	3	4	5	6	7	8	9	10
700021928	CHM 0632	60	-	338	375	-	423	452	475	-	511	-	-	-
700021929	CHM 0632	68,6	-	348	388	-	439	469	491	-	527	-	-	-
700021930	CHM 0632	76,2	-	357	398	-	453	483	505	-	545	-	-	-
700021931	CHM 0632	90	-	367	412	-	471	507	529	-	566	-	-	-
700021932	CHM 0632	91,5	-	368	414	-	473	509	531	-	569	-	-	-

H. 234

Lower unit with drawers for kit for oven and microwave.
1 drawer.
1 deep drawer.
1 top shelf.
1 back panel.
H 60

Módulo inferior con cajones para kit columna de horno y microondas.
1 cajón.
1 gaveta.
1 techo.
1 trasera.
H 60

Module inférieur avec tiroirs pour four et micro-ondes.
1 tiroir.
1 extractible.
1 joue supérieure.
1 panneau arrière.
H 60

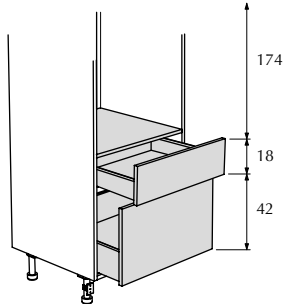

Availability / disponibilidad / disponibilité:



61 depth / profundidad / profondeur

SAP	Code Código Code	Width Ancho Largeur	Opening Apertura Ouverture											
				0	1	2	3	4	5	6	7	8	9	10
700021933	CHM 0633	60	-	504	560	-	637	692	725	-	771	-	-	-
700021934	CHM 0633	68,6	-	521	579	-	660	721	748	-	792	-	-	-
700021935	CHM 0633	76,2	-	536	599	-	691	746	776	-	817	-	-	-
700021936	CHM 0633	90	-	551	618	-	702	768	801	-	850	-	-	-
700021937	CHM 0633	91,5	-	552	620	-	705	770	804	-	853	-	-	-

H. 234

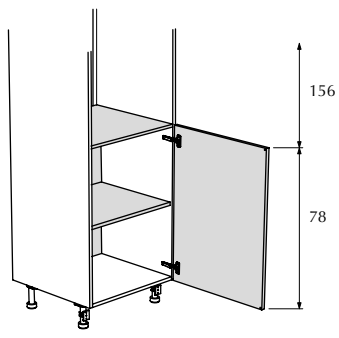

Lower unit with door for kit for oven and microwave.
1 door.
1 shelf.
1 top shelf.
1 back panel.
H 78

Módulo inferior con puerta para kit columna de horno y microondas.
1 puerta.
1 balda.
1 techo.
1 trasera.
H 78

Module inférieur avec porte pour four et micro-ondes.
1 porte.
1 étagère.
1 joue supérieure.
1 panneau arrière.
H 78

Availability / disponibilidad / disponibilité:

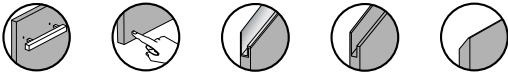

61 depth / profundidad / profondeur

SAP	Code Código Code	Width Ancho Largeur	Opening Apertura Ouverture											
				0	1	2	3	4	5	6	7	8	9	10
700021938	CHM 0634	60	-	175	225	-	263	288	311	-	352	-	-	-
700021939	CHM 0634	68,6	-	181	234	-	276	301	327	-	371	-	-	-
700021940	CHM 0634	76,2	-	187	242	-	287	312	339	-	388	-	-	-

H. 234

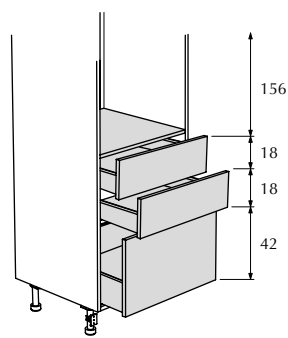

Lower unit with drawers for kit for oven and microwave.
2 drawers.
1 deep drawer.
1 top shelf.
1 back panel.
H 78

Módulo inferior con cajones para kit columna de horno y microondas.
2 cajones.
1 gaveta.
1 techo.
1 trasera.
H 78

Module inférieur avec tiroirs pour four et micro-ondes.
2 tiroirs.
1 extractible.
1 joue supérieure.
1 panneau arrière.
H 78

Availability / disponibilidad / disponibilité:

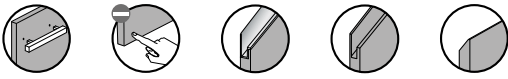

61 depth / profundidad / profondeur

SAP	Code Código Code	Width Ancho Largeur	Opening Apertura Ouverture											
				0	1	2	3	4	5	6	7	8	9	10
700021941	CHM 0635	60	-	674	758	-	853	931	974	-	1043	-	-	-
700021942	CHM 0635	68,6	-	697	784	-	884	971	1024	-	1092	-	-	-
700021943	CHM 0635	76,2	-	718	811	-	916	1005	1051	-	1124	-	-	-
700021944	CHM 0635	90	-	740	839	-	951	1036	1077	-	1159	-	-	-
700021945	CHM 0635	91,5	-	743	841	-	955	1046	1100	-	1186	-	-	-

H. 234

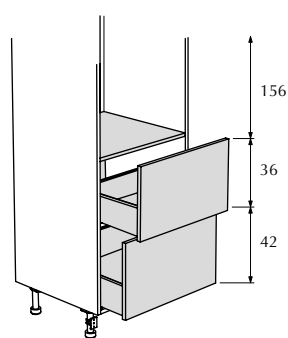

Lower unit with drawers for kit for oven and microwave.
2 deep drawers.
1 top shelf.
1 back panel.
H 78

Módulo inferior con cajones para kit columna de horno y microondas.
2 gavetas.
1 techo.
1 trasera.
H 78

Module inférieur avec tiroirs pour four et micro-ondes.
2 extractibles.
1 joue supérieure.
1 panneau arrière.
H 78

Availability / disponibilidad / disponibilité:

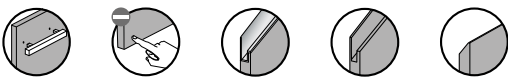

61 depth / profundidad / profondeur

SAP	Code Código Code	Width Ancho Largeur	Opening Apertura Ouverture											
				0	1	2	3	4	5	6	7	8	9	10
700021946	CHM 0636	60	-	550	610	-	690	764	826	-	901	-	-	-
700021947	CHM 0636	68,6	-	567	630	-	735	800	852	-	934	-	-	-
700021948	CHM 0636	76,2	-	582	651	-	761	824	874	-	952	-	-	-
700021949	CHM 0636	90	-	599	676	-	794	855	906	-	1004	-	-	-
700021950	CHM 0636	91,5	-	601	678	-	797	864	917	-	1008	-	-	-

H. 234

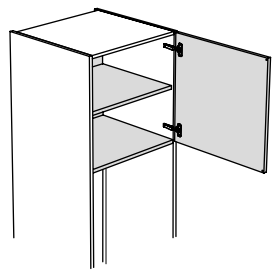

Upper unit with door for kit for oven and microwave.
1 door.
1 Shelf.
1 base shelf.
1 back panel.
Variable height.
Minimum height, 30 cm.

Módulo superior con puerta para kit columna de horno y microondas.
1 puerta.
1 balda.
1 base.
1 trasera.
Altura variable.
Altura mínima, 30 cm.

Modules supérieur avec porte pour four et micro-ondes.
1 porte.
1 étagère.
1 joue inférieure.
1 panneau arrière.
Hauteur variable.
Hauteur minimale de 30 cm.

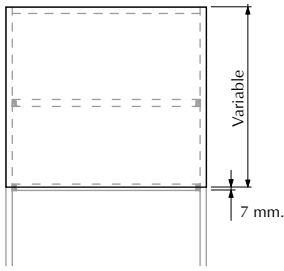

Availability / disponibilidad / disponibilité:

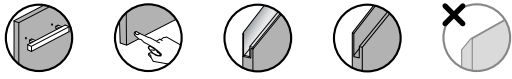

61 depth / profundidad / profondeur

SAP	Code Código Code	Width Ancho Largeur	Opening Apertura Ouverture											
				0	1	2	3	4	5	6	7	8	9	10
700021951	CHM 0637	60	-	177	230	-	273	300	327	-	368	-	-	-
700021952	CHM 0637	68,6	-	184	244	-	290	320	352	-	400	-	-	-
700021953	CHM 0637	76,2	-	191	254	-	304	335	367	-	420	-	-	-

H. 234

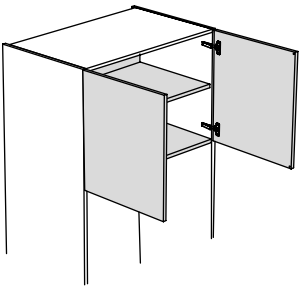

Upper unit with door for kit for oven and microwave.
2 doors.
1 Shelf.
1 base shelf.
1 back panel.
Variable height.
Minimum height, 30 cm.

Módulo superior con puerta para kit columna de horno y microondas.
2 puertas.
1 balda.
1 base.
1 trasera.
Altura variable.
Altura mínima, 30 cm.

Modules supérieur avec porte pour four et micro-ondes.
2 portes.
1 étagère.
1 joue inférieure.
1 panneau arrière.
Hauteur variable.
Hauteur minimale de 30 cm.

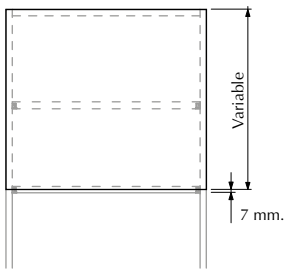

Availability / disponibilidad / disponibilité:

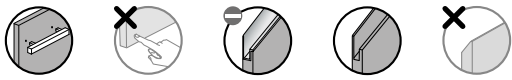

61 depth / profundidad / profondeur

SAP	Code Código Code	Width Ancho Largeur	Opening Apertura Ouverture											
				0	1	2	3	4	5	6	7	8	9	10
700021954	CHM 0638	76,2	-	207	299	-	367	409	457	-	518	-	-	-
700021955	CHM 0638	90	-	217	315	-	379	425	476	-	542	-	-	-
700021956	CHM 0638	91,5	-	218	325	-	397	450	498	-	576	-	-	-

H. 234

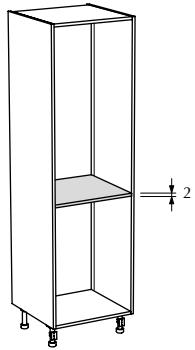

Shelf for kit for oven and microwave.
1 shelf.
H 2

Balda para kit columna de horno y microondas.
1 balda.
H 2

Étagère pour four et micro-ondes.
1 étagère.
H 2

61 depth / profundidad / profondeur

SAP	Code Código Code	Width Ancho Largeur	Opening Apertura Ouverture	Carcass colour
				Color de casco Couleur de caisson
700021957	CHM 0639	60	-	66
700021958	CHM 0639	68,6	-	69
700021959	CHM 0639	76,2	-	71
700021960	CHM 0639	90	-	74
700021961	CHM 0639	91,5	-	74

Tower units
Columnas
Colonnes

Tower unit for fridge
Módulo columna para frigorífico
Module colonne pour réfrigérateur

H. 234

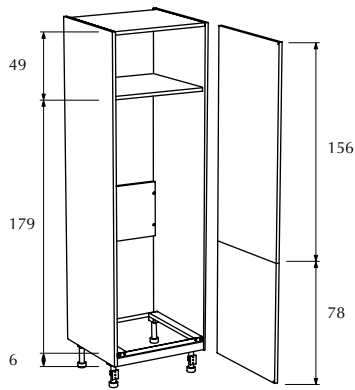

Tower unit for fridge.
2 doors.
1 structure with ventilation grille.
1 shelf.
1 back panel.
WITHOUT hinges.

Columna de frigorífico.
2 puertas.
1 estructura con rejilla de ventilación.
1 balda.
1 trasera.
SIN bisagras.

Colonne réfrigérateur.
2 portes.
1 structure avec grille d'aération.
1 étagère.
1 panneau arrière.
SANS charnières.

Availability / disponibilidad / disponibilité:

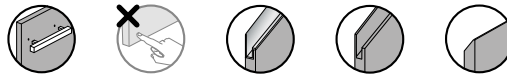

61 depth / profundidad / profondeur

SAP	Code Código Code	Width Ancho Largeur	Opening Apertura Ouverture	0	1	2	3	4	5	6	7	8	9	10
				700021984	CFS 0663	60	-	659	776	-	901	956	1023	-

H. 234

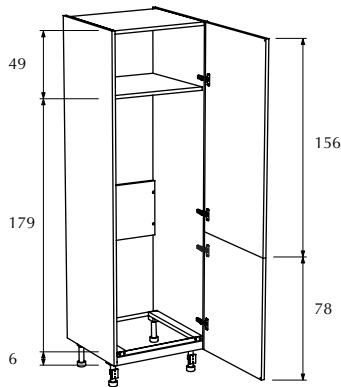

Tower unit for fridge.
2 doors.
1 structure with ventilation grille.
1 shelf.
1 back panel.
WITH hinges.

Columna de frigorífico.
2 puertas.
1 estructura con rejilla de ventilación.
1 balda.
1 trasera.
CON bisagras.

Colonne réfrigérateur.
2 portes.
1 structure avec grille d'aération.
1 étagère.
1 panneau arrière.
AVEC charnières.

Availability / disponibilidad / disponibilité:

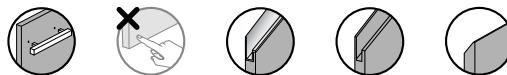

61 depth / profundidad / profondeur

SAP	Code Código Code	Width Ancho Largeur	Opening Apertura Ouverture	0	1	2	3	4	5	6	7	8	9	10
				700021985	CF 0664	60	L / R	659	776	-	901	956	1023	-

Tower units
Columnas
Colonnes

Tower unit for fridge
Módulo columna para frigorífico
Module colonne pour réfrigérateur

H. 234

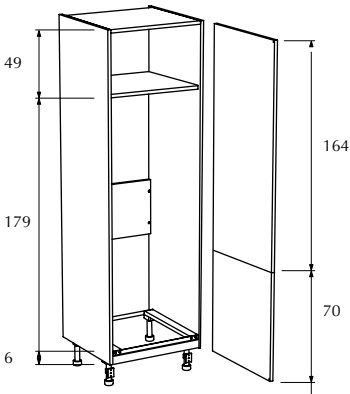

Tower unit for fridge.
2 doors.
1 structure with ventilation grille.
1 shelf.
1 back panel.
WITHOUT hinges.

Columna de frigorífico.
2 puertas.
1 estructura con rejilla de ventilación.
1 balda.
1 trasera.
SIN bisagras.

Colonne réfrigérateur.
2 portes.
1 structure avec grille d'aération.
1 étagère.
1 panneau arrière.
SANS charnières.

Availability / disponibilidad / disponibilité:

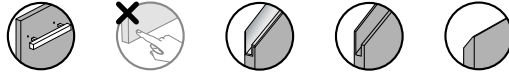

61 depth / profundidad / profondeur

SAP	Code Código Code	Width Ancho Largeur	Opening Apertura Ouverture	0	1	2	3	4	5	6	7	8	9	10
				700021986	CFS 0665	60	-	659	776	-	901	956	1023	-

H. 234

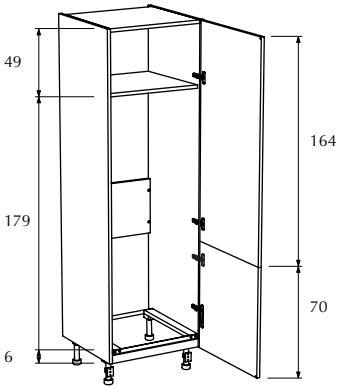

Tower unit for fridge.
2 doors.
1 structure with ventilation grille.
1 shelf.
1 back panel.
WITH hinges.

Columna de frigorífico.
2 puertas.
1 estructura con rejilla de ventilación.
1 balda.
1 trasera.
CON bisagras.

Colonne réfrigérateur.
2 portes.
1 structure avec grille d'aération.
1 étagère.
1 panneau arrière.
AVEC charnières.

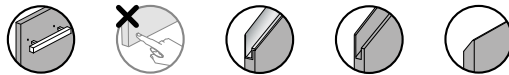

Availability / disponibilidad / disponibilité:



61 depth / profundidad / profondeur

SAP	Code Código Code	Width Ancho Largeur	Opening Apertura Ouverture	0	1	2	3	4	5	6	7	8	9	10
				700021987	CF 0666	60	L / R	659	776	-	901	956	1023	-

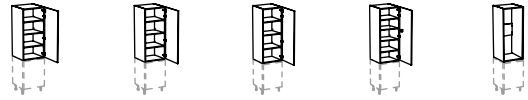
Stackable units
Módulos apilables
Modules superposables

Type of unit Tipo de módulo Type de module	Available measures Medidas disponibles Dimensions disponibles	Available units Módulos disponibles Modules disponibles
p.166 - 167 Stackable units Módulos apilables Modules superposables	Depth / Profundidad / Profondeur (cm.): 61 Width / Ancho / Largeur (cm.): 30 - 40 - 45 - 50 - 60	 CAP 0667 h.120 CAP 0668 h.132 CAP 0669 h.144 CAP 0670 h.156 CAP 0671 Variable
p.168 - 169 Liva unit Módulo Liva Module Liva	Depth / Profundidad / Profondeur (cm.): 61 Width / Ancho / Largeur (cm.): 60	 CAP 0672 h.120 CAP 0673 h.132 CAP 0674 h.144 CAP 0675 h.156 RK 0676

H. 198

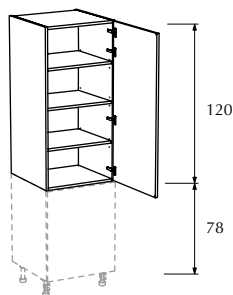

Stackable unit with door.
1 door.
3 shelves.
H 120

Módulo apilable con puerta.
1 puerta.
3 baldas.
H 120

Module superposable avec porte.
1 porte.
3 étagères.
H 120

Availability / disponibilidad / disponibilité:

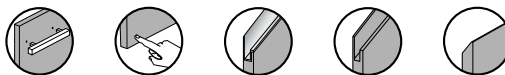

61 depth / profundidad / profondeur

SAP	Code Código Code	Width Ancho Largeur	Opening Apertura Ouverture	0	1	2	3	4	5	6	7	8	9	10
700021988	CAP 0667	30	L / R	478	510	-	571	599	630	-	675	-	-	-
700021989	CAP 0667	40	L / R	497	534	-	602	627	650	-	705	-	-	-
700021990	CAP 0667	45	L / R	507	547	-	618	642	666	-	727	-	-	-
700021991	CAP 0667	50	L / R	515	557	-	632	661	693	-	746	-	-	-
700021992	CAP 0667	60	L / R	545	596	-	678	708	734	-	797	-	-	-

H. 210

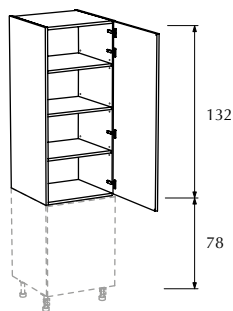

Stackable unit with door.
1 door.
3 shelves.
H 132

Módulo apilable con puerta.
1 puerta.
3 baldas.
H 132

Module superposable avec porte.
1 porte.
3 étagères.
H 132

Availability / disponibilidad / disponibilité:

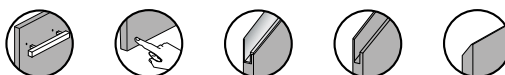

61 depth / profundidad / profondeur

SAP	Code Código Code	Width Ancho Largeur	Opening Apertura Ouverture	0	1	2	3	4	5	6	7	8	9	10
700021993	CAP 0668	30	L / R	486	520	-	582	610	642	-	690	-	-	-
700021994	CAP 0668	40	L / R	501	541	-	611	641	672	-	732	-	-	-
700021995	CAP 0668	45	L / R	509	552	-	625	654	683	-	739	-	-	-
700021996	CAP 0668	50	L / R	519	567	-	645	675	701	-	766	-	-	-
700021997	CAP 0668	60	L / R	548	602	-	688	716	745	-	814	-	-	-

H. 222

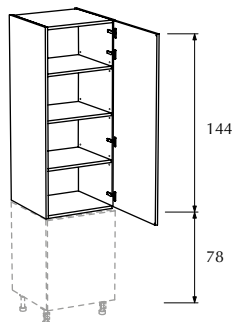

Stackable unit with door.
1 door.
3 shelves.
H 144

Módulo apilable con puerta.
1 puerta.
3 baldas.
H 144

Module superposable avec porte.
1 porte.
3 étagères.
H 144

Availability / disponibilidad / disponibilité:

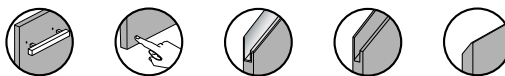

61 depth / profundidad / profondeur

SAP	Code Código Code	Width Ancho Largeur	Opening Apertura Ouverture	0	1	2	3	4	5	6	7	8	9	10
700021998	CAP 0669	30	L / R	493	529	-	594	626	655	-	706	-	-	-
700021999	CAP 0669	40	L / R	509	551	-	624	652	679	-	737	-	-	-
700022000	CAP 0669	45	L / R	519	567	-	644	674	701	-	757	-	-	-
700022001	CAP 0669	50	L / R	527	579	-	659	688	716	-	786	-	-	-
700022002	CAP 0669	60	L / R	557	614	-	704	736	768	-	836	-	-	-

Tower units
Columnas
Colonnes

Stackable units
Módulos apilables
Modules superposables

H. 234

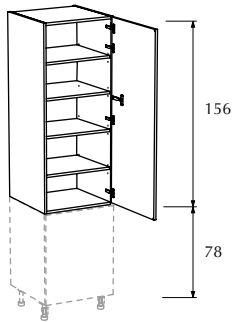

Stackable unit with door.
1 door.
4 shelves.
H 156

Módulo apilable con puerta.
1 puerta.
4 baldas.
H 156

Module superposable avec porte.
1 porte.
4 étagères.
H 156

Availability / disponibilidad / disponibilité:

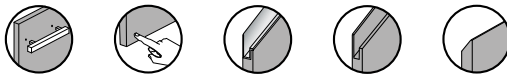

61 depth / profundidad / profondeur

SAP	Code Código Code	Width Ancho Largeur	Opening Apertura Ouverture											
				0	1	2	3	4	5	6	7	8	9	10
700022003	CAP 0670	30	L / R	531	567	-	638	669	699	-	748	-	-	-
700022004	CAP 0670	40	L / R	550	596	-	675	705	731	-	786	-	-	-
700022005	CAP 0670	45	L / R	561	610	-	694	722	750	-	812	-	-	-
700022006	CAP 0670	50	L / R	570	623	-	711	737	767	-	835	-	-	-
700022007	CAP 0670	60	L / R	605	668	-	765	792	830	-	929	-	-	-

H. 198 / 206 / 222 / 234

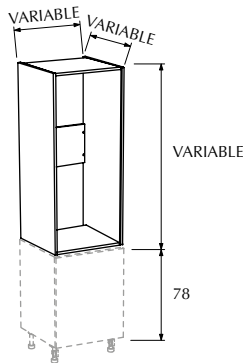

Stackable unit without door.
Maximum dimensions, 216 x 120 x 75 cm
(height x width x depth).

Módulo apilable sin puerta.
Medidas máximas, 216 x 120 x 75 cm (alto
x ancho x profundo).

Module superposable sans porte.
Dimensions maximales, 216 x 120 x 75 cm
(Hauteur x largeur x profondeur).

Availability / disponibilidad / disponibilité:



61 depth / profundidad / profondeur

SAP	Code Código Code	Width Ancho Largeur	Opening Apertura Ouverture	Carcass colour Color de casco Couleur de caisson
700022008	CAP 0671	-	-	496

Tower units
Columnas
Colonnes

Stackable units
Módulos apilables
Modules superposables

Liva unit
Módulo Liva
Module Liva

H. 198

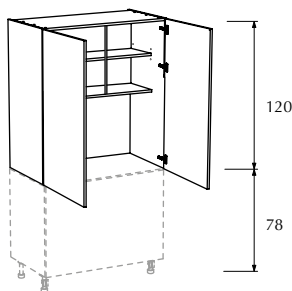

Liva unit.
2 doors.
2 reduced-depth shelves.
Without base panel.
H 120

Módulo Liva.
2 puertas.
2 baldas de fondo reducido.
Sin base.
H 120

Module Liva.
2 portes.
2 étagères à profondeur réduite.
Sans panneau de base.
H 120

Availability / disponibilidad / disponibilité:

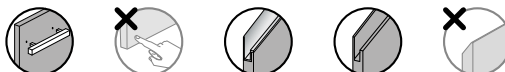

61 depth / profundidad / profondeur

SAP	Code Código Code	Width Ancho Largeur	Opening Apertura Ouverture	0	1	2	3	4	5	6	7	8	9	10
700022069	CAP 0672	120	-	664	782	-	910	962	1022	-	1148	-	-	-

H. 210

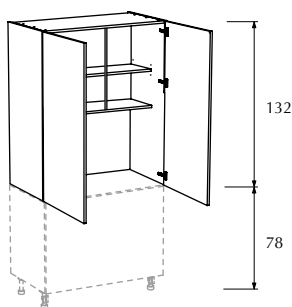

Liva unit.
2 doors.
2 reduced-depth shelves.
Without base panel.
H 132

Módulo Liva.
2 puertas.
2 baldas de fondo reducido.
Sin base.
H 132

Module Liva.
2 portes.
2 étagères à profondeur réduite.
Sans panneau de base.
H 132

Availability / disponibilidad / disponibilité:

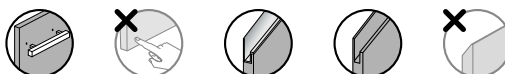

61 depth / profundidad / profondeur

SAP	Code Código Code	Width Ancho Largeur	Opening Apertura Ouverture	0	1	2	3	4	5	6	7	8	9	10
700022070	CAP 0673	120	-	677	803	-	938	985	1050	-	1189	-	-	-

H. 222

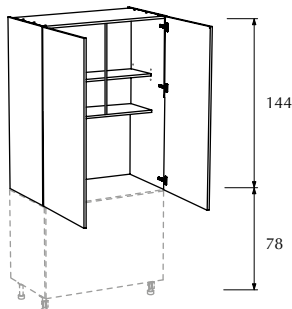

Liva unit.
2 doors.
2 reduced-depth shelves.
Without base panel.
H 144

Módulo Liva.
2 puertas.
2 baldas de fondo reducido.
Sin base.
H 144

Module Liva.
2 portes.
2 étagères à profondeur réduite.
Sans panneau de base.
H 144

Availability / disponibilidad / disponibilité:

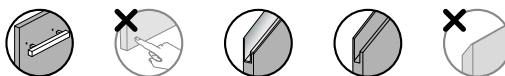

61 depth / profundidad / profondeur

SAP	Code Código Code	Width Ancho Largeur	Opening Apertura Ouverture	0	1	2	3	4	5	6	7	8	9	10
700022071	CAP 0674	120	-	689	821	-	964	1015	1077	-	1228	-	-	-

H. 234

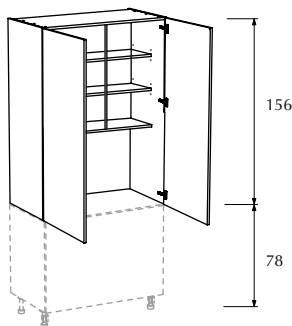

Liva unit.
2 doors.
3 reduced-depth shelves.
Without base panel.
H 156

Módulo Liva.
2 puertas.
3 baldas de fondo reducido.
Sin base.
H 156

Module Liva.
2 portes.
3 étagères à profondeur réduite.
Sans panneau de base.
H 156

Availability / disponibilidad / disponibilité:

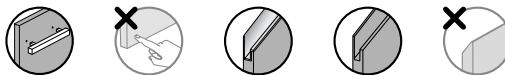

61 depth / profundidad / profondeur

SAP	Code Código Code	Width Ancho Largeur	Opening Apertura Ouverture	0	1	2	3	4	5	6	7	8	9	10
700022072	CAP 0675	120	-	776	919	-	1077	1133	1206	-	1370	-	-	-

Tower units
Columnas
Colonnes

Stackable units
Módulos apilables
Modules superposables

Krion® paneling for Liva unit.
White Krion® finish.
12 mm thick.

Revestimiento de Krion® para módulo Liva
Acabado en Krion® blanco.
12 mm. de espesor.

Revêtement en Krion® pour module Liva.
Finition en Krion® blanc.
12 mm d'épaisseur.

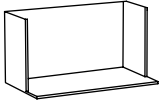

61 depth / profundidad / profondeur

SAP	Code Código Code	Width Ancho Largeur	Opening Apertura Ouverture	Krion®
700022073	RK 0676	120	-	1682

Complements for tower unit
Complementos para módulo columna
Compléments pour module colonne

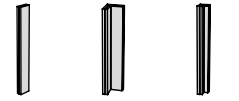
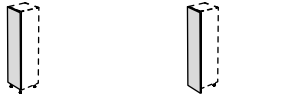
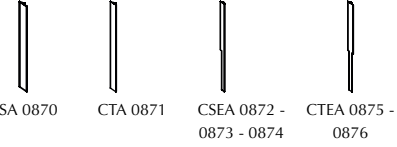
Type of unit Tipo de módulo Type de module	Available measures Medidas disponibles Dimensions disponibles	Available units Módulos disponibles Modules disponibles
<p>p.172 Fillers Regletas Fileursne</p>	Height / Altura / Hauteur (cm.): 120 - 132 - 144 - 150 - 156 - 198 - 210 - 222 - 234	 <p>BRE 0850 BRE 0854 BRE 0855</p>
<p>p.173 - 174 Decorative side panels Paneles decorativos Panneaux décoratifs</p>	Depth / Profundidad / Profondeur (cm.): 35 - 45 - 61 Height / Altura / Hauteur (cm.): (CPD) 120-132-144-150-156-198-210-222-234 (CCA) 160-162-208-210-220-222-232-234-244-246	 <p>BPD 0857 - 0858 - 0859 BCA 0860- 0861 - 0862 - 0863 - 0864 - 0865</p>
<p>p.175 - 176 Comp. for models with integrated handle Comp. para modelos con tirador integrado Comp. pour modèles avec poignée intégrée</p>		 <p>CSA 0870 CTA 0871 CSEA 0872 - 0873 - 0874 CTEA 0875 - 0876</p>

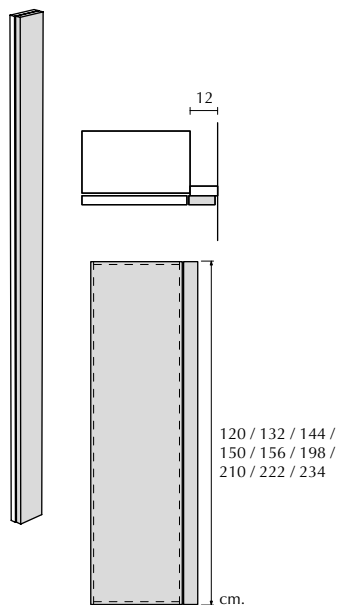

Front filler piece.
Plain design.
Width, 12 cm.

Regleta de ajuste.
Diseño liso.
Ancho, 12 cm.

Fileur d'ajustement.
Modèle lisse.
Largeur, 12 cm.

12 width / ancho / largeur

SAP	Code Código Code	Height Altura Hauteur	Position Posición Position	12 width / ancho / largeur										
				0	1	2	3	4	5	6	7	8	9	10
700022090	CRE 0850	120	-	-	87	-	100	-	113	-	-	-	-	-
700022091	CRE 0850	132	-	-	89	-	103	-	117	-	-	-	-	-
700022092	CRE 0850	144	-	-	91	-	107	-	122	-	-	-	-	-
700022093	CRE 0850	150	-	-	93	-	108	-	124	-	-	-	-	-
700022094	CRE 0850	156	-	-	94	-	110	-	126	-	-	-	-	-
700022095	CRE 0850	198	-	-	102	-	121	-	142	-	-	-	-	-
700022096	CRE 0850	210	-	-	105	-	124	-	147	-	-	-	-	-
700022097	CRE 0850	222	-	-	107	-	128	-	151	-	-	-	-	-
700022098	CRE 0850	234	-	-	110	-	131	-	156	-	-	-	-	-

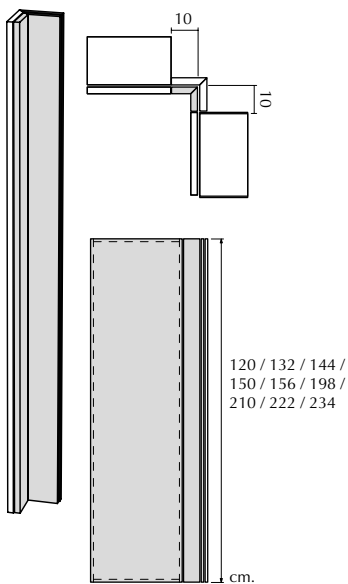

Corner filler piece for 90° solution.
Plain design.
Distance between units, 10x10 cm.

Regleta de rincón, ángulo 90°.
Diseño liso.
Distancia entre módulos, 10x10 cm.

Fileur d'encoignure, angle 90°.
Modèle lisse.
Distance entre modules, 10x10 cm.

12 width / ancho / largeur

SAP	Code Código Code	Height Altura Hauteur	Position Posición Position	12 width / ancho / largeur										
				0	1	2	3	4	5	6	7	8	9	10
700022134	CRE 0854	120	-	-	139	-	166	-	198	-	-	-	-	-
700022136	CRE 0854	132	-	-	144	-	173	-	208	-	-	-	-	-
700022137	CRE 0854	144	-	-	149	-	180	-	218	-	-	-	-	-
700022138	CRE 0854	150	-	-	152	-	183	-	223	-	-	-	-	-
700022139	CRE 0854	156	-	-	154	-	187	-	228	-	-	-	-	-
700022140	CRE 0854	198	-	-	171	-	210	-	262	-	-	-	-	-
700022141	CRE 0854	210	-	-	178	-	219	-	274	-	-	-	-	-
700022142	CRE 0854	222	-	-	183	-	226	-	284	-	-	-	-	-
700022143	CRE 0854	234	-	-	188	-	233	-	294	-	-	-	-	-

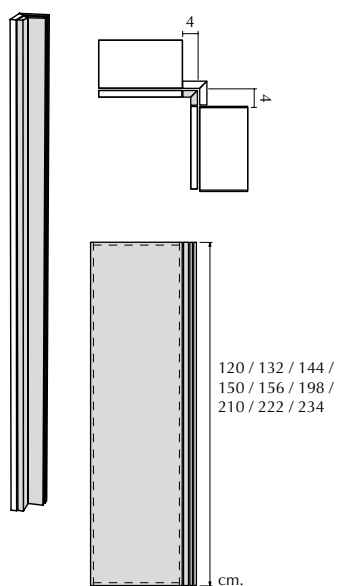

Corner filler piece for 90° solution.
Plain design.
Distance between units, 4x4 cm.

Regleta de rincón, ángulo 90°.
Diseño liso.
Distancia entre módulos, 4x4 cm.

Fileur d'encoignure, angle 90°.
Modèle lisse.
Distance entre modules, 4x4 cm.

12 width / ancho / largeur

SAP	Code Código Code	Height Altura Hauteur	Position Posición Position	12 width / ancho / largeur										
				0	1	2	3	4	5	6	7	8	9	10
700022159	CRE 0855	120	-	-	139	-	166	-	214	-	-	-	-	-
700022161	CRE 0855	132	-	-	145	-	173	-	208	-	-	-	-	-
700022162	CRE 0855	144	-	-	150	-	181	-	219	-	-	-	-	-
700022163	CRE 0855	150	-	-	153	-	185	-	224	-	-	-	-	-
700022164	CRE 0855	156	-	-	156	-	188	-	229	-	-	-	-	-
700022165	CRE 0855	198	-	-	171	-	210	-	262	-	-	-	-	-
700022166	CRE 0855	210	-	-	178	-	219	-	274	-	-	-	-	-
700022167	CRE 0855	222	-	-	183	-	226	-	284	-	-	-	-	-
700022168	CRE 0855	234	-	-	188	-	233	-	295	-	-	-	-	-

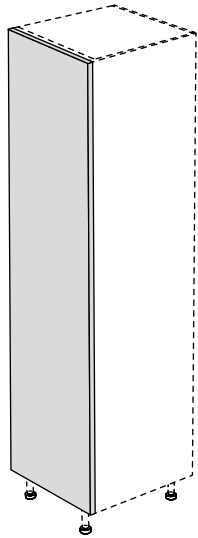

Decorative side panel.
Panel thickness, 19 mm.
On level with front.

Panel decorativo.
Espesor de panel, 19 mm.
A ras de frente.

Panneau décoratif.
Épaisseur du panneau, 19 mm.
Au ras de façade.

61 depth / profundidad / profondeur

SAP	Height Altura Hauteur	R1		R2		R3	
		700022187	120	CPDL 0857	71	CPDR 0857	113
700022189	132	CPDL 0857	75	CPDR 0857	121	CPDE 0857	188
700022190	144	CPDL 0857	81	CPDR 0857	132	CPDE 0857	205
700022191	150	CPDL 0857	83	CPDR 0857	136	CPDE 0857	212
700022192	156	CPDL 0857	85	CPDR 0857	140	CPDE 0857	219
700022193	198	CPDL 0857	99	CPDR 0857	167	CPDE 0857	268
700022194	210	CPDL 0857	103	CPDR 0857	175	CPDE 0857	282
700022195	222	CPDL 0857	107	CPDR 0857	183	CPDE 0857	296
700022196	234	CPDL 0857	111	CPDR 0857	190	CPDE 0857	310

45 depth / profundidad / profondeur

SAP	Height Altura Hauteur	R1		R2		R3	
		700022212	120	CPDL 0858	59	CPDR 0858	92
700022214	132	CPDL 0858	64	CPDR 0858	100	CPDE 0858	150
700022215	144	CPDL 0858	67	CPDR 0858	106	CPDE 0858	160
700022216	150	CPDL 0858	69	CPDR 0858	109	CPDE 0858	166
700022217	156	CPDL 0858	70	CPDR 0858	112	CPDE 0858	171
700022218	198	CPDL 0858	84	CPDR 0858	136	CPDE 0858	211
700022219	210	CPDL 0858	87	CPDR 0858	142	CPDE 0858	222
700022220	222	CPDL 0858	90	CPDR 0858	148	CPDE 0858	232
700022221	234	CPDL 0858	93	CPDR 0858	154	CPDE 0858	243

35 depth / profundidad / profondeur

SAP	Height Altura Hauteur	R1		R2		R3	
		700022237	120	CPDL 0859	53	CPDR 0859	80
700022239	132	CPDL 0859	56	CPDR 0859	85	CPDE 0859	124
700022240	144	CPDL 0859	58	CPDR 0859	90	CPDE 0859	132
700022241	150	CPDL 0859	60	CPDR 0859	92	CPDE 0859	137
700022242	156	CPDL 0859	61	CPDR 0859	95	CPDE 0859	141
700022243	198	CPDL 0859	71	CPDR 0859	113	CPDE 0859	172
700022244	210	CPDL 0859	74	CPDR 0859	118	CPDE 0859	181
700022245	222	CPDL 0859	76	CPDR 0859	123	CPDE 0859	189
700022246	234	CPDL 0859	79	CPDR 0859	128	CPDE 0859	198

Tower units
Columns
Colonnes

Decorative side panels
Paneles decorativos
Panneaux décoratifs

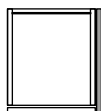
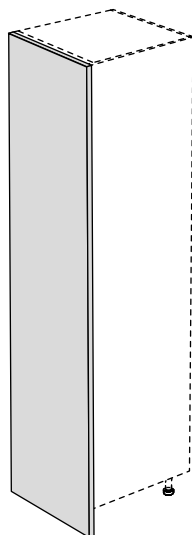

Support side panels.
Panel thickness, 19 mm.
On level with front.

Costado de apoyo.
Espesor de panel, 19 mm.
A ras de frente.

Côtés de soutien.
Épaisseur du panneau, 19 mm.
Au ras de façade.

61 depth / profundidad / profondeur

SAP	Unit height Altura módulo Hauteur module	Plinth Zócalo Plinthe	Total height Altura total Hauteur totale	R1		R2		R3	
				CCAL	CCAR	CCAL	CCAR	CCAE	CCAR
700022251	150	10	160	CCAL 0860	92	CCAR 0860	148	CCAE 0860	229
700022255		12	162	CCAL 0861	93	CCAR 0861	150	CCAE 0861	231
700022252	198	10	208	CCAL 0860	108	CCAR 0860	180	CCAE 0860	285
700022261		12	210	CCAL 0861	109	CCAR 0861	181	CCAE 0861	288
700022253	210	10	220	CCAL 0860	112	CCAR 0860	187	CCAE 0860	299
700022262		12	222	CCAL 0861	113	CCAR 0861	189	CCAE 0861	302
700022254	222	10	232	CCAL 0860	116	CCAR 0860	195	CCAE 0860	313
700022263		12	234	CCAL 0861	117	CCAR 0861	196	CCAE 0861	316
700022255	234	10	244	CCAL 0860	127	CCAR 0860	211	CCAE 0860	335
700022264		12	246	CCAL 0861	128	CCAR 0861	212	CCAE 0861	337

45 depth / profundidad / profondeur

SAP	Unit height Altura módulo Hauteur module	Plinth Zócalo Plinthe	Total height Altura total Hauteur totale	R1		R2		R3	
				CCAL	CCAR	CCAL	CCAR	CCAE	CCAR
700022269	150	10	160	CCAL 0862	76	CCAR 0862	120	CCAE 0862	180
700022278		12	162	CCAL 0863	77	CCAR 0863	121	CCAE 0863	181
700022270	198	10	208	CCAL 0862	92	CCAR 0862	147	CCAE 0862	226
700022279		12	210	CCAL 0863	92	CCAR 0863	148	CCAE 0863	227
700022271	210	10	220	CCAL 0862	95	CCAR 0862	153	CCAE 0862	236
700022280		12	222	CCAL 0863	96	CCAR 0863	154	CCAE 0863	238
700022272	222	10	232	CCAL 0862	98	CCAR 0862	159	CCAE 0862	247
700022281		12	234	CCAL 0863	99	CCAR 0863	160	CCAE 0863	249
700022273	234	10	244	CCAL 0862	101	CCAR 0862	165	CCAE 0862	257
700022282		12	246	CCAL 0863	102	CCAR 0863	166	CCAE 0863	259

35 depth / profundidad / profondeur

SAP	Unit height Altura módulo Hauteur module	Plinth Zócalo Plinthe	Total height Altura total Hauteur totale	R1		R2		R3	
				CCAL	CCAR	CCAL	CCAR	CCAE	CCAR
700022287	150	10	160	CCAL 0864	65	CCAR 0864	100	CCAE 0864	147
700022296		12	162	CCAL 0865	69	CCAR 0865	105	CCAE 0865	152
700022288	198	10	208	CCAL 0864	78	CCAR 0864	123	CCAE 0864	185
700022297		12	210	CCAL 0865	79	CCAR 0865	124	CCAE 0865	186
700022289	210	10	220	CCAL 0864	81	CCAR 0864	128	CCAE 0864	193
700022298		12	222	CCAL 0865	81	CCAR 0865	129	CCAE 0865	194
700022290	222	10	232	CCAL 0864	83	CCAR 0864	133	CCAE 0864	201
700022299		12	234	CCAL 0865	84	CCAR 0865	133	CCAE 0865	203
700022291	234	10	244	CCAL 0864	90	CCAR 0864	141	CCAE 0864	214
700022300		12	246	CCAL 0865	90	CCAR 0865	142	CCAE 0865	215

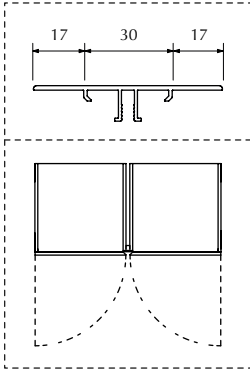
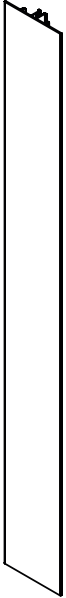

Vertical spacer profil between tower units.
Steel profile finish.
The fittings to fix the profile to the tower units are included.

Perfil separador entre módulos columna.
Acabado del perfil en acero.
Los herrajes para fijar el perfil a los módulos columnas están incluidos.

Profil séparateur entre modules colonne.
Finition du profil en acier.
Les accessoires pour fixer le profil aux modules colonne sont inclus.

SAP	Code Código Code	Height Altura Hauteur	Position Posición Position	Steel finish Acabado acero Finition acier
700022305	CSA 0870	150	-	92
700022306	CSA 0870	198	-	112
700022307	CSA 0870	210	-	116
700022308	CSA 0870	222	-	122
700022309	CSA 0870	234	-	126

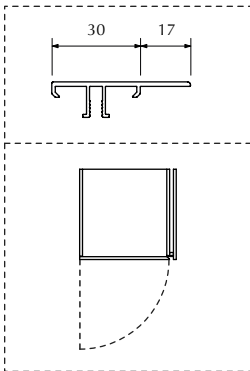
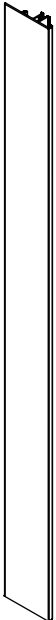

End side profile for tower units.
Steel profile finish.
The fittings to fix the profile to the tower units are included.

Perfil de terminación para columnas.
Acabado del perfil en acero.
Incluye los herrajes de unión a los módulos columna.

Profil latéral pour modules colonne.
Finition du profil en acier.
Les accessoires pour fixer le profil aux modules colonne sont inclus.

SAP	Code Código Code	Height Altura Hauteur	Position Posición Position	Steel finish Acabado acero Finition acier
700022310	CTA 0871	150	L / R	89
700022311	CTA 0871	198	L / R	107
700022312	CTA 0871	210	L / R	111
700022313	CTA 0871	222	L / R	117
700022314	CTA 0871	234	L / R	121



Profile between tower units for integrated dishwasher / washing machine.
Without overhang on one/two sides (78cm height).
Steel profile finish.
The fittings to fix the profile to the tower units are included.

Perfil entre módulos columna para lavavajillas / lavadoras integrados.
1 ó 2 recortes de la solapa lateral a la altura de 78 cm.
Acabado del perfil en acero.
Los herrajes para fijar el perfil a los módulos columnas están incluidos.

Profil entre modules colonne pour lave-vaisselle / lave-linge intégrés.
1 ou 2 découpe du rabat latéral à 78 cm.
Finition du profil en acier.
Panneau en la finition de le caisson.
Épaisseur du panneau, - mm.

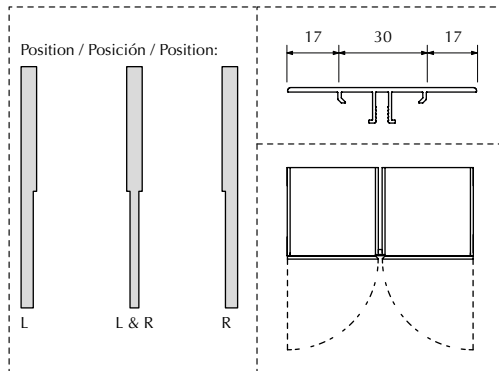

SAP	Code Código Code	Height Altura Hauteur	Position Posición Position	Steel finish Acabado acero Finition acier
700022315	CSEA 0872	150	L	114
700022316	CSEA 0872	198	L	134
700022317	CSEA 0872	210	L	138
700022318	CSEA 0872	222	L	144
700022319	CSEA 0872	234	L	148
700022320	CSEA 0873	150	R	114
700022321	CSEA 0873	198	R	134
700022322	CSEA 0873	210	R	138
700022323	CSEA 0873	222	R	144
700022324	CSEA 0873	234	R	148
700022325	CSEA 0874	150	L / R	124
700022326	CSEA 0874	198	L / R	143
700022327	CSEA 0874	210	L / R	148
700022328	CSEA 0874	222	L / R	153
700022329	CSEA 0874	234	L / R	158



End side profile without flap for integrated appliances.
Without overhang on one side only (78cm height).
Steel profile finish.
The fittings to fix the profile to the tower units are included.

Perfil de terminación sin pestaña para electrodomésticos integrados.
1 Recorte de la solapa lateral a la altura de 78 cm.
Acabado del perfil en acero.
Los herrajes para fijar el perfil a los módulos columnas están incluidos.

Profil lateral sans rabat pour électroménagers intégrés.
1 découpe du rabat latéral à 78 cm.
Finition du profil en acier.
Les accessoires pour fixer le profil aux modules colonne sont inclus.

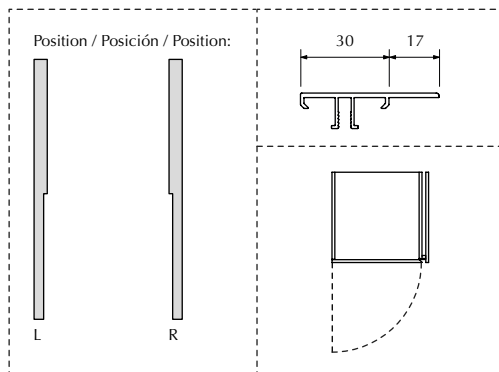

SAP	Code Código Code	Height Altura Hauteur	Position Posición Position	Steel finish Acabado acero Finition acier
700022330	CTEA 0875	150	L	111
700022331	CTEA 0875	198	L	128
700022332	CTEA 0875	210	L	132
700022333	CTEA 0875	222	L	136
700022334	CTEA 0875	234	L	140
700022335	CTEA 0876	150	R	111
700022336	CTEA 0876	198	R	128
700022337	CTEA 0876	210	R	132
700022338	CTEA 0876	222	R	136
700022339	CTEA 0876	234	R	140

05

wall units
módulos altos
modules hauts

Units / Módulos / Modules

p.180	H.36
p.186	H.48
p.192	H.60
p.200	H.72
p.210	H.84
p.220	H.96
p.228	H.108
p.236	H.120

Complements / Complementos / Compléments

p.244	Complements for wall unit Complementos para módulo alto Compléments pour module haut
-------	--

h. 36

Wall units
Módulos altos
Modules hauts

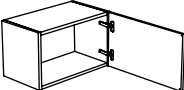
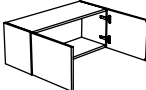
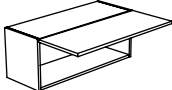
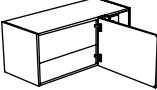
Type of unit Tipo de módulo Type de module	Available measures Medidas disponibles Dimensions disponibles	Available units Módulos disponibles Modules disponibles
<p>p.182 - 183 Wall unit with door Módulo alto con puerta Module haut avec porte</p>	<p>Depth / Profundidad / Profondeur (cm.): 35 - 61</p> <p>Width / Ancho / Largeur (cm.): 30 - 40 - 45 - 50 - 60 - 76,2 - 80 - 90 - 100 - 120</p>	<div style="display: flex; justify-content: space-around; align-items: center;"> <div style="text-align: center;">  AP 0200 - 0201 </div> <div style="text-align: center;">  AP 0202 - 0203 </div> <div style="text-align: center;">  AP 0204 - 0205 </div> </div>
<p>p.184 Wall corner unit Módulo alto rinconero Module haut encoignure</p>	<p>Depth / Profundidad / Profondeur (cm.): 35</p> <p>Width / Ancho / Largeur (cm.): 75 - 85 - 90 - 95 - 105</p>	<div style="text-align: center;">  ARR 0206 </div>

Wall units
Módulos altos
Modules hauts

Wall unit with door
Módulo alto con puerta
Module haut avec porte

H.36

Wall unit with door.
1 door.

Módulo alto con puerta.
1 puerta.

Modules haut avec porte.
1 porte.

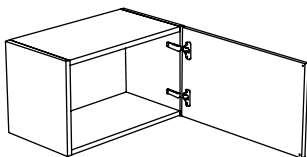

Availability / disponibilidad / disponibilité:

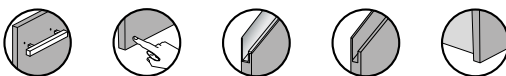

35 depth / profundidad / profondeur

SAP	Code Código Code	Width Ancho Largeur	Opening Apertura Ouverture											
				0	1	2	3	4	5	6	7	8	9	10
700020820	AP 0200	30	L / R	236	260	-	291	320	337	-	353	-	-	-
700020821	AP 0200	40	L / R	244	270	-	303	333	350	-	370	-	-	-
700020822	AP 0200	45	L / R	246	274	-	308	337	354	-	375	-	-	-
700020823	AP 0200	50	L / R	248	277	-	312	341	358	-	381	-	-	-
700020824	AP 0200	60	L / R	253	283	-	320	350	367	-	393	-	-	-

61 depth / profundidad / profondeur

SAP	Code Código Code	Width Ancho Largeur	Opening Apertura Ouverture											
				0	1	2	3	4	5	6	7	8	9	10
700020825	AP 0201	30	L / R	254	278	-	310	339	357	-	373	-	-	-
700020826	AP 0201	40	L / R	262	288	-	322	351	369	-	389	-	-	-
700020827	AP 0201	45	L / R	265	292	-	327	356	374	-	396	-	-	-
700020828	AP 0201	50	L / R	268	296	-	333	362	379	-	403	-	-	-
700020829	AP 0201	60	L / R	281	310	-	350	379	397	-	424	-	-	-

H. 36

Wall unit with door.
2 doors.

Módulo alto con puerta.
2 puertas.

Modules haut avec porte.
2 portes.

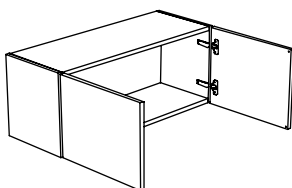

Availability / disponibilidad / disponibilité:

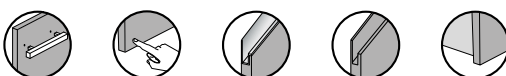

35 depth / profundidad / profondeur

SAP	Code Código Code	Width Ancho Largeur	Opening Apertura Ouverture											
				0	1	2	3	4	5	6	7	8	9	10
700020830	AP 0202	76,2	-	275	336	-	381	445	472	-	506	-	-	-
700020831	AP 0202	80	-	277	339	-	384	446	475	-	510	-	-	-
700020832	AP 0202	90	-	292	355	-	415	464	494	-	533	-	-	-
700020833	AP 0202	100	-	306	371	-	434	483	514	-	556	-	-	-
700020834	AP 0202	120	-	316	383	-	452	500	531	-	580	-	-	-

61 depth / profundidad / profondeur

SAP	Code Código Code	Width Ancho Largeur	Opening Apertura Ouverture											
				0	1	2	3	4	5	6	7	8	9	10
700020835	AP 0203	76,2	-	307	367	-	427	478	506	-	540	-	-	-
700020836	AP 0203	80	-	310	370	-	431	479	510	-	546	-	-	-
700020837	AP 0203	90	-	320	381	-	445	493	524	-	563	-	-	-
700020838	AP 0203	100	-	337	400	-	467	514	546	-	589	-	-	-
700020839	AP 0203	120	-	356	422	-	496	543	574	-	624	-	-	-

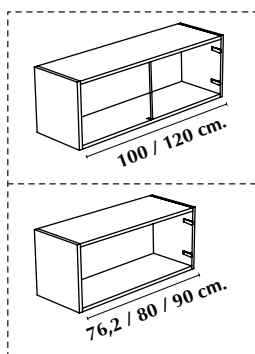

Wall units
Módulos altos
Modules hauts

Wall unit with door
Módulo alto con puerta
Module haut avec porte

H.36

Wall unit with door.
1 flap door.

Módulo alto con puerta.
1 puerta abatible.

Modules haut avec porte.
1 porte rabattable.

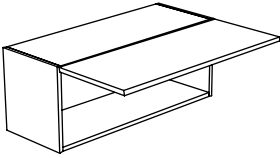

Availability / disponibilidad / disponibilité:

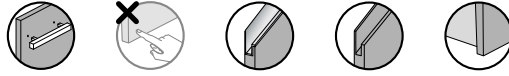

35 depth / profundidad / profondeur

SAP	Code Código Code	Width Ancho Largeur	Opening Apertura Ouverture											
				0	1	2	3	4	5	6	7	8	9	10
700020840	AA 0204	30	-	313	334	-	372	400	419	-	445	-	-	-
700020841	AA 0204	40	-	321	344	-	385	413	432	-	462	-	-	-
700020842	AA 0204	45	-	324	348	-	389	418	436	-	468	-	-	-
700020843	AA 0204	50	-	326	351	-	393	422	441	-	474	-	-	-
700020844	AA 0204	60	-	330	357	-	401	430	449	-	486	-	-	-
700020845	AA 0204	76,2	-	339	369	-	417	449	465	-	498	-	-	-
700020846	AA 0204	80	-	341	371	-	420	451	468	-	503	-	-	-
700020847	AA 0204	90	-	355	390	-	443	473	495	-	534	-	-	-
700020848	AA 0204	100	-	370	407	-	462	494	515	-	557	-	-	-
700020849	AA 0204	120	-	379	419	-	479	512	532	-	571	-	-	-

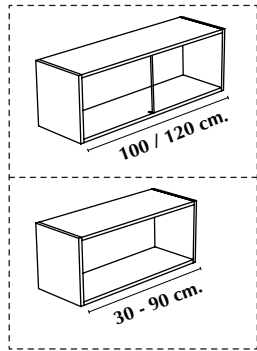

61 depth / profundidad / profondeur

SAP	Code Código Code	Width Ancho Largeur	Opening Apertura Ouverture											
				0	1	2	3	4	5	6	7	8	9	10
700020850	AA 0205	30	-	331	352	-	392	419	439	-	466	-	-	-
700020851	AA 0205	40	-	339	361	-	403	432	451	-	481	-	-	-
700020852	AA 0205	45	-	342	366	-	409	437	456	-	489	-	-	-
700020853	AA 0205	50	-	346	370	-	414	443	462	-	496	-	-	-
700020854	AA 0205	60	-	359	384	-	432	460	479	-	518	-	-	-
700020855	AA 0205	76,2	-	371	399	-	451	482	499	-	538	-	-	-
700020856	AA 0205	80	-	374	402	-	452	483	503	-	544	-	-	-
700020857	AA 0205	90	-	384	417	-	468	502	525	-	570	-	-	-
700020858	AA 0205	100	-	400	435	-	489	525	547	-	590	-	-	-
700020859	AA 0205	120	-	420	458	-	517	554	575	-	625	-	-	-

Wall units
Módulos altos
Modules hauts

Wall corner unit
Módulo alto rinconero
Module haut encoignure

H.36

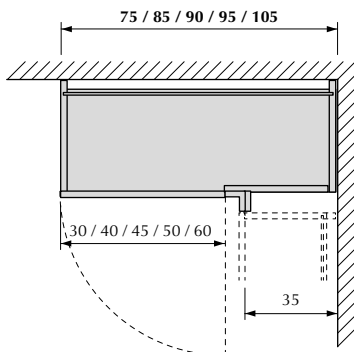
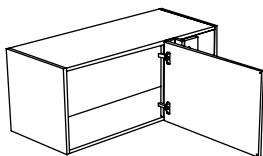

Wall straight corner unit.
1 door.
1 standard corner filler, 10x10 cm.

Módulo alto rinconero recto.
1 puerta.
1 regleta de rincón estándar de 10x10 cm.

Module haut encoignure droite.
1 porte.
1 fileur d'encoignure standard, 10x10 cm.

Availability / disponibilidad / disponibilité:

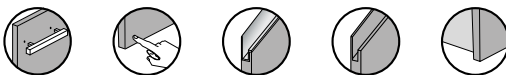

35 depth / profundidad / profondeur

SAP	Code Código Code	Width Ancho Largeur	Opening Apertura Ouverture	0	1	2	3	4	5	6	7	8	9	10
700020860	ARR 0206	75	L / R	360	412	-	458	485	509	-	549	-	-	-
700020861	ARR 0206	85	L / R	365	418	-	470	493	518	-	561	-	-	-
700020862	ARR 0206	90	L / R	377	431	-	481	508	533	-	568	-	-	-
700020863	ARR 0206	95	L / R	380	434	-	485	513	537	-	574	-	-	-
700020864	ARR 0206	105	L / R	384	440	-	493	521	546	-	586	-	-	-

H.36

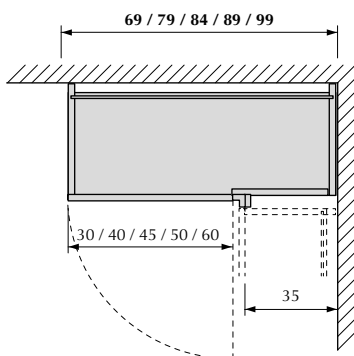
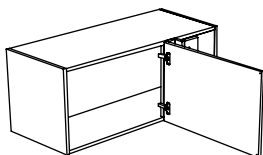

Wall straight corner unit.
1 door.
1 corner filler with raised door profile,
4x4 cm.

Módulo alto rinconero recto.
1 puerta.
1 regleta de rincón con perfil de puerta de
4x4 cm.

Module haut encoignure droite.
1 porte.
1 Fileur d'encoignure avec profilé de porte,
4x4 cm.

Availability / disponibilidad / disponibilité:

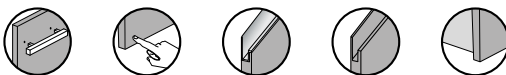

35 depth / profundidad / profondeur

SAP	Code Código Code	Width Ancho Largeur	Opening Apertura Ouverture	0	1	2	3	4	5	6	7	8	9	10
700021277	ARR 0206	69	L / R	358	409	-	481	523	550	-	603	-	-	-
700021278	ARR 0206	79	L / R	362	415	-	481	531	558	-	603	-	-	-
700021279	ARR 0206	84	L / R	364	418	-	485	536	563	-	609	-	-	-
700021280	ARR 0206	89	L / R	367	422	-	489	540	567	-	616	-	-	-
700021281	ARR 0206	99	L / R	381	438	-	509	559	586	-	639	-	-	-

h. 48

Wall units
Módulos altos
Modules hauts

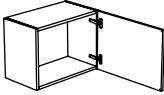
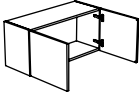
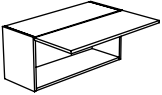
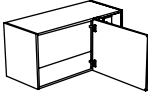
Type of unit Tipo de módulo Type de module	Available measures Medidas disponibles Dimensions disponibles	Available units Módulos disponibles Modules disponibles
<p>p.188 - 189 Wall unit with door Módulo alto con puerta Module haut avec porte</p>	<p>Depth / Profundidad / Profondeur (cm.): 35 - 61</p> <p>Width / Ancho / Largeur (cm.): 30 - 40 - 45 - 50 - 60 - 76,2 - 80 - 90 - 100 - 120</p>	<div style="display: flex; justify-content: space-around; align-items: flex-start;"> <div style="text-align: center;">  <p>AP 0208 - 0209</p> </div> <div style="text-align: center;">  <p>AP 0210 - 0211</p> </div> <div style="text-align: center;">  <p>AP 0212 - 0213</p> </div> </div>
<p>p.190 Wall corner unit Módulo alto rinconero Module haut encoignure</p>	<p>Depth / Profundidad / Profondeur (cm.): 35</p> <p>Width / Ancho / Largeur (cm.): 75 - 85 - 90 - 95 - 105</p>	<div style="text-align: center;">  <p>ARR 0214</p> </div>

Wall units
Módulos altos
Modules hauts

Wall unit with door
Módulo alto con puerta
Module haut avec porte

H.48

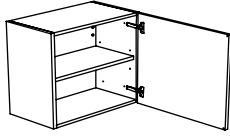

Wall unit with door.
1 door.
1 shelf.

Módulo alto con puerta.
1 puerta.
1 balda.

Modules haut avec porte.
1 porte.
1 étagère.

Availability / disponibilidad / disponibilité:

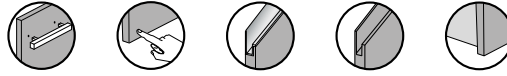

35 depth / profundidad / profondeur

SAP	Code Código Code	Width Ancho Largeur	Opening Apertura Ouverture											
				0	1	2	3	4	5	6	7	8	9	10
700020865	AP 0208	30	L / R	266	292	-	327	348	367	-	401	-	-	-
700020866	AP 0208	40	L / R	276	304	-	342	363	382	-	414	-	-	-
700020867	AP 0208	45	L / R	279	308	-	348	368	388	-	422	-	-	-
700020868	AP 0208	50	L / R	283	312	-	353	373	393	-	430	-	-	-
700020869	AP 0208	60	L / R	289	321	-	365	391	412	-	446	-	-	-

61 depth / profundidad / profondeur

SAP	Code Código Code	Width Ancho Largeur	Opening Apertura Ouverture											
				0	1	2	3	4	5	6	7	8	9	10
700020870	AP 0209	30	L / R	292	316	-	354	378	397	-	430	-	-	-
700020871	AP 0209	40	L / R	301	328	-	368	391	412	-	445	-	-	-
700020872	AP 0209	45	L / R	306	333	-	375	398	423	-	459	-	-	-
700020873	AP 0209	50	L / R	310	339	-	383	405	430	-	469	-	-	-
700020874	AP 0209	60	L / R	329	359	-	407	433	455	-	494	-	-	-

H. 48

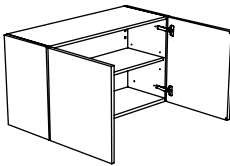

Wall unit with door.
2 doors.
1 shelf.

Módulo alto con puerta.
2 puertas.
1 balda.

Modules haut avec porte.
2 portes.
1 étagère.

Availability / disponibilidad / disponibilité:

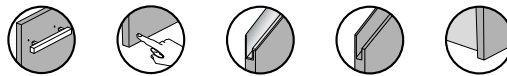

35 depth / profundidad / profondeur

SAP	Code Código Code	Width Ancho Largeur	Opening Apertura Ouverture											
				0	1	2	3	4	5	6	7	8	9	10
700020875	AP 0210	76,2	-	317	388	-	447	486	516	-	569	-	-	-
700020876	AP 0210	80	-	320	391	-	451	495	530	-	586	-	-	-
700020877	AP 0210	90	-	333	406	-	470	508	549	-	610	-	-	-
700020878	AP 0210	100	-	367	435	-	507	548	590	-	657	-	-	-
700020879	AP 0210	120	-	382	462	-	533	578	616	-	680	-	-	-

61 depth / profundidad / profondeur

SAP	Code Código Code	Width Ancho Largeur	Opening Apertura Ouverture											
				0	1	2	3	4	5	6	7	8	9	10
700020880	AP 0211	76,2	-	362	425	-	491	537	569	-	624	-	-	-
700020881	AP 0211	80	-	366	429	-	497	538	579	-	637	-	-	-
700020882	AP 0211	90	-	375	440	-	507	553	594	-	657	-	-	-
700020883	AP 0211	100	-	412	478	-	551	595	638	-	694	-	-	-
700020884	AP 0211	120	-	439	509	-	584	632	677	-	742	-	-	-

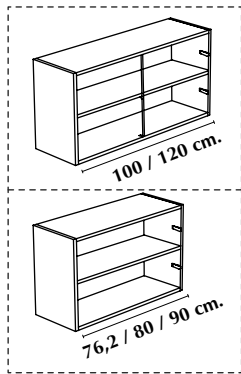

Wall units
Módulos altos
Modules hauts

Wall unit with door
Módulo alto con puerta
Module haut avec porte

H.48

Wall unit with door.
1 flap door.
1 shelf.

Módulo alto con puerta.
1 puerta abatible.
1 balda.

Modules haut avec porte.
1 porte rabattable.
1 étagère.

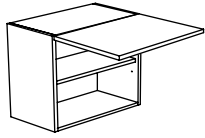

Availability / disponibilidad / disponibilité:

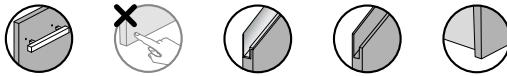

35 depth / profundidad / profondeur

SAP	Code Código Code	Width Ancho Largeur	Opening Apertura Ouverture											
				0	1	2	3	4	5	6	7	8	9	10
700020885	AA 0212	30	-	344	366	-	409	435	456	-	487	-	-	-
700020886	AA 0212	40	-	354	378	-	424	450	471	-	507	-	-	-
700020887	AA 0212	45	-	359	384	-	431	457	479	-	518	-	-	-
700020888	AA 0212	50	-	362	388	-	437	463	485	-	526	-	-	-
700020889	AA 0212	60	-	368	397	-	448	474	496	-	542	-	-	-
700020890	AA 0212	76,2	-	381	417	-	473	503	526	-	580	-	-	-
700020891	AA 0212	80	-	401	436	-	491	522	549	-	594	-	-	-
700020892	AA 0212	90	-	414	451	-	509	541	568	-	618	-	-	-
700020893	AA 0212	100	-	447	486	-	550	581	609	-	664	-	-	-
700020894	AA 0212	120	-	467	510	-	579	611	639	-	703	-	-	-

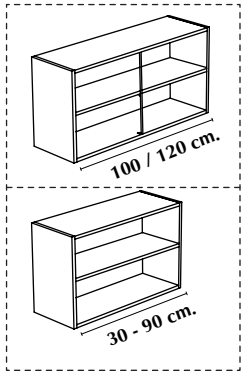

61 depth / profundidad / profondeur

SAP	Code Código Code	Width Ancho Largeur	Opening Apertura Ouverture											
				0	1	2	3	4	5	6	7	8	9	10
700020895	AA 0213	30	-	369	390	-	435	462	483	-	515	-	-	-
700020896	AA 0213	40	-	378	402	-	450	476	498	-	535	-	-	-
700020897	AA 0213	45	-	385	409	-	459	485	507	-	546	-	-	-
700020898	AA 0213	50	-	389	415	-	466	492	514	-	556	-	-	-
700020899	AA 0213	60	-	408	435	-	490	516	539	-	586	-	-	-
700020900	AA 0213	76,2	-	426	460	-	521	550	574	-	630	-	-	-
700020901	AA 0213	80	-	447	481	-	539	570	598	-	644	-	-	-
700020902	AA 0213	90	-	456	492	-	554	585	613	-	664	-	-	-
700020903	AA 0213	100	-	493	530	-	597	629	657	-	713	-	-	-
700020904	AA 0213	120	-	524	565	-	639	671	700	-	766	-	-	-

Wall units
Módulos altos
Modules hauts

Wall corner unit
Módulo alto rinconero
Module haut encoignure

H.48

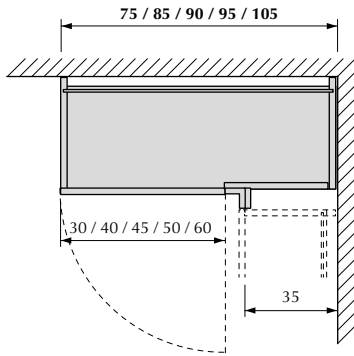
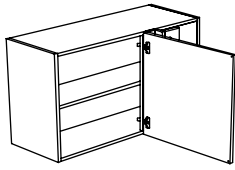

Wall straight corner unit.
1 door.
1 shelf.
1 standard corner filler, 10x10 cm.

Módulo alto rinconero recto.
1 puerta.
1 balda.
1 regleta de rincón estándar de 10x10 cm.

Module haut encoignure droite.
1 porte.
1 étagère.
1 fileur d'encoignure standard, 10x10 cm.

Availability / disponibilidad / disponibilité:

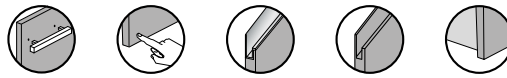

35 depth / profundidad / profondeur

SAP	Code Código Code	Width Ancho Largeur	Opening Apertura Ouverture	0	1	2	3	4	5	6	7	8	9	10
700020905	ARR 0214	75	L / R	407	460	-	513	538	566	-	615	-	-	-
700020906	ARR 0214	85	L / R	413	468	-	524	549	578	-	631	-	-	-
700020907	ARR 0214	90	L / R	423	479	-	537	561	591	-	647	-	-	-
700020908	ARR 0214	95	L / R	426	483	-	543	567	596	-	643	-	-	-
700020909	ARR 0214	105	L / R	435	494	-	556	581	611	-	662	-	-	-

H.48

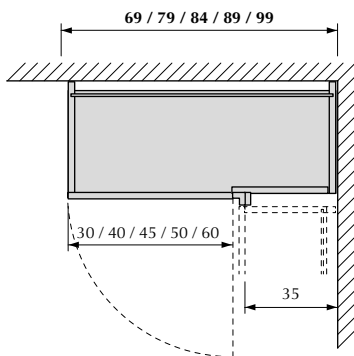
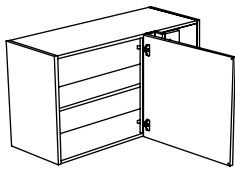

Wall straight corner unit.
1 door.
1 shelf.
1 corner filler with raised door profile,
4x4 cm.

Módulo alto rinconero recto.
1 puerta.
1 balda.
1 regleta de rincón con perfil de puerta de
4x4 cm.

Module haut encoignure droite.
1 porte.
1 étagère.
1 Fileur d'encoignure avec profilé de porte,
4x4 cm.

Availability / disponibilidad / disponibilité:

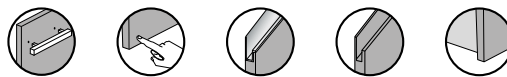



35 depth / profundidad / profondeur

SAP	Code Código Code	Width Ancho Largeur	Opening Apertura Ouverture	0	1	2	3	4	5	6	7	8	9	10
700021282	ARR 0214	69	L / R	403	456	-	528	574	606	-	656	-	-	-
700021283	ARR 0214	79	L / R	409	465	-	540	585	617	-	672	-	-	-
700021284	ARR 0214	84	L / R	412	469	-	546	590	623	-	680	-	-	-
700021285	ARR 0214	89	L / R	415	473	-	551	595	629	-	688	-	-	-
700021286	ARR 0214	99	L / R	428	488	-	571	618	648	-	712	-	-	-

h. 60

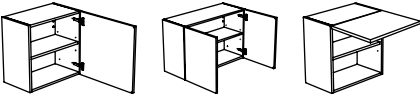
Wall units
Módulos altos
Modules hauts

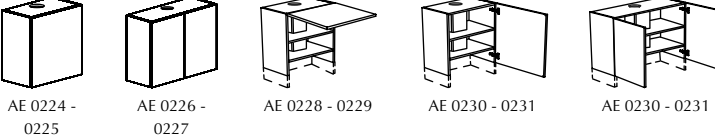
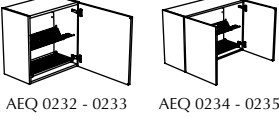
Type of unit Tipo de módulo Type de module	Available measures Medidas disponibles Dimensions disponibles	Available units Módulos disponibles Modules disponibles
<p>p.194 - 195</p> <p>Wall unit with door Módulo alto con puerta Module haut avec porte</p>	<p>Depth / Profundidad / Profondeur (cm.): 35 - 61</p> <p>Width / Ancho / Largeur (cm.): 30 - 40 - 45 - 50 - 60 - 76,2 - 80 - 90 - 100 - 120</p>	 <p>AP 0216 - 0217 AP 0218 - 0219 AP 0220 - 0221</p>
<p>p.196</p> <p>Wall corner unit Módulo alto rinconero Module haut encoignure</p>	<p>Depth / Profundidad / Profondeur (cm.): 35</p> <p>Width / Ancho / Largeur (cm.): 75 - 85 - 90 - 95 - 105</p>	 <p>ARR 0222</p>
<p>p.197 - 198</p> <p>Wall unit for extractor Módulo alto para extractor Module haut pour hotte</p>	<p>Depth / Profundidad / Profondeur (cm.): 35 - 61</p> <p>Width / Ancho / Largeur (cm.): 60 - 90 - 120</p>	 <p>AE 0224 - 0225 AE 0226 - 0227 AE 0228 - 0229 AE 0230 - 0231 AE 0230 - 0231</p>
<p>p.199</p> <p>Wall unit for plate draining rack Módulo alto para escurrreplatos Module haut pour égouttoir</p>	<p>Depth / Profundidad / Profondeur (cm.): 35 - 61</p> <p>Width / Ancho / Largeur (cm.): 45 - 50 - 60 - 80 - 90</p>	 <p>AEQ 0232 - 0233 AEQ 0234 - 0235</p>

Wall units
Módulos altos
Modules hauts

Wall unit with door
Módulo alto con puerta
Module haut avec porte

H.60

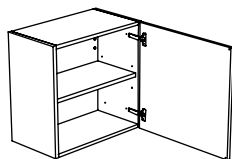

Wall unit with door.
1 door.
1 shelf.

Módulo alto con puerta.
1 puerta.
1 balda.

Modules haut avec porte.
1 porte.
1 étagère.

Availability / disponibilidad / disponibilité:

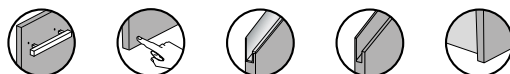

35 depth / profundidad / profondeur

SAP	Code Código Code	Width Ancho Largeur	Opening Apertura Ouverture											
				0	1	2	3	4	5	6	7	8	9	10
700020910	AP 0216	30	L / R	272	299	-	336	359	383	-	415	-	-	-
700020911	AP 0216	40	L / R	282	312	-	353	378	400	-	438	-	-	-
700020912	AP 0216	45	L / R	285	316	-	359	384	406	-	447	-	-	-
700020913	AP 0216	50	L / R	288	321	-	365	390	413	-	456	-	-	-
700020914	AP 0216	60	L / R	298	337	-	385	410	437	-	487	-	-	-

61 depth / profundidad / profondeur

SAP	Code Código Code	Width Ancho Largeur	Opening Apertura Ouverture											
				0	1	2	3	4	5	6	7	8	9	10
700020915	AP 0217	30	L / R	306	332	-	373	398	420	-	453	-	-	-
700020916	AP 0217	40	L / R	316	344	-	388	413	436	-	475	-	-	-
700020917	AP 0217	45	L / R	320	350	-	396	421	444	-	486	-	-	-
700020918	AP 0217	50	L / R	325	356	-	404	428	452	-	497	-	-	-
700020919	AP 0217	60	L / R	347	384	-	433	461	489	-	531	-	-	-

H. 60

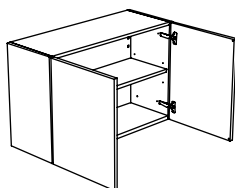

Wall unit with door.
2 doors.
1 shelf.

Módulo alto con puerta.
2 puertas.
1 balda.

Modules haut avec porte.
2 portes.
1 étagère.

Availability / disponibilidad / disponibilité:

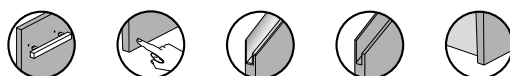

35 depth / profundidad / profondeur

SAP	Code Código Code	Width Ancho Largeur	Opening Apertura Ouverture											
				0	1	2	3	4	5	6	7	8	9	10
700020920	AP 0218	76,2	-	324	393	-	455	502	542	-	606	-	-	-
700020921	AP 0218	80	-	326	396	-	460	503	545	-	607	-	-	-
700020922	AP 0218	90	-	340	412	-	480	517	557	-	627	-	-	-
700020923	AP 0218	100	-	375	449	-	513	559	611	-	677	-	-	-
700020924	AP 0218	120	-	394	480	-	557	609	659	-	737	-	-	-

61 depth / profundidad / profondeur

SAP	Code Código Code	Width Ancho Largeur	Opening Apertura Ouverture											
				0	1	2	3	4	5	6	7	8	9	10
700020925	AP 0219	76,2	-	378	445	-	512	553	600	-	653	-	-	-
700020926	AP 0219	80	-	382	449	-	518	555	601	-	661	-	-	-
700020927	AP 0219	90	-	391	462	-	535	576	623	-	683	-	-	-
700020928	AP 0219	100	-	430	501	-	576	626	669	-	736	-	-	-
700020929	AP 0219	120	-	461	544	-	627	679	730	-	809	-	-	-

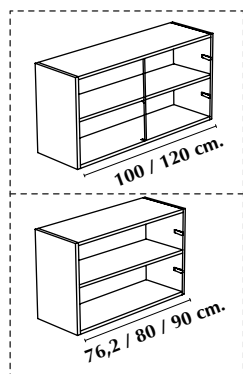

Wall units
Módulos altos
Modules hauts

Wall unit with door
Módulo alto con puerta
Module haut avec porte

H.60

Wall unit with door.
1 flap door.
1 shelf.

Módulo alto con puerta.
1 puerta abatible.
1 balda.

Modules haut avec porte.
1 porte rabattable.
1 étagère.

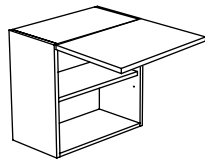

Availability / disponibilidad / disponibilité:

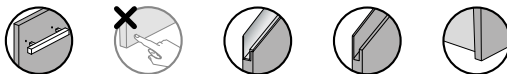

35 depth / profundidad / profondeur

SAP	Code Código Code	Width Ancho Largeur	Opening Apertura Ouverture											
				0	1	2	3	4	5	6	7	8	9	10
700020930	AA 0220	30	-	351	375	-	420	445	467	-	502	-	-	-
700020931	AA 0220	40	-	378	404	-	454	478	502	-	544	-	-	-
700020932	AA 0220	45	-	381	408	-	456	484	509	-	553	-	-	-
700020933	AA 0220	50	-	384	413	-	462	490	515	-	563	-	-	-
700020934	AA 0220	60	-	393	427	-	480	509	538	-	592	-	-	-
700020935	AA 0220	76,2	-	409	448	-	507	537	565	-	623	-	-	-
700020936	AA 0220	80	-	411	451	-	511	539	569	-	625	-	-	-
700020937	AA 0220	90	-	428	470	-	534	561	593	-	653	-	-	-
700020938	AA 0220	100	-	463	507	-	577	604	637	-	703	-	-	-
700020939	AA 0220	120	-	482	535	-	612	641	680	-	752	-	-	-

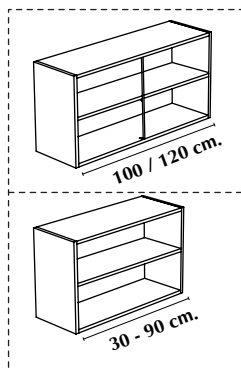

61 depth / profundidad / profondeur

SAP	Code Código Code	Width Ancho Largeur	Opening Apertura Ouverture											
				0	1	2	3	4	5	6	7	8	9	10
700020940	AA 0221	30	-	385	408	-	452	481	504	-	540	-	-	-
700020941	AA 0221	40	-	412	436	-	490	514	538	-	581	-	-	-
700020942	AA 0221	45	-	416	442	-	493	521	546	-	592	-	-	-
700020943	AA 0221	50	-	421	448	-	501	529	554	-	603	-	-	-
700020944	AA 0221	60	-	443	476	-	533	562	592	-	648	-	-	-
700020945	AA 0221	76,2	-	463	500	-	563	593	622	-	688	-	-	-
700020946	AA 0221	80	-	466	504	-	569	596	628	-	690	-	-	-
700020947	AA 0221	90	-	479	520	-	589	615	648	-	710	-	-	-
700020948	AA 0221	100	-	518	560	-	634	661	695	-	763	-	-	-
700020949	AA 0221	120	-	549	599	-	682	718	751	-	831	-	-	-

Wall units
Módulos altos
Modules hauts

Wall corner unit
Módulo alto rinconero
Module haut encoignure

H.60

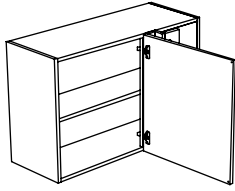

Wall straight corner unit.
1 door.
1 shelf.
1 standard corner filler, 10x10 cm.

Módulo alto rinconero recto.
1 puerta.
1 balda.
1 regleta de rincón estándar de 10x10 cm.

Module haut encoignure droite.
1 porte.
1 étagère.
1 fileur d'encoignure standard, 10x10 cm.

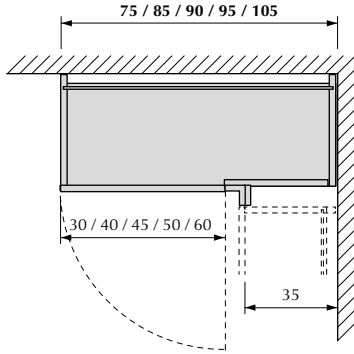

Availability / disponibilidad / disponibilité:

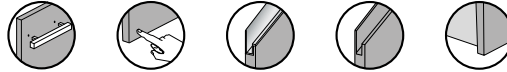

35 depth / profundidad / profondeur

SAP	Code Código Code	Width Ancho Largeur	Opening Apertura Ouverture	0	1	2	3	4	5	6	7	8	9	10
				700020950	ARR 0222	75	L / R	417	474	-	532	559	585	-
700020951	ARR 0222	85	L / R	424	484	-	544	570	598	-	648	-	-	-
700020952	ARR 0222	90	L / R	434	495	-	557	584	612	-	677	-	-	-
700020953	ARR 0222	95	L / R	437	499	-	564	590	618	-	674	-	-	-
700020954	ARR 0222	105	L / R	450	518	-	586	613	645	-	707	-	-	-

H.60

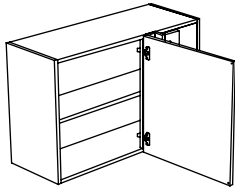

Wall straight corner unit.
1 door.
1 shelf.
1 corner filler with raised door profile,
4x4 cm.

Módulo alto rinconero recto.
1 puerta.
1 balda.
1 regleta de rincón con perfil de puerta de
4x4 cm.

Module haut encoignure droite.
1 porte.
1 étagère.
1 Fileur d'encoignure avec profilé de porte,
4x4 cm.

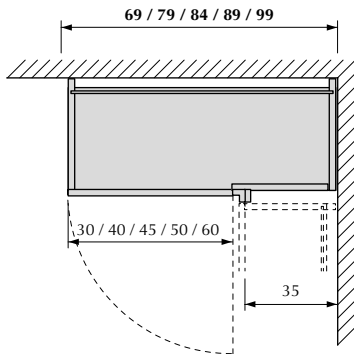

Availability / disponibilidad / disponibilité:

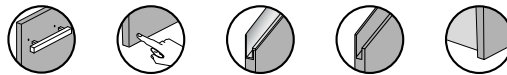

35 depth / profundidad / profondeur

SAP	Code Código Code	Width Ancho Largeur	Opening Apertura Ouverture	0	1	2	3	4	5	6	7	8	9	10
				700021287	ARR 0222	69	L / R	413	470	-	547	589	625	-
700021288	ARR 0222	79	L / R	420	480	-	560	606	638	-	701	-	-	-
700021289	ARR 0222	84	L / R	423	484	-	567	612	644	-	711	-	-	-
700021290	ARR 0222	89	L / R	426	489	-	573	618	651	-	720	-	-	-
700021291	ARR 0222	99	L / R	440	508	-	598	642	679	-	755	-	-	-

Wall units
Módulos altos
Modules hauts

Wall unit for extractor
Módulo alto para extractor
Module haut pour hotte

H.60

Wall unit for extractor.
1 fixed door.
Available in all models but without handle, except: See availability.

Módulo alto para extractor.
1 puerta fija.
Disponibile en todos los modelos, pero sin tirador, excepto: Ver disponibilidad.

Module haut pour hotte.
1 porte fixe.
Disponibile sur tous les modèles mais dispans poignée, à l'exception: Voir la disponibilité

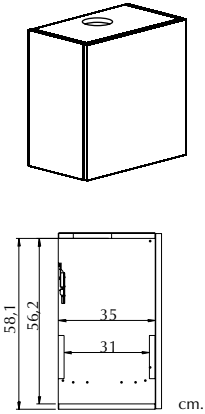

Availability / disponibilidad / disponibilité:

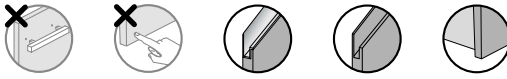

35 depth / profundidad / profondeur														
SAP	Code Código Code	Width Ancho Largeur	Opening Apertura Ouverture	0	1	2	3	4	5	6	7	8	9	10
700020955	AE 0224	60	-	299	337	-	382	411	438	-	488	-	-	-
700020956	AE 0224	90	-	320	367	-	421	452	478	-	536	-	-	-
700020957	AE 0224	120	-	338	397	-	461	495	527	-	591	-	-	-

61 depth / profundidad / profondeur														
SAP	Code Código Code	Width Ancho Largeur	Opening Apertura Ouverture	0	1	2	3	4	5	6	7	8	9	10
700020958	AE 0225	60	-	339	376	-	424	453	480	-	527	-	-	-
700020959	AE 0225	90	-	359	405	-	463	490	520	-	579	-	-	-
700020960	AE 0225	120	-	390	447	-	515	545	582	-	646	-	-	-

H.60

Wall unit for extractor.
2 fixed doors.
Available in all models but without handle, except: See availability.

Módulo alto para extractor.
2 puertas fijas.
Disponibile en todos los modelos, pero sin tirador, excepto: Ver disponibilidad.

Module haut pour hotte.
2 portes fixes.
Disponibile sur tous les modèles mais dispans poignée, à l'exception: Voir la disponibilité

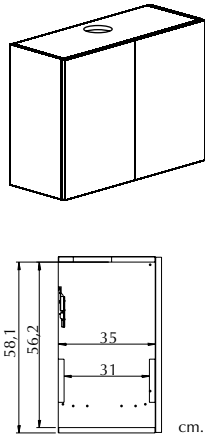

Availability / disponibilidad / disponibilité:

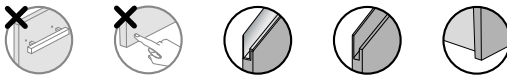

35 depth / profundidad / profondeur														
SAP	Code Código Code	Width Ancho Largeur	Opening Apertura Ouverture	0	1	2	3	4	5	6	7	8	9	10
700020961	AE 0226	90	-	330	403	-	469	507	547	-	617	-	-	-
700020962	AE 0226	120	-	348	443	-	513	556	604	-	687	-	-	-

61 depth / profundidad / profondeur														
SAP	Code Código Code	Width Ancho Largeur	Opening Apertura Ouverture	0	1	2	3	4	5	6	7	8	9	10
700020963	AE 0227	90	-	369	441	-	511	553	599	-	672	-	-	-
700020964	AE 0227	120	-	400	486	-	563	615	665	-	743	-	-	-

H.60

Wall unit for extractor.
1 flap door.
1 shelf.
Variable height.

Módulo alto para extractor.
1 puerta abatible.
1 balda.
Altura variable.

Module haut pour hotte.
1 porte rabattable.
1 étagère.
Hauteur variable.

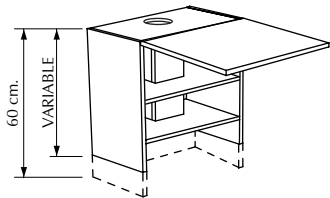

Availability / disponibilidad / disponibilité:

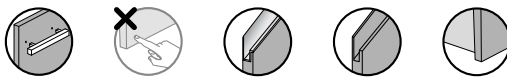

35 depth / profundidad / profondeur														
SAP	Code Código Code	Width Ancho Largeur	Opening Apertura Ouverture	0	1	2	3	4	5	6	7	8	9	10
700020965	AE 0228	60	-	572	599	-	667	691	728	-	789	-	-	-
700020966	AE 0228	90	-	605	641	-	720	751	782	-	846	-	-	-
700020967	AE 0228	120	-	632	678	-	768	804	840	-	921	-	-	-

61 depth / profundidad / profondeur														
SAP	Code Código Code	Width Ancho Largeur	Opening Apertura Ouverture	0	1	2	3	4	5	6	7	8	9	10
700020968	AE 0229	60	-	621	646	-	719	749	780	-	844	-	-	-
700020969	AE 0229	90	-	660	694	-	778	809	841	-	906	-	-	-
700020970	AE 0229	120	-	698	742	-	838	874	911	-	993	-	-	-

Wall units
Módulos altos
Modules hauts

Wall unit for extractor
Módulo alto para extractor
Module haut pour hotte

H.60

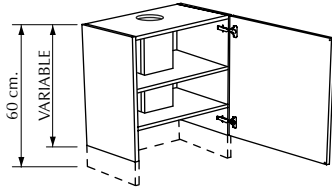

Wall unit for extractor.
1 door.
1 shelf.
Variable height.

Módulo alto para extractor.
1 puerta.
1 balda.
Altura variable.

Module haut pour hotte.
1 porte.
1 étagère.
Hauteur variable.

Availability / disponibilidad / disponibilité:

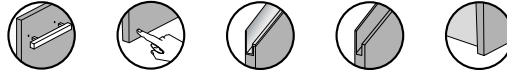

35 depth / profundidad / profondeur

SAP	Code Código Code	Width Ancho Largeur	Opening Apertura Ouverture	0	1	2	3	4	5	6	7	8	9	10
				700020971	AE 0230	60	-	475	507	-	567	596	626	-

61 depth / profundidad / profondeur

SAP	Code Código Code	Width Ancho Largeur	Opening Apertura Ouverture	0	1	2	3	4	5	6	7	8	9	10
				700020974	AE 0231	60	-	524	554	-	618	648	678	-

H.60

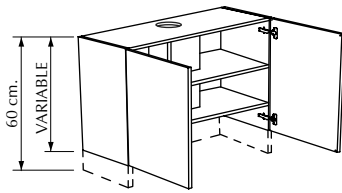

Wall unit for extractor.
2 doors.
1 shelf.
Variable height.

Módulo alto para extractor.
2 puertas.
1 balda.
Altura variable.

Module haut pour hotte.
2 portes.
1 étagère.
Hauteur variable.

Availability / disponibilidad / disponibilité:

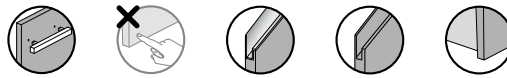

35 depth / profundidad / profondeur

SAP	Code Código Code	Width Ancho Largeur	Opening Apertura Ouverture	0	1	2	3	4	5	6	7	8	9	10
				700020972	AE 0230	90	-	517	582	-	657	693	743	-
700020973	AE 0230	120	-	544	623	-	708	741	789	-	874	-	-	-

61 depth / profundidad / profondeur

SAP	Code Código Code	Width Ancho Largeur	Opening Apertura Ouverture	0	1	2	3	4	5	6	7	8	9	10
				700020975	AE 0231	90	-	572	635	-	714	752	800	-
700020976	AE 0231	120	-	610	687	-	778	819	873	-	971	-	-	-

Wall units
Módulos altos
Modules hauts

Wall unit for plate draining rack
Módulo alto para escurrer platos
Module haut pour égouttoir

H.60

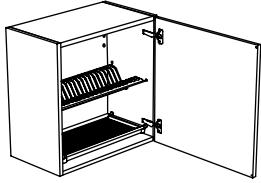

Wall unit for plate draining rack.
1 door.
1 glass draining tray.
1 plate draining tray.
1 water collecting tray.

Módulo alto para escurrer platos.
1 puerta.
1 bandeja escurrer-vasos.
1 bandeja escurrer-platos.
1 bandeja recoge-agua.

Module haut pour égouttoir.
1 porte.
1 plateau égouttoir verres.
1 plateau égouttoir assiettes.
1 plateau dévidoir.

Availability / disponibilidad / disponibilité:

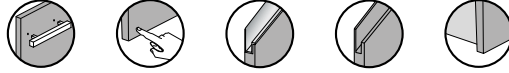

35 depth / profundidad / profondeur

SAP	Code Código Code	Width Ancho Largeur	Opening Apertura Ouverture	0	1	2	3	4	5	6	7	8	9	10
				700020977	AEQ 0232	45	L / R	343	372	-	417	444	468	-
700020978	AEQ 0232	50	L / R	350	380	-	427	454	479	-	525	-	-	-
700020979	AEQ 0232	60	L / R	369	404	-	455	484	512	-	565	-	-	-

61 depth / profundidad / profondeur

SAP	Code Código Code	Width Ancho Largeur	Opening Apertura Ouverture	0	1	2	3	4	5	6	7	8	9	10
				700020980	AEQ 0233	45	L / R	373	401	-	448	476	501	-
700020981	AEQ 0233	50	L / R	381	410	-	460	487	512	-	560	-	-	-
700020982	AEQ 0233	60	L / R	409	443	-	497	526	555	-	609	-	-	-

H. 60

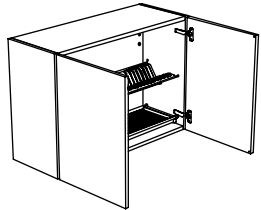

Wall unit for plate draining rack.
2 doors.
1 glass draining tray.
1 plate draining tray.
1 water collecting tray.

Módulo alto para escurrer platos.
2 puertas.
1 bandeja escurrer-vasos.
1 bandeja escurrer-platos.
1 bandeja recoge-agua.

Module haut pour égouttoir.
2 portes.
1 plateau égouttoir verres.
1 plateau égouttoir assiettes.
1 plateau dévidoir.

Availability / disponibilidad / disponibilité:

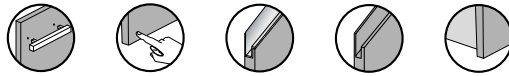

35 depth / profundidad / profondeur







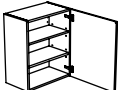
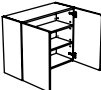
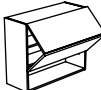
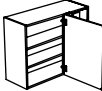

SAP	Code Código Code	Width Ancho Largeur	Opening Apertura Ouverture	0	1	2	3	4	5	6	7	8	9	10
				700020983	AEQ 0234	80	-	411	477	-	549	596	637	-
700020984	AEQ 0234	90	-	431	499	-	571	622	665	-	740	-	-	-

61 depth / profundidad / profondeur

SAP	Code Código Code	Width Ancho Largeur	Opening Apertura Ouverture	0	1	2	3	4	5	6	7	8	9	10
				700020985	AEQ 0235	80	-	455	519	-	591	642	684	-
700020986	AEQ 0235	90	-	470	537	-	613	663	707	-	784	-	-	-

h. 72

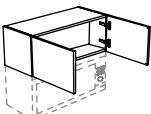
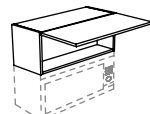
Wall units
Módulos altos
Modules hauts

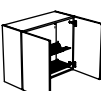
Type of unit Tipo de módulo Type de module	Available measures Medidas disponibles Dimensions disponibles	Available units Módulos disponibles Modules disponibles
<p>p.202 - 203</p> <p>Wall unit with door Módulo alto con puerta Module haut avec porte</p>	<p>Depth / Profundidad / Profondeur (cm.): 35 - 61</p> <p>Width / Ancho / Largeur (cm.): 30 - 40 - 45 - 50 - 60 - 76,2 - 80 - 90 - 100 - 120</p>	 <p>AP 0236 - 0237</p>  <p>AP 0238 - 0239</p>  <p>AP 0240 - 0241</p>
<p>p.204</p> <p>Wall corner unit Módulo alto rinconero Module haut encoignure</p>	<p>Depth / Profundidad / Profondeur (cm.): 35</p> <p>Width / Ancho / Largeur (cm.): 75 - 85 - 90 - 95 - 105</p>	 <p>ARR 0242</p>
<p>p.205 - 207</p> <p>Wall unit for extractor Módulo alto para extractor Module haut pour hotte</p>	<p>Depth / Profundidad / Profondeur (cm.): 35 - 61</p> <p>Width / Ancho / Largeur (cm.): 60 - 90 - 120</p>	 <p>AE 0244 - 0245</p>  <p>AE 0246 - 0247</p>  <p>AE 0248 - 0249</p>  <p>AE 0250 - 0251</p>  <p>AE 0250 - 0251</p>  <p>AE 0319</p>  <p>AE 0315</p>
<p>p.208</p> <p>Wall unit for plate draining rack Módulo alto para escurreplatos Module haut pour égouttoir</p>	<p>Depth / Profundidad / Profondeur (cm.): 35 - 61</p> <p>Width / Ancho / Largeur (cm.): 45 - 50 - 60 - 80 - 90</p>	 <p>AEQ 0252 - 0253</p>  <p>AEQ 0254 - 0255</p>

Wall units
Módulos altos
Modules hauts

Wall unit with door
Módulo alto con puerta
Module haut avec porte

H.72

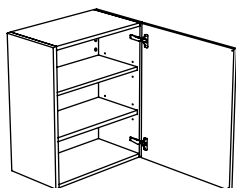

Wall unit with door.
1 door.
2 shelves.

Módulo alto con puerta.
1 puerta.
2 baldas.

Modules haut avec porte.
1 porte.
2 étagères.

Availability / disponibilidad / disponibilité:

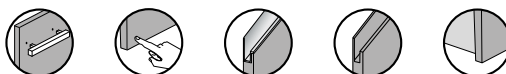

35 depth / profundidad / profondeur

SAP	Code Código Code	Width Ancho Largeur	Opening Apertura Ouverture											
				0	1	2	3	4	5	6	7	8	9	10
700020987	AP 0236	30	L / R	301	329	-	371	396	418	-	455	-	-	-
700020988	AP 0236	40	L / R	314	345	-	388	414	439	-	483	-	-	-
700020989	AP 0236	45	L / R	321	357	-	403	430	458	-	506	-	-	-
700020990	AP 0236	50	L / R	326	363	-	410	437	466	-	518	-	-	-
700020991	AP 0236	60	L / R	334	375	-	426	452	482	-	541	-	-	-

61 depth / profundidad / profondeur

SAP	Code Código Code	Width Ancho Largeur	Opening Apertura Ouverture											
				0	1	2	3	4	5	6	7	8	9	10
700020992	AP 0237	30	L / R	343	369	-	415	439	463	-	500	-	-	-
700020993	AP 0237	40	L / R	355	384	-	431	457	483	-	528	-	-	-
700020994	AP 0237	45	L / R	364	399	-	448	475	504	-	553	-	-	-
700020995	AP 0237	50	L / R	370	406	-	457	484	514	-	567	-	-	-
700020996	AP 0237	60	L / R	394	433	-	489	515	547	-	602	-	-	-

H. 72

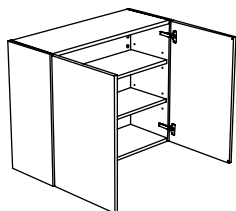

Wall unit with door.
2 doors.
2 shelves.

Módulo alto con puerta.
2 puertas.
2 baldas.

Modules haut avec porte.
2 portes.
2 étagères.

Availability / disponibilidad / disponibilité:

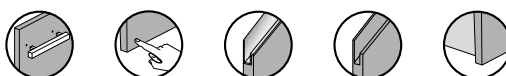

35 depth / profundidad / profondeur

SAP	Code Código Code	Width Ancho Largeur	Opening Apertura Ouverture											
				0	1	2	3	4	5	6	7	8	9	10
700020997	AP 0238	76,2	-	363	435	-	500	543	593	-	667	-	-	-
700020998	AP 0238	80	-	366	439	-	506	545	594	-	669	-	-	-
700020999	AP 0238	90	-	384	467	-	540	590	641	-	726	-	-	-
700021000	AP 0238	100	-	434	518	-	599	648	702	-	795	-	-	-
700021001	AP 0238	120	-	456	547	-	636	682	739	-	832	-	-	-

61 depth / profundidad / profondeur

SAP	Code Código Code	Width Ancho Largeur	Opening Apertura Ouverture											
				0	1	2	3	4	5	6	7	8	9	10
700021002	AP 0239	76,2	-	430	499	-	571	623	665	-	741	-	-	-
700021003	AP 0239	80	-	435	505	-	579	627	673	-	745	-	-	-
700021004	AP 0239	90	-	450	530	-	610	659	712	-	784	-	-	-
700021005	AP 0239	100	-	504	586	-	674	721	777	-	857	-	-	-
700021006	AP 0239	120	-	540	627	-	718	770	828	-	922	-	-	-

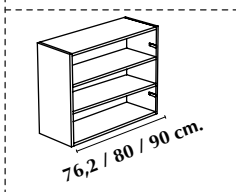
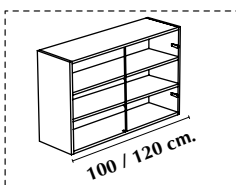

Wall units
Módulos altos
Modules hauts

Wall unit with door
Módulo alto con puerta
Module haut avec porte

H.72

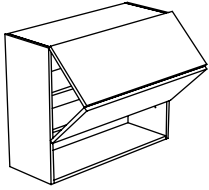

Wall unit with door.
1 flap door.
2 shelves.

Módulo alto con puerta.
1 puerta abatible.
2 baldas.

Modules haut avec porte.
1 porte rabattable.
2 étagères.

Availability / disponibilidad / disponibilité:

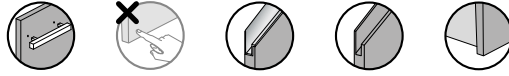

35 depth / profundidad / profondeur

SAP	Code Código Code	Width Ancho Largeur	Opening Apertura Ouverture											
				0	1	2	3	4	5	6	7	8	9	10
700021007	AA 0240	30	-	520	568	-	634	664	683	-	729	-	-	-
700021008	AA 0240	40	-	537	588	-	659	688	715	-	763	-	-	-
700021009	AA 0240	45	-	545	597	-	670	699	727	-	778	-	-	-
700021010	AA 0240	50	-	549	603	-	672	706	735	-	782	-	-	-
700021011	AA 0240	60	-	554	617	-	685	718	748	-	810	-	-	-
700021012	AA 0240	76,2	-	571	645	-	714	747	778	-	836	-	-	-
700021013	AA 0240	80	-	574	650	-	720	750	781	-	844	-	-	-
700021014	AA 0240	90	-	608	693	-	769	799	832	-	874	-	-	-
700021015	AA 0240	100	-	658	746	-	829	859	893	-	975	-	-	-
700021016	AA 0240	120	-	689	785	-	876	913	942	-	1019	-	-	-

61 depth / profundidad / profondeur

SAP	Code Código Code	Width Ancho Largeur	Opening Apertura Ouverture											
				0	1	2	3	4	5	6	7	8	9	10
700021017	AA 0241	30	-	562	613	-	678	707	727	-	775	-	-	-
700021018	AA 0241	40	-	578	638	-	696	731	759	-	808	-	-	-
700021019	AA 0241	45	-	588	649	-	709	744	773	-	825	-	-	-
700021020	AA 0241	50	-	594	657	-	719	753	783	-	839	-	-	-
700021021	AA 0241	60	-	618	684	-	751	784	817	-	880	-	-	-
700021022	AA 0241	76,2	-	638	711	-	784	825	851	-	917	-	-	-
700021023	AA 0241	80	-	643	717	-	792	826	855	-	919	-	-	-
700021024	AA 0241	90	-	674	758	-	838	868	902	-	978	-	-	-
700021025	AA 0241	100	-	728	815	-	902	941	977	-	1051	-	-	-
700021026	AA 0241	120	-	773	867	-	964	1002	1040	-	1129	-	-	-

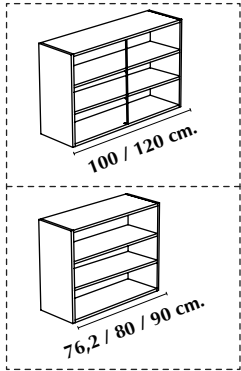

Wall units
Módulos altos
Modules hauts

Wall corner unit
Módulo alto rinconero
Module haut encoignure

H.72

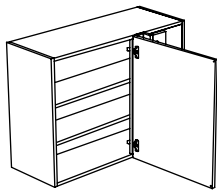

Wall straight corner unit.
1 door.
2 shelves.
1 standard corner filler, 10x10 cm.

Módulo alto rinconero recto.
1 puerta.
2 baldas.
1 regleta de rincón estándar de 10x10 cm.

Module haut encoignure droite.
1 porte.
2 étagères.
1 fileur d'encoignure standard, 10x10 cm.

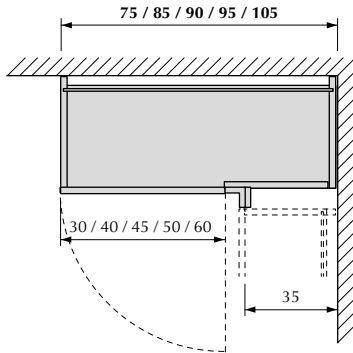

Availability / disponibilidad / disponibilité:

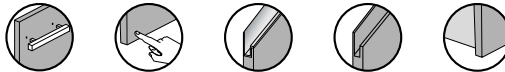

35 depth / profundidad / profondeur

SAP	Code Código Code	Width Ancho Largeur	Opening Apertura Ouverture	0	1	2	3	4	5	6	7	8	9	10
				700021027	ARR 0242	75	L / R	463	531	-	587	617	642	-
700021028	ARR 0242	85	L / R	472	543	-	602	632	658	-	716	-	-	-
700021029	ARR 0242	90	L / R	486	562	-	624	655	684	-	746	-	-	-
700021030	ARR 0242	95	L / R	490	568	-	632	662	692	-	758	-	-	-
700021031	ARR 0242	105	L / R	503	585	-	653	683	714	-	786	-	-	-

H.72

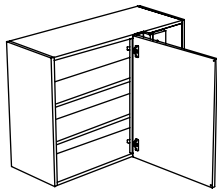

Wall straight corner unit.
1 door.
2 shelves.
1 corner filler with raised door profile, 4x4 cm.

Módulo alto rinconero recto.
1 puerta.
2 baldas.
1 regleta de rincón con perfil de puerta de 4x4 cm.

Module haut encoignure droite.
1 porte.
2 étagères.
1 Fileur d'encoignure avec profilé de porte, 4x4 cm.

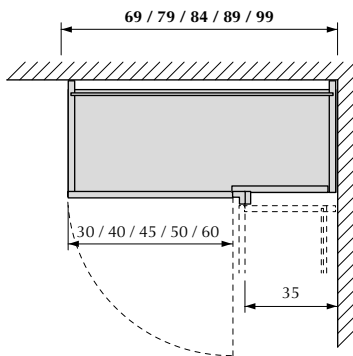

Availability / disponibilidad / disponibilité:

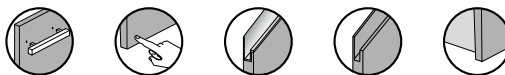

35 depth / profundidad / profondeur

SAP	Code Código Code	Width Ancho Largeur	Opening Apertura Ouverture	0	1	2	3	4	5	6	7	8	9	10
				700021292	ARR 0242	69	L / R	458	526	-	604	645	680	-
700021293	ARR 0242	79	L / R	467	538	-	620	659	696	-	770	-	-	-
700021294	ARR 0242	84	L / R	471	547	-	631	677	719	-	789	-	-	-
700021295	ARR 0242	89	L / R	478	556	-	637	682	723	-	805	-	-	-
700021296	ARR 0242	99	L / R	493	575	-	654	703	747	-	820	-	-	-

Wall units
Módulos altos
Modules hauts

Wall unit for extractor
Módulo alto para extractor
Module haut pour hotte

H.72

Wall unit for extractor.
1 fixed door.
Available in all models but without handle, except: See availability.

Módulo alto para extractor.
1 puerta fija.
Disponibile en todos los modelos, pero sin tirador, excepto: Ver disponibilidad.

Module haut pour hotte.
1 porte fixe.
Disponibile sur tous les modèles mais dispans poignée, à l'exception: Voir la disponibilité

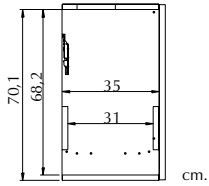
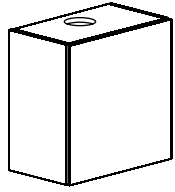

Availability / disponibilidad / disponibilité:

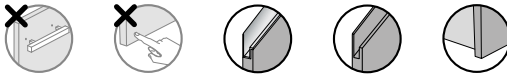

35 depth / profundidad / profondeur														
SAP	Code Código Code	Width Ancho Largeur	Opening Apertura Ouverture	0	1	2	3	4	5	6	7	8	9	10
700021032	AE 0244	60	-	303	351	-	393	419	449	-	497	-	-	-
700021033	AE 0244	90	-	324	386	-	439	469	504	-	562	-	-	-
700021034	AE 0244	120	-	342	415	-	479	512	545	-	610	-	-	-

61 depth / profundidad / profondeur														
SAP	Code Código Code	Width Ancho Largeur	Opening Apertura Ouverture	0	1	2	3	4	5	6	7	8	9	10
700021035	AE 0245	60	-	345	392	-	438	464	495	-	543	-	-	-
700021036	AE 0245	90	-	366	427	-	483	518	549	-	607	-	-	-
700021037	AE 0245	120	-	396	468	-	536	570	603	-	680	-	-	-

H.72

Wall unit for extractor.
2 fixed doors.
Available in all models but without handle, except: See availability.

Módulo alto para extractor.
2 puertas fijas.
Disponibile en todos los modelos, pero sin tirador, excepto: Ver disponibilidad.

Module haut pour hotte.
2 portes fixes.
Disponibile sur tous les modèles mais dispans poignée, à l'exception: Voir la disponibilité

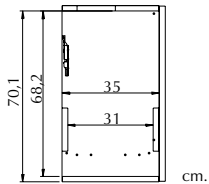
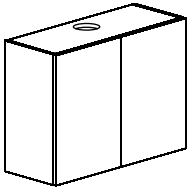

Availability / disponibilidad / disponibilité:

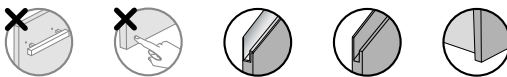

35 depth / profundidad / profondeur														
SAP	Code Código Code	Width Ancho Largeur	Opening Apertura Ouverture	0	1	2	3	4	5	6	7	8	9	10
700021038	AE 0246	90	-	334	419	-	491	537	577	-	646	-	-	-
700021039	AE 0246	120	-	352	447	-	527	574	629	-	719	-	-	-

61 depth / profundidad / profondeur														
SAP	Code Código Code	Width Ancho Largeur	Opening Apertura Ouverture	0	1	2	3	4	5	6	7	8	9	10
700021040	AE 0247	90	-	376	459	-	531	581	633	-	717	-	-	-
700021041	AE 0247	120	-	406	508	-	584	631	687	-	778	-	-	-

H.72

Wall unit for extractor.
1 flap door.
1 shelf.
Variable height.

Módulo alto para extractor.
1 puerta abatible.
1 balda.
Altura variable.

Module haut pour hotte.
1 porte rabattable.
1 étagère.
Hauteur variable.

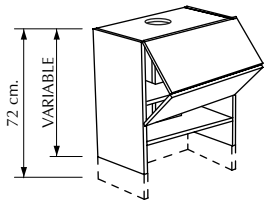

Availability / disponibilidad / disponibilité:

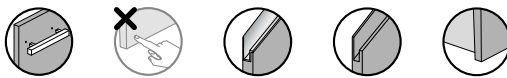

35 depth / profundidad / profondeur														
SAP	Code Código Code	Width Ancho Largeur	Opening Apertura Ouverture	0	1	2	3	4	5	6	7	8	9	10
700021042	AE 0248	60	-	693	731	-	801	832	864	-	929	-	-	-
700021043	AE 0248	90	-	733	784	-	867	903	940	-	1016	-	-	-
700021044	AE 0248	120	-	773	835	-	930	967	1005	-	1102	-	-	-

61 depth / profundidad / profondeur														
SAP	Code Código Code	Width Ancho Largeur	Opening Apertura Ouverture	0	1	2	3	4	5	6	7	8	9	10
700021045	AE 0249	60	-	744	781	-	855	887	919	-	985	-	-	-
700021046	AE 0249	90	-	790	841	-	927	964	1001	-	1079	-	-	-
700021047	AE 0249	120	-	842	903	-	1002	1040	1078	-	1177	-	-	-

Wall units
Módulos altos
Modules hauts

Wall unit for extractor
Módulo alto para extractor
Module haut pour hotte

H.72

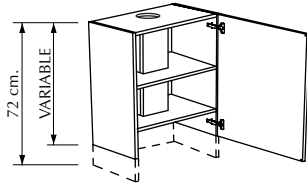

Wall unit for extractor.
1 door.
1 shelf.
Variable height.

Módulo alto para extractor.
1 puerta.
1 balda.
Altura variable.

Module haut pour hotte.
1 porte.
1 étagère.
Hauteur variable.

Availability / disponibilidad / disponibilité:

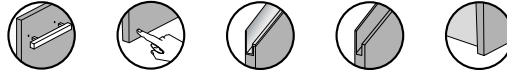

35 depth / profundidad / profondeur

SAP	Code Código Code	Width Ancho Largeur	Opening Apertura Ouverture	0	1	2	3	4	5	6	7	8	9	10
				700021048	AE 0250	60	-	490	533	-	589	618	648	-

61 depth / profundidad / profondeur

SAP	Code Código Code	Width Ancho Largeur	Opening Apertura Ouverture	0	1	2	3	4	5	6	7	8	9	10
				700021051	AE 0251	60	-	541	583	-	643	673	703	-

H.72

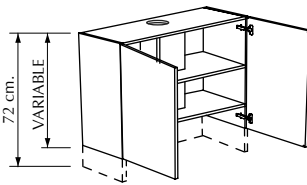

Wall unit for extractor.
2 doors.
1 shelf.
Variable height.

Módulo alto para extractor.
2 puertas.
1 balda.
Altura variable.

Module haut pour hotte.
2 portes.
1 étagère.
Hauteur variable.

Availability / disponibilidad / disponibilité:

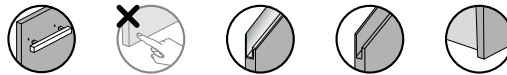

35 depth / profundidad / profondeur

SAP	Code Código Code	Width Ancho Largeur	Opening Apertura Ouverture	0	1	2	3	4	5	6	7	8	9	10
				700021049	AE 0250	90	-	530	617	-	687	723	782	-
700021050	AE 0250	120	-	561	658	-	740	781	835	-	936	-	-	-

61 depth / profundidad / profondeur

SAP	Code Código Code	Width Ancho Largeur	Opening Apertura Ouverture	0	1	2	3	4	5	6	7	8	9	10
				700021052	AE 0251	90	-	587	673	-	747	785	842	-
700021053	AE 0251	120	-	630	725	-	812	848	907	-	1020	-	-	-

Wall units
Módulos altos
Modules hauts

Wall unit for over-the-range microwave
Módulo alto para horno-microondas-campana.
Module haut pour four micro-ondes hotte

H.72

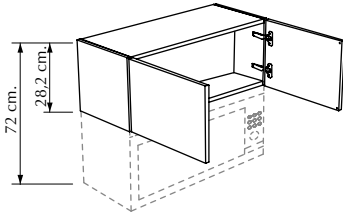

Wall unit for over-the-range microwave.
2 doors.
1 removable back panel.

Módulo alto para horno-microondas-campana.
2 puertas.
1 trasera desmontable.

Module haut pour four micro-ondes hotte.
2 portes.
1 panneau arrière démontable.

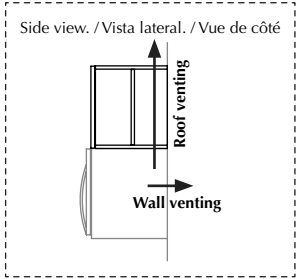

Availability / disponibilidad / disponibilité:

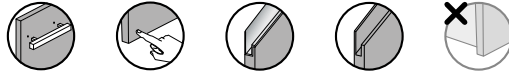

35 depth / profundidad / profondeur

SAP	Code Código Code	Width Ancho Largeur	Opening Apertura Ouverture	0	1	2	3	4	5	6	7	8	9	10
				700021273	AE 0319	76,2	-	276	334	-	394	426	462	-

H.72

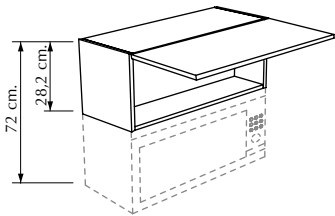

Wall unit for over-the-range microwave.
1 flap door.
1 removable back panel.

Módulo alto para horno-microondas-campana.
1 puerta abatible.
1 trasera desmontable.

Module haut pour four micro-ondes hotte.
1 porte rabattable.
1 panneau arrière démontable.

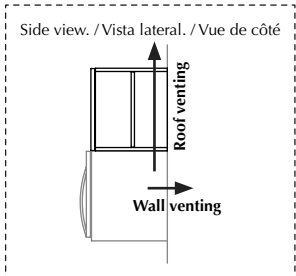

Availability / disponibilidad / disponibilité:

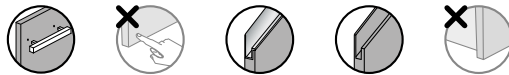

35 depth / profundidad / profondeur

SAP	Code Código Code	Width Ancho Largeur	Opening Apertura Ouverture	0	1	2	3	4	5	6	7	8	9	10
				700021269	AE 0315	76,2	-	338	365	-	406	436	458	-

Wall units
Módulos altos
Modules hauts

Wall unit for plate draining rack
Módulo alto para escurreplatos
Module haut pour égouttoir

H.72

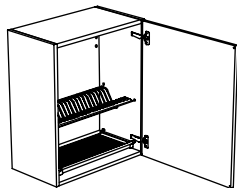

Wall unit for plate draining rack.
1 door.
1 glass draining tray.
1 plate draining tray.
1 water collecting tray.

Módulo alto para escurreplatos.
1 puerta.
1 bandeja escurre-vasos.
1 bandeja escurre-platos.
1 bandeja recoge-agua.

Module haut pour égouttoir.
1 porte.
1 plateau égouttoir verres.
1 plateau égouttoir assiettes.
1 plateau dévidoir.

Availability / disponibilidad / disponibilité:

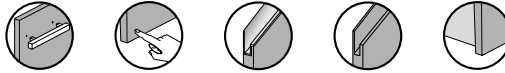

35 depth / profundidad / profondeur

SAP	Code Código Code	Width Ancho Largeur	Opening Apertura Ouverture	0	1	2	3	4	5	6	7	8	9	10
				700021054	AEQ 0252	45	L / R	374	408	-	458	486	515	-
700021055	AEQ 0252	50	L / R	382	418	-	470	497	527	-	580	-	-	-
700021056	AEQ 0252	60	L / R	399	438	-	494	520	552	-	613	-	-	-

61 depth / profundidad / profondeur

SAP	Code Código Code	Width Ancho Largeur	Opening Apertura Ouverture	0	1	2	3	4	5	6	7	8	9	10
				700021057	AEQ 0253	45	L / R	412	445	-	498	525	555	-
700021058	AEQ 0253	50	L / R	422	455	-	511	538	569	-	624	-	-	-
700021059	AEQ 0253	60	L / R	451	495	-	548	574	607	-	670	-	-	-

H.72

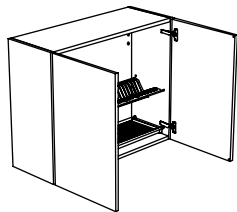

Wall unit for plate draining rack.
2 doors.
1 glass draining tray.
1 plate draining tray.
1 water collecting tray.

Módulo alto para escurreplatos.
2 puertas.
1 bandeja escurre-vasos.
1 bandeja escurre-platos.
1 bandeja recoge-agua.

Module haut pour égouttoir.
2 portes.
1 plateau égouttoir verres.
1 plateau égouttoir assiettes.
1 plateau dévidoir.

Availability / disponibilidad / disponibilité:

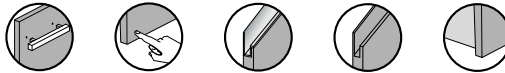

35 depth / profundidad / profondeur







SAP	Code Código Code	Width Ancho Largeur	Opening Apertura Ouverture	0	1	2	3	4	5	6	7	8	9	10
				700021060	AEQ 0254	80	-	445	515	-	590	637	683	-
700021061	AEQ 0254	90	-	470	549	-	630	680	733	-	821	-	-	-

61 depth / profundidad / profondeur

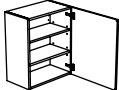
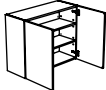
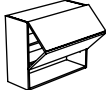
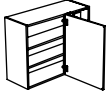
SAP	Code Código Code	Width Ancho Largeur	Opening Apertura Ouverture	0	1	2	3	4	5	6	7	8	9	10
				700021062	AEQ 0255	80	-	503	570	-	651	698	745	-
700021063	AEQ 0255	90	-	524	601	-	688	736	791	-	881	-	-	-

h. 84

Wall units
Módulos altos
Modules hauts

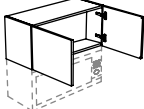
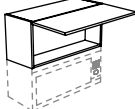
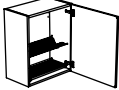
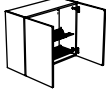
Type of unit Tipo de módulo Type de module	Available measures Medidas disponibles Dimensions disponibles	Available units Módulos disponibles Modules disponibles
<p>p.212 - 213</p> <p>Wall unit with door Módulo alto con puerta Module haut avec porte</p>	<p>Depth / Profundidad / Profondeur (cm.): 35 - 61</p> <p>Width / Ancho / Largeur (cm.): 30 - 40 - 45 - 50 - 60 - 76,2 - 80 - 90 - 100 - 120</p>	 <p>AP 0256 - 0257</p>  <p>AP 0258 - 0259</p>  <p>AP 0260 - 0261</p>
<p>p.214</p> <p>Wall corner unit Módulo alto rinconero Module haut encoignure</p>	<p>Depth / Profundidad / Profondeur (cm.): 35</p> <p>Width / Ancho / Largeur (cm.): 75 - 85 - 90 - 95 - 105</p>	 <p>ARR 0262</p>
<p>p.215 - 217</p> <p>Wall unit for extractor Módulo alto para extractor Module haut pour hotte</p>	<p>Depth / Profundidad / Profondeur (cm.): 35 - 61</p> <p>Width / Ancho / Largeur (cm.): 60 - 90 - 120</p>	 <p>AE 0264 - 0265</p>  <p>AE 0266 - 0267</p>  <p>AE 0268 - 0269</p>  <p>AE 0270 - 0271</p>  <p>AE 0270 - 0271</p>  <p>AE 0320</p>  <p>AE 0316</p>
<p>p.218</p> <p>Wall unit for plate draining rack Módulo alto para escurreplatos Module haut pour égouttoir</p>	<p>Depth / Profundidad / Profondeur (cm.): 35 - 61</p> <p>Width / Ancho / Largeur (cm.): 45 - 50 - 60 - 80 - 90</p>	 <p>AEQ 0272 - 0273</p>  <p>AEQ 0274 - 0275</p>

Wall units
Módulos altos
Modules hauts

Wall unit with door
Módulo alto con puerta
Module haut avec porte

H.84

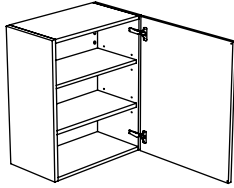

Wall unit with door.
1 door.
2 shelves.

Módulo alto con puerta.
1 puerta.
2 baldas.

Modules haut avec porte.
1 porte.
2 étagères.

Availability / disponibilidad / disponibilité:

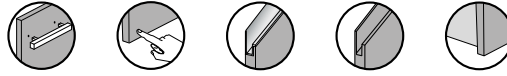

35 depth / profundidad / profondeur

SAP	Code Código Code	Width Ancho Largeur	Opening Apertura Ouverture											
				0	1	2	3	4	5	6	7	8	9	10
700021064	AP 0256	30	L / R	306	336	-	380	403	428	-	468	-	-	-
700021065	AP 0256	40	L / R	323	360	-	409	432	461	-	510	-	-	-
700021066	AP 0256	45	L / R	327	366	-	414	439	470	-	523	-	-	-
700021067	AP 0256	50	L / R	331	372	-	422	447	479	-	536	-	-	-
700021068	AP 0256	60	L / R	340	384	-	439	467	496	-	551	-	-	-

61 depth / profundidad / profondeur

SAP	Code Código Code	Width Ancho Largeur	Opening Apertura Ouverture											
				0	1	2	3	4	5	6	7	8	9	10
700021069	AP 0257	30	L / R	350	378	-	423	449	475	-	516	-	-	-
700021070	AP 0257	40	L / R	366	401	-	451	477	508	-	558	-	-	-
700021071	AP 0257	45	L / R	372	409	-	461	487	518	-	573	-	-	-
700021072	AP 0257	50	L / R	379	417	-	472	497	529	-	583	-	-	-
700021073	AP 0257	60	L / R	403	445	-	505	528	563	-	620	-	-	-

H. 84

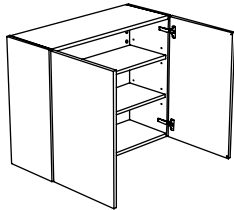

Wall unit with door.
2 doors.
2 shelves.

Módulo alto con puerta.
2 puertas.
2 baldas.

Modules haut avec porte.
2 portes.
2 étagères.

Availability / disponibilidad / disponibilité:

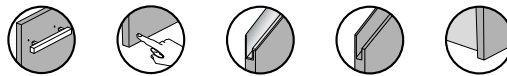

35 depth / profundidad / profondeur

SAP	Code Código Code	Width Ancho Largeur	Opening Apertura Ouverture											
				0	1	2	3	4	5	6	7	8	9	10
700021074	AP 0258	76,2	-	372	456	-	522	569	617	-	699	-	-	-
700021075	AP 0258	80	-	376	460	-	533	581	635	-	722	-	-	-
700021076	AP 0258	90	-	391	479	-	558	604	660	-	755	-	-	-
700021077	AP 0258	100	-	444	534	-	622	665	725	-	830	-	-	-
700021078	AP 0258	120	-	470	568	-	665	705	769	-	892	-	-	-

61 depth / profundidad / profondeur

SAP	Code Código Code	Width Ancho Largeur	Opening Apertura Ouverture											
				0	1	2	3	4	5	6	7	8	9	10
700021079	AP 0259	76,2	-	442	522	-	601	652	703	-	789	-	-	-
700021080	AP 0259	80	-	447	529	-	609	656	711	-	793	-	-	-
700021081	AP 0259	90	-	460	545	-	625	676	733	-	816	-	-	-
700021082	AP 0259	100	-	517	604	-	692	742	802	-	894	-	-	-
700021083	AP 0259	120	-	556	650	-	749	795	860	-	959	-	-	-

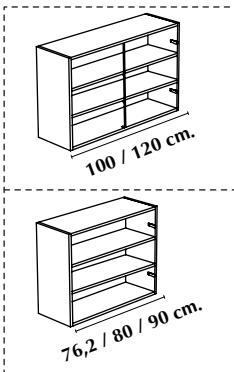

Wall units
Módulos altos
Modules hauts

Wall unit with door
Módulo alto con puerta
Module haut avec porte

H.84

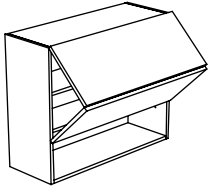

Wall unit with door.
1 flap door.
2 shelves.

Módulo alto con puerta.
1 puerta abatible.
2 baldas.

Modules haut avec porte.
1 porte rabattable.
2 étagères.

Availability / disponibilidad / disponibilité:

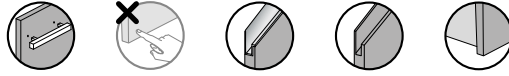

35 depth / profundidad / profondeur

SAP	Code Código Code	Width Ancho Largeur	Opening Apertura Ouverture											
				0	1	2	3	4	5	6	7	8	9	10
700021084	AA 0260	30	-	531	590	-	643	678	698	-	748	-	-	-
700021085	AA 0260	40	-	547	600	-	668	701	731	-	783	-	-	-
700021086	AA 0260	45	-	552	617	-	677	709	740	-	796	-	-	-
700021087	AA 0260	50	-	556	624	-	686	717	749	-	810	-	-	-
700021088	AA 0260	60	-	562	634	-	700	730	757	-	817	-	-	-
700021089	AA 0260	76,2	-	582	667	-	741	771	803	-	876	-	-	-
700021090	AA 0260	80	-	595	681	-	757	785	820	-	896	-	-	-
700021091	AA 0260	90	-	625	716	-	798	832	869	-	929	-	-	-
700021092	AA 0260	100	-	678	772	-	861	895	935	-	1020	-	-	-
700021093	AA 0260	120	-	704	807	-	905	939	980	-	1061	-	-	-

61 depth / profundidad / profondeur

SAP	Code Código Code	Width Ancho Largeur	Opening Apertura Ouverture											
				0	1	2	3	4	5	6	7	8	9	10
700021094	AA 0261	30	-	575	633	-	695	724	752	-	797	-	-	-
700021095	AA 0261	40	-	591	642	-	713	747	777	-	831	-	-	-
700021096	AA 0261	45	-	597	663	-	728	760	793	-	855	-	-	-
700021097	AA 0261	50	-	604	670	-	735	767	800	-	862	-	-	-
700021098	AA 0261	60	-	628	698	-	769	799	827	-	905	-	-	-
700021099	AA 0261	76,2	-	652	735	-	814	844	877	-	952	-	-	-
700021100	AA 0261	80	-	666	751	-	832	868	904	-	974	-	-	-
700021101	AA 0261	90	-	694	783	-	870	904	943	-	1021	-	-	-
700021102	AA 0261	100	-	751	843	-	938	972	1013	-	1099	-	-	-
700021103	AA 0261	120	-	790	891	-	995	1037	1083	-	1174	-	-	-

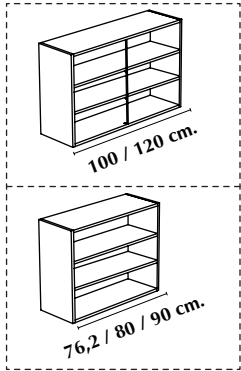

Wall units
Módulos altos
Modules hauts

Wall corner unit
Módulo alto rinconero
Module haut encoignure

H.84

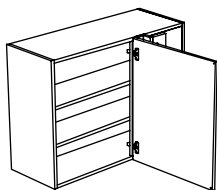

Wall straight corner unit.
1 door.
2 shelves.
1 standard corner filler, 10x10 cm.

Módulo alto rinconero recto.
1 puerta.
2 baldas.
1 regleta de rincón estándar de 10x10 cm.

Module haut encoignure droite.
1 porte.
2 étagères.
1 fileur d'encoignure standard, 10x10 cm.

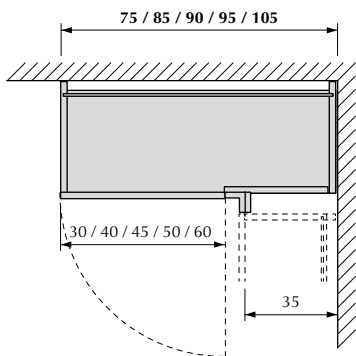

Availability / disponibilidad / disponibilité:

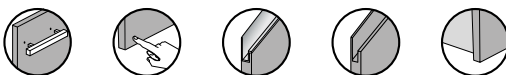

35 depth / profundidad / profondeur

SAP	Code Código Code	Width Ancho Largeur	Opening Apertura Ouverture	0	1	2	3	4	5	6	7	8	9	10
				700021104	ARR 0262	75	L / R	477	549	-	609	631	664	-
700021105	ARR 0262	85	L / R	486	565	-	629	658	689	-	756	-	-	-
700021106	ARR 0262	90	L / R	497	578	-	645	673	705	-	776	-	-	-
700021107	ARR 0262	95	L / R	501	584	-	653	680	714	-	774	-	-	-
700021108	ARR 0262	105	L / R	515	602	-	676	702	737	-	820	-	-	-

H.84

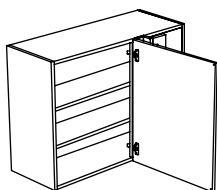

Wall straight corner unit.
1 door.
2 shelves.
1 corner filler with raised door profile, 4x4 cm.

Módulo alto rinconero recto.
1 puerta.
2 baldas.
1 regleta de rincón con perfil de puerta de 4x4 cm.

Module haut encoignure droite.
1 porte.
2 étagères.
1 Fileur d'encoignure avec profilé de porte, 4x4 cm.

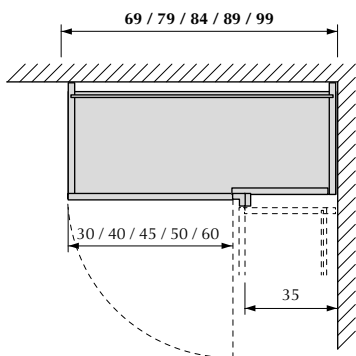

Availability / disponibilidad / disponibilité:

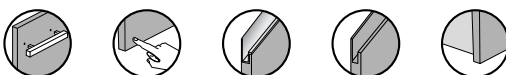

35 depth / profundidad / profondeur

SAP	Code Código Code	Width Ancho Largeur	Opening Apertura Ouverture	0	1	2	3	4	5	6	7	8	9	10
				700021297	ARR 0262	69	L / R	469	532	-	606	655	700	-
700021298	ARR 0262	79	L / R	481	551	-	630	678	728	-	811	-	-	-
700021299	ARR 0262	84	L / R	485	557	-	638	692	737	-	823	-	-	-
700021300	ARR 0262	89	L / R	489	563	-	647	699	745	-	836	-	-	-
700021301	ARR 0262	99	L / R	505	582	-	671	721	770	-	853	-	-	-

Wall units
Módulos altos
Modules hauts

Wall unit for extractor
Módulo alto para extractor
Module haut pour hotte

H.84

Wall unit for extractor.
1 fixed door.
Available in all models but without handle, except: See availability.

Módulo alto para extractor.
1 puerta fija.
Disponibile en todos los modelos, pero sin tirador, excepto: Ver disponibilidad.

Module haut pour hotte.
1 porte fixe.
Disponibile sur tous les modèles mais dispans poignée, à l'exception: Voir la disponibilité

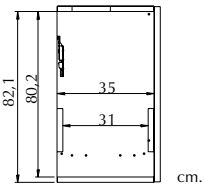
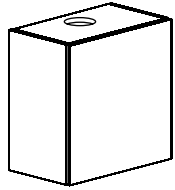

Availability / disponibilidad / disponibilité:

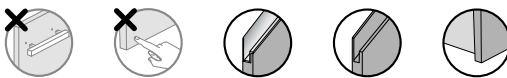

35 depth / profundidad / profondeur														
SAP	Code Código Code	Width Ancho Largeur	Opening Apertura Ouverture	0	1	2	3	4	5	6	7	8	9	10
700021109	AE 0264	60	-	307	358	-	404	428	452	-	501	-	-	-
700021110	AE 0264	90	-	328	395	-	453	484	519	-	586	-	-	-
700021111	AE 0264	120	-	346	429	-	491	531	575	-	652	-	-	-

61 depth / profundidad / profondeur														
SAP	Code Código Code	Width Ancho Largeur	Opening Apertura Ouverture	0	1	2	3	4	5	6	7	8	9	10
700021112	AE 0265	60	-	352	402	-	452	479	509	-	564	-	-	-
700021113	AE 0265	90	-	372	438	-	500	532	566	-	634	-	-	-
700021114	AE 0265	120	-	403	485	-	559	592	636	-	719	-	-	-

H.84

Wall unit for extractor.
2 fixed doors.
Available in all models but without handle, except: See availability.

Módulo alto para extractor.
2 puertas fijas.
Disponibile en todos los modelos, pero sin tirador, excepto: Ver disponibilidad.

Module haut pour hotte.
2 portes fixes.
Disponibile sur tous les modèles mais dispans poignée, à l'exception: Voir la disponibilité

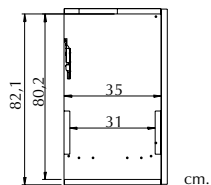
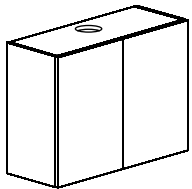

Availability / disponibilidad / disponibilité:

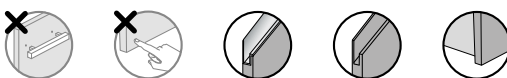

35 depth / profundidad / profondeur														
SAP	Code Código Code	Width Ancho Largeur	Opening Apertura Ouverture	0	1	2	3	4	5	6	7	8	9	10
700021115	AE 0266	90	-	338	435	-	502	548	592	-	671	-	-	-
700021116	AE 0266	120	-	356	458	-	540	586	636	-	737	-	-	-

61 depth / profundidad / profondeur														
SAP	Code Código Code	Width Ancho Largeur	Opening Apertura Ouverture	0	1	2	3	4	5	6	7	8	9	10
700021117	AE 0267	90	-	382	471	-	544	595	651	-	732	-	-	-
700021118	AE 0267	120	-	413	513	-	599	646	695	-	798	-	-	-

H.84

Wall unit for extractor.
1 flap door.
1 shelf.
Variable height.

Módulo alto para extractor.
1 puerta abatible.
1 balda.
Altura variable.

Module haut pour hotte.
1 porte rabattable.
1 étagère.
Hauteur variable.

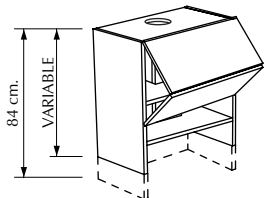

Availability / disponibilidad / disponibilité:

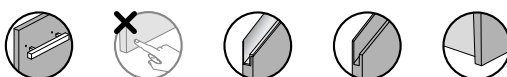

35 depth / profundidad / profondeur														
SAP	Code Código Code	Width Ancho Largeur	Opening Apertura Ouverture	0	1	2	3	4	5	6	7	8	9	10
700021119	AE 0268	60	-	708	750	-	824	856	888	-	951	-	-	-
700021120	AE 0268	90	-	759	816	-	905	941	978	-	1055	-	-	-
700021121	AE 0268	120	-	803	874	-	978	1019	1062	-	1151	-	-	-

61 depth / profundidad / profondeur														
SAP	Code Código Code	Width Ancho Largeur	Opening Apertura Ouverture	0	1	2	3	4	5	6	7	8	9	10
700021122	AE 0269	60	-	762	803	-	881	913	946	-	1010	-	-	-
700021123	AE 0269	90	-	819	874	-	968	1005	1042	-	1131	-	-	-
700021124	AE 0269	120	-	863	933	-	1041	1083	1126	-	1215	-	-	-

Wall units
Módulos altos
Modules hauts

Wall unit for extractor
Módulo alto para extractor
Module haut pour hotte

H.84

Wall unit for extractor.
1 door.
1 shelf.
Variable height.

Módulo alto para extractor.
1 puerta.
1 balda.
Altura variable.

Module haut pour hotte.
1 porte.
1 étagère.
Hauteur variable.

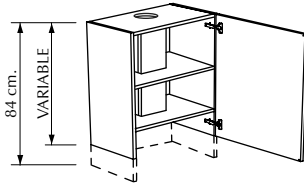

Availability / disponibilidad / disponibilité:

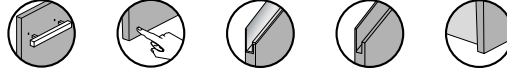

35 depth / profundidad / profondeur

SAP	Code Código Code	Width Ancho Largeur	Opening Apertura Ouverture	0	1	2	3	4	5	6	7	8	9	10
				700021125	AE 0270	60	-	504	551	-	611	640	671	-

61 depth / profundidad / profondeur

SAP	Code Código Code	Width Ancho Largeur	Opening Apertura Ouverture	0	1	2	3	4	5	6	7	8	9	10
				700021128	AE 0271	60	-	558	603	-	667	697	728	-

H.84

Wall unit for extractor.
2 doors.
1 shelf.
Variable height.

Módulo alto para extractor.
2 puertas.
1 balda.
Altura variable.

Module haut pour hotte.
2 portes.
1 étagère.
Hauteur variable.

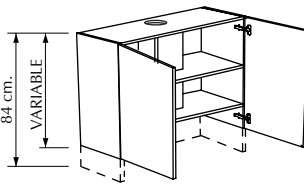

Availability / disponibilidad / disponibilité:

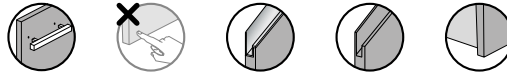

35 depth / profundidad / profondeur

SAP	Code Código Code	Width Ancho Largeur	Opening Apertura Ouverture	0	1	2	3	4	5	6	7	8	9	10
				700021126	AE 0270	90	-	545	638	-	714	753	809	-
700021127	AE 0270	120	-	578	682	-	771	808	867	-	973	-	-	-

61 depth / profundidad / profondeur

SAP	Code Código Code	Width Ancho Largeur	Opening Apertura Ouverture	0	1	2	3	4	5	6	7	8	9	10
				700021129	AE 0271	90	-	605	696	-	777	818	872	-
700021130	AE 0271	120	-	649	752	-	846	902	960	-	1069	-	-	-

Wall units
Módulos altos
Modules hauts

Wall unit for over-the-range microwave
Módulo alto para horno-microondas-campana.
Module haut pour four micro-ondes hotte

H.84

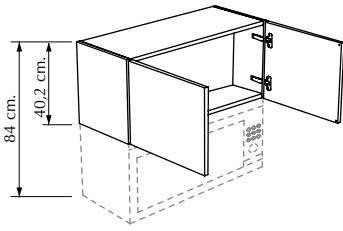

Wall unit for over-the-range microwave.
2 doors.
1 removable back panel.

Módulo alto para horno-microondas-campana.
2 puertas.
1 trasera desmontable.

Module haut pour four micro-ondes hotte.
2 portes.
1 panneau arrière démontable.

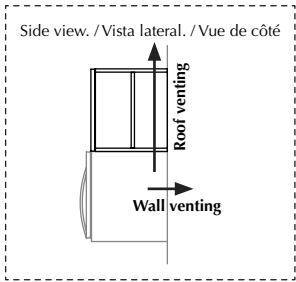

Availability / disponibilidad / disponibilité:

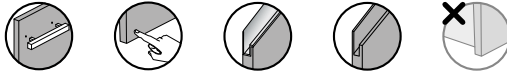

35 depth / profundidad / profondeur

SAP	Code Código Code	Width Ancho Largeur	Opening Apertura Ouverture	0	1	2	3	4	5	6	7	8	9	10
				700021274	AE 0320	76,2	-	286	349	-	407	442	478	-

H.84

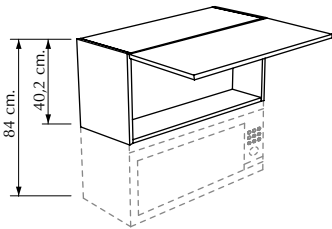

Wall unit for over-the-range microwave.
1 flap door.
1 removable back panel.

Módulo alto para horno-microondas-campana.
1 puerta abatible.
1 trasera desmontable.

Module haut pour four micro-ondes hotte.
1 porte rabattable.
1 panneau arrière démontable.

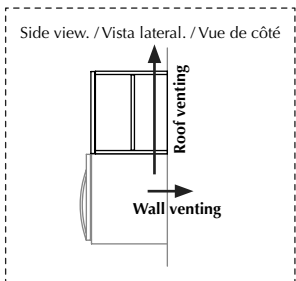

Availability / disponibilidad / disponibilité:

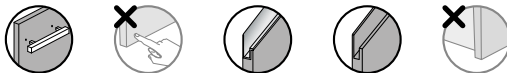

35 depth / profundidad / profondeur

SAP	Code Código Code	Width Ancho Largeur	Opening Apertura Ouverture	0	1	2	3	4	5	6	7	8	9	10
				700021270	AE 0316	76,2	-	350	384	-	435	462	487	-

Wall units
Módulos altos
Modules hauts

Wall unit for plate draining rack
Módulo alto para escurreplatos
Module haut pour égouttoir

H.84

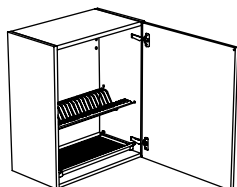

Wall unit for plate draining rack.
1 door.
1 glass draining tray.
1 plate draining tray.
1 water collecting tray.

Módulo alto para escurreplatos.
1 puerta.
1 bandeja escurre-vasos.
1 bandeja escurre-platos.
1 bandeja recoge-agua.

Module haut pour égouttoir.
1 porte.
1 plateau égouttoir verres.
1 plateau égouttoir assiettes.
1 plateau dévidoir.

Availability / disponibilidad / disponibilité:

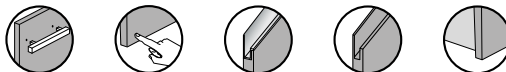

35 depth / profundidad / profondeur

SAP	Code Código Code	Width Ancho Largeur	Opening Apertura Ouverture	0	1	2	3	4	5	6	7	8	9	10
				700021131	AEQ 0272	45	L / R	380	424	-	469	495	527	-
700021132	AEQ 0272	50	L / R	388	434	-	482	511	539	-	588	-	-	-
700021133	AEQ 0272	60	L / R	405	455	-	508	536	566	-	622	-	-	-

61 depth / profundidad / profondeur

SAP	Code Código Code	Width Ancho Largeur	Opening Apertura Ouverture	0	1	2	3	4	5	6	7	8	9	10
				700021134	AEQ 0273	45	L / R	420	463	-	512	537	569	-
700021135	AEQ 0273	50	L / R	430	474	-	525	555	584	-	633	-	-	-
700021136	AEQ 0273	60	L / R	459	507	-	564	593	623	-	681	-	-	-

H.84

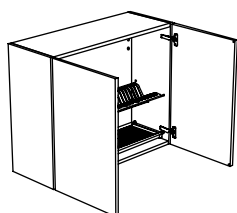

Wall unit for plate draining rack.
2 doors.
1 glass draining tray.
1 plate draining tray.
1 water collecting tray.

Módulo alto para escurreplatos.
2 puertas.
1 bandeja escurre-vasos.
1 bandeja escurre-platos.
1 bandeja recoge-agua.

Module haut pour égouttoir.
2 portes.
1 plateau égouttoir verres.
1 plateau égouttoir assiettes.
1 plateau dévidoir.

Availability / disponibilidad / disponibilité:

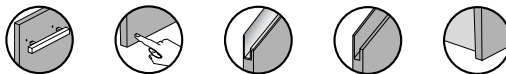

35 depth / profundidad / profondeur







SAP	Code Código Code	Width Ancho Largeur	Opening Apertura Ouverture	0	1	2	3	4	5	6	7	8	9	10
				700021137	AEQ 0274	80	-	455	536	-	617	664	720	-
700021138	AEQ 0274	90	-	477	562	-	648	694	751	-	850	-	-	-

61 depth / profundidad / profondeur

SAP	Code Código Code	Width Ancho Largeur	Opening Apertura Ouverture	0	1	2	3	4	5	6	7	8	9	10
				700021139	AEQ 0275	80	-	515	594	-	681	727	784	-
700021140	AEQ 0275	90	-	534	616	-	708	753	804	-	904	-	-	-

h. 96

Wall units
Módulos altos
Modules hauts

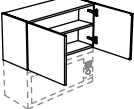
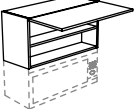
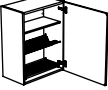
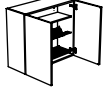
Type of unit Tipo de módulo Type de module	Available measures Medidas disponibles Dimensions disponibles	Available units Módulos disponibles Modules disponibles
<p>p.222</p> <p>Wall unit with door Módulo alto con puerta Module haut avec porte</p>	<p>Depth / Profundidad / Profondeur (cm.): 35 - 61</p> <p>Width / Ancho / Largeur (cm.): 30 - 40 - 45 - 50 - 60 - 76,2 - 80 - 90 - 100 - 120</p>	 <p>AP 0276 - 0277</p>  <p>AP 0278 - 0279</p>
<p>p.223</p> <p>Wall corner unit Módulo alto rinconero Module haut encoignure</p>	<p>Depth / Profundidad / Profondeur (cm.): 35</p> <p>Width / Ancho / Largeur (cm.): 75 - 85 - 90 - 95 - 105</p>	 <p>ARR 0282</p>
<p>p.224 - 226</p> <p>Wall unit for extractor Módulo alto para extractor Module haut pour hotte</p>	<p>Depth / Profundidad / Profondeur (cm.): 35 - 61</p> <p>Width / Ancho / Largeur (cm.): 60 - 90 - 120</p>	 <p>AE 0284 - 0285</p>  <p>AE 0286 - 0287</p>  <p>AE 0290 - 0291</p>  <p>AE 0290 - 0291</p>  <p>AE 0321</p>  <p>AE 0317</p>
<p>p.227</p> <p>Wall unit for plate draining rack Módulo alto para escurreplatos Module haut pour égouttoir</p>	<p>Depth / Profundidad / Profondeur (cm.): 35 - 61</p> <p>Width / Ancho / Largeur (cm.): 45 - 50 - 60 - 80 - 90</p>	 <p>AEQ 0292 - 0293</p>  <p>AEQ 0294 - 0295</p>

Wall units
Módulos altos
Modules hauts

Wall unit with door
Módulo alto con puerta
Module haut avec porte

H.96

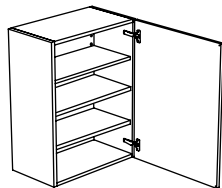

Wall unit with door.
1 door.
3 shelves.

Módulo alto con puerta.
1 puerta.
3 baldas.

Modules haut avec porte.
1 porte.
3 étagères.

Availability / disponibilidad / disponibilité:

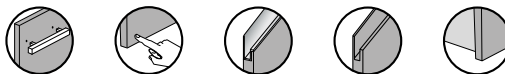

35 depth / profundidad / profondeur

SAP	Code Código Code	Width Ancho Largeur	Opening Apertura Ouverture											
				0	1	2	3	4	5	6	7	8	9	10
700021141	AP 0276	30	L / R	343	373	-	418	444	471	-	515	-	-	-
700021142	AP 0276	40	L / R	362	403	-	451	476	504	-	553	-	-	-
700021143	AP 0276	45	L / R	367	414	-	461	485	509	-	562	-	-	-
700021144	AP 0276	50	L / R	372	421	-	471	493	519	-	577	-	-	-
700021145	AP 0276	60	L / R	383	436	-	491	516	544	-	606	-	-	-

61 depth / profundidad / profondeur

SAP	Code Código Code	Width Ancho Largeur	Opening Apertura Ouverture											
				0	1	2	3	4	5	6	7	8	9	10
700021146	AP 0277	30	L / R	387	422	-	465	494	513	-	553	-	-	-
700021147	AP 0277	40	L / R	406	449	-	497	526	549	-	600	-	-	-
700021148	AP 0277	45	L / R	413	459	-	509	533	562	-	617	-	-	-
700021149	AP 0277	50	L / R	421	469	-	522	549	575	-	635	-	-	-
700021150	AP 0277	60	L / R	450	502	-	562	587	615	-	679	-	-	-

H. 96

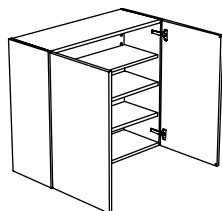

Wall unit with door.
2 doors.
3 shelves.

Módulo alto con puerta.
2 puertas.
3 baldas.

Modules haut avec porte.
2 portes.
3 étagères.

Availability / disponibilidad / disponibilité:

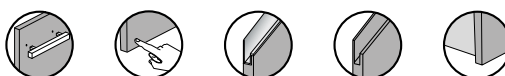

35 depth / profundidad / profondeur

SAP	Code Código Code	Width Ancho Largeur	Opening Apertura Ouverture											
				0	1	2	3	4	5	6	7	8	9	10
700021151	AP 0278	76,2	-	418	509	-	584	632	674	-	766	-	-	-
700021152	AP 0278	80	-	422	514	-	586	635	682	-	770	-	-	-
700021153	AP 0278	90	-	439	536	-	619	660	709	-	799	-	-	-
700021154	AP 0278	100	-	508	607	-	695	747	798	-	891	-	-	-
700021155	AP 0278	120	-	537	651	-	743	791	847	-	958	-	-	-

61 depth / profundidad / profondeur

SAP	Code Código Code	Width Ancho Largeur	Opening Apertura Ouverture											
				0	1	2	3	4	5	6	7	8	9	10
700021156	AP 0279	76,2	-	494	582	-	659	712	761	-	849	-	-	-
700021157	AP 0279	80	-	500	590	-	668	717	764	-	854	-	-	-
700021158	AP 0279	90	-	515	609	-	693	740	789	-	889	-	-	-
700021159	AP 0279	100	-	590	686	-	780	833	892	-	997	-	-	-
700021160	AP 0279	120	-	633	738	-	844	893	949	-	1060	-	-	-

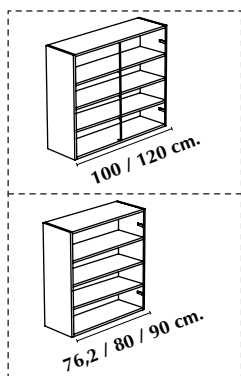

Wall units
Módulos altos
Modules hauts

Wall corner unit
Módulo alto rinconero
Module haut encoignure

H.96

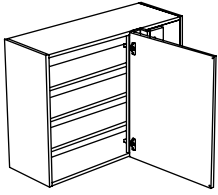

Wall straight corner unit.
1 door.
3 shelves.
1 standard corner filler, 10x10 cm.

Módulo alto rinconero recto.
1 puerta.
3 baldas.
1 regleta de rincón estándar de 10x10 cm.

Module haut encoignure droite.
1 porte.
3 étagères.
1 fileur d'encoignure standard, 10x10 cm.

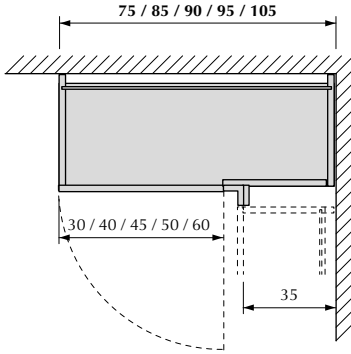

Availability / disponibilidad / disponibilité:

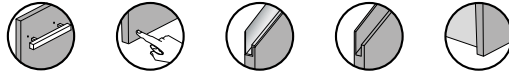

35 depth / profundidad / profondeur

SAP	Code Código Code	Width Ancho Largeur	Opening Apertura Ouverture	0	1	2	3	4	5	6	7	8	9	10
700021181	ARR 0282	75	L / R	527	602	-	668	695	725	-	791	-	-	-
700021182	ARR 0282	85	L / R	537	620	-	692	724	760	-	828	-	-	-
700021183	ARR 0282	90	L / R	549	623	-	709	741	778	-	867	-	-	-
700021184	ARR 0282	95	L / R	555	642	-	718	750	781	-	849	-	-	-
700021185	ARR 0282	105	L / R	576	667	-	750	780	813	-	890	-	-	-

H.96

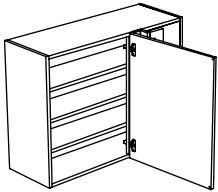

Wall straight corner unit.
1 door.
3 shelves.
1 corner filler with raised door profile,
4x4 cm.

Módulo alto rinconero recto.
1 puerta.
3 baldas.
1 regleta de rincón con perfil de puerta de
4x4 cm.

Module haut encoignure droite.
1 porte.
3 étagères.
1 Fileur d'encoignure avec profilé de porte,
4x4 cm.

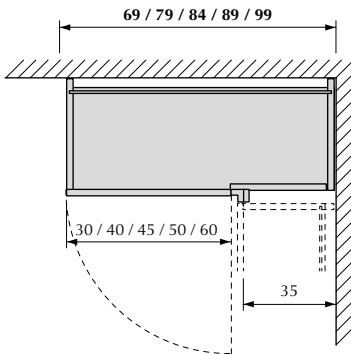

Availability / disponibilidad / disponibilité:

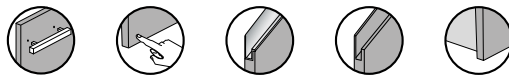

35 depth / profundidad / profondeur

SAP	Code Código Code	Width Ancho Largeur	Opening Apertura Ouverture	0	1	2	3	4	5	6	7	8	9	10
700021302	ARR 0282	69	L / R	521	586	-	674	719	763	-	845	-	-	-
700021303	ARR 0282	79	L / R	531	604	-	685	741	791	-	883	-	-	-
700021304	ARR 0282	84	L / R	536	611	-	701	756	801	-	898	-	-	-
700021305	ARR 0282	89	L / R	541	618	-	711	758	811	-	905	-	-	-
700021306	ARR 0282	99	L / R	562	643	-	742	793	842	-	937	-	-	-

Wall units
Módulos altos
Modules hauts

Wall unit for extractor
Módulo alto para extractor
Module haut pour hotte

H.96

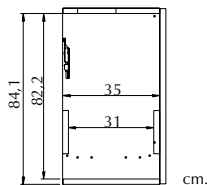
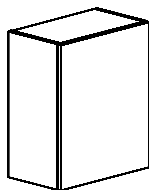

Wall unit for extractor.
1 fixed door.
Available in all models but without handle,
except: See availability.

Módulo alto para extractor.
1 puerta fija.
Disponible en todos los modelos, pero sin
tirador, excepto: Ver disponibilidad.

Module haut pour hotte.
1 porte fixe.
Disponible sur tous les modèles mais
dispens poignée, à l'exception: Voir la
disponibilité

Availability / disponibilidad / disponibilité:

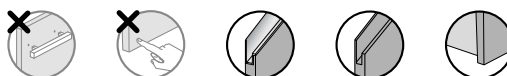

35 depth / profundidad / profondeur

SAP	Code Código Code	Width Ancho Largeur	Opening Apertura Ouverture											
				0	1	2	3	4	5	6	7	8	9	10
700021186	AE 0284	60	-	317	373	-	423	447	475	-	531	-	-	-
700021187	AE 0284	90	-	338	411	-	475	502	531	-	607	-	-	-
700021188	AE 0284	120	-	357	447	-	525	556	600	-	690	-	-	-

61 depth / profundidad / profondeur

SAP	Code Código Code	Width Ancho Largeur	Opening Apertura Ouverture											
				0	1	2	3	4	5	6	7	8	9	10
700021189	AE 0285	60	-	358	413	-	465	495	523	-	574	-	-	-
700021190	AE 0285	90	-	379	450	-	517	545	584	-	649	-	-	-
700021191	AE 0285	120	-	409	498	-	574	607	645	-	745	-	-	-

H.96

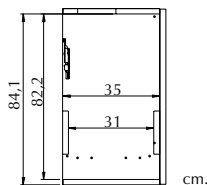
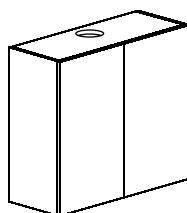

Wall unit for extractor.
2 fixed doors.
Available in all models but without handle,
except: See availability.

Módulo alto para extractor.
2 puertas fijas.
Disponible en todos los modelos, pero sin
tirador, excepto: Ver disponibilidad.

Module haut pour hotte.
2 portes fixes.
Disponible sur tous les modèles mais
dispens poignée, à l'exception: Voir la
disponibilité

Availability / disponibilidad / disponibilité:

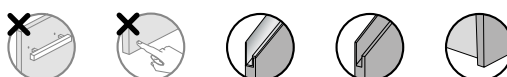

35 depth / profundidad / profondeur

SAP	Code Código Code	Width Ancho Largeur	Opening Apertura Ouverture											
				0	1	2	3	4	5	6	7	8	9	10
700021192	AE 0286	90	-	349	452	-	519	566	615	-	703	-	-	-
700021193	AE 0286	120	-	367	484	-	565	606	661	-	762	-	-	-

61 depth / profundidad / profondeur

SAP	Code Código Code	Width Ancho Largeur	Opening Apertura Ouverture											
				0	1	2	3	4	5	6	7	8	9	10
700021194	AE 0287	90	-	389	491	-	561	608	657	-	746	-	-	-
700021195	AE 0287	120	-	419	536	-	620	667	716	-	825	-	-	-

Wall units
Módulos altos
Modules hauts

Wall unit for extractor
Módulo alto para extractor
Module haut pour hotte

H.96

Wall unit for extractor.
1 door.
1 shelf.
Variable height.

Módulo alto para extractor.
1 puerta.
1 balda.
Altura variable.

Module haut pour hotte.
1 porte.
1 étagère.
Hauteur variable.

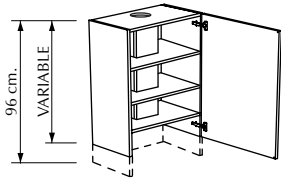

Availability / disponibilidad / disponibilité:

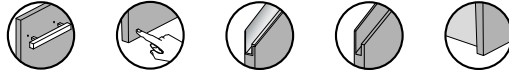

35 depth / profundidad / profondeur

SAP	Code Código Code	Width Ancho Largeur	Opening Apertura Ouverture	0	1	2	3	4	5	6	7	8	9	10
700021202	AE 0290	60	-	615	663	-	734	765	797	-	864	-	-	-

61 depth / profundidad / profondeur

SAP	Code Código Code	Width Ancho Largeur	Opening Apertura Ouverture	0	1	2	3	4	5	6	7	8	9	10
700021205	AE 0291	60	-	674	720	-	795	827	859	-	928	-	-	-

H.96

Wall unit for extractor.
2 doors.
1 shelf.
Variable height.

Módulo alto para extractor.
2 puertas.
1 balda.
Altura variable.

Module haut pour hotte.
2 portes.
1 étagère.
Hauteur variable.

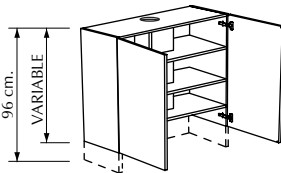

Availability / disponibilidad / disponibilité:

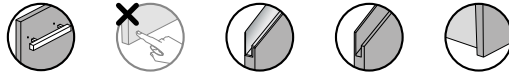

35 depth / profundidad / profondeur

SAP	Code Código Code	Width Ancho Largeur	Opening Apertura Ouverture	0	1	2	3	4	5	6	7	8	9	10
700021203	AE 0290	90	-	666	748	-	851	898	955	-	1060	-	-	-
700021204	AE 0290	120	-	707	802	-	920	977	1035	-	1159	-	-	-

61 depth / profundidad / profondeur

SAP	Code Código Code	Width Ancho Largeur	Opening Apertura Ouverture	0	1	2	3	4	5	6	7	8	9	10
700021206	AE 0291	90	-	734	813	-	921	978	1036	-	1145	-	-	-
700021207	AE 0291	120	-	788	880	-	1006	1063	1122	-	1248	-	-	-

Wall units
Módulos altos
Modules hauts

Wall unit for over-the-range microwave
Módulo alto para horno-microondas-campana.
Module haut pour four micro-ondes hotte

H.96

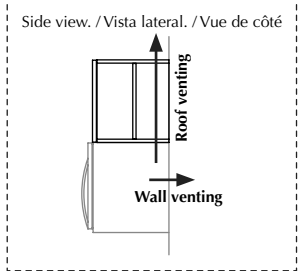
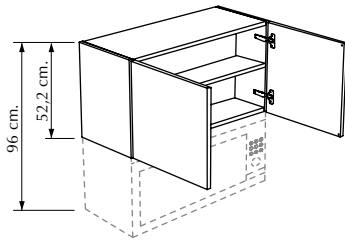

Wall unit for over-the-range microwave.
2 doors.
1 shelf.
1 removable back panel.

Módulo alto para horno-microondas-campana.
2 puertas.
1 balda.
1 trasera desmontable.

Module haut pour four micro-ondes hotte.
2 portes.
1 étagère.
1 panneau arrière démontable.

Availability / disponibilidad / disponibilité:

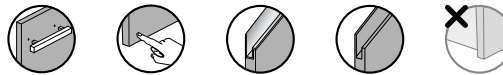

35 depth / profundidad / profondeur

SAP	Code Código Code	Width Ancho Largeur	Opening Apertura Ouverture	0	1	2	3	4	5	6	7	8	9	10
700021275	AE 0321	76,2	-	325	391	-	450	487	528	-	595	-	-	-

H.96

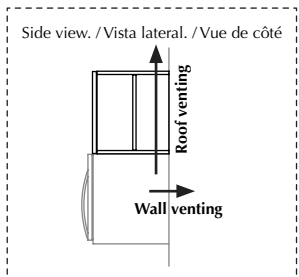
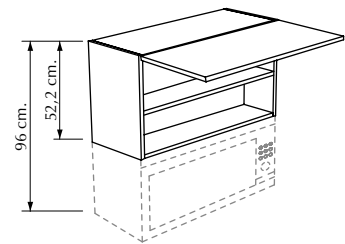

Wall unit for over-the-range microwave.
1 flap door.
1 shelf.
1 removable back panel.

Módulo alto para horno-microondas-campana.
1 puerta abatible.
1 balda.
1 trasera desmontable.

Module haut pour four micro-ondes hotte.
1 porte rabattable.
1 étagère.
1 panneau arrière démontable.

Availability / disponibilidad / disponibilité:

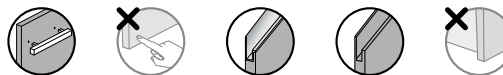

35 depth / profundidad / profondeur

SAP	Code Código Code	Width Ancho Largeur	Opening Apertura Ouverture	0	1	2	3	4	5	6	7	8	9	10
700021271	AE 0317	76,2	-	406	442	-	498	526	556	-	614	-	-	-

Wall units
Módulos altos
Modules hauts

Wall unit for plate draining rack
Módulo alto para escurrer platos
Module haut pour égouttoir

H.96

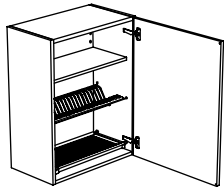

Wall unit for plate draining rack.
1 door.
1 shelf.
1 glass draining tray.
1 plate draining tray.
1 water collecting tray.

Módulo alto para escurrer platos.
1 puerta.
1 balda.
1 bandeja escurre-vasos.
1 bandeja escurre-platos.
1 bandeja recoge-agua.

Module haut pour égouttoir.
1 porte.
1 étagère.
1 plateau égouttoir verres.
1 plateau égouttoir assiettes.
1 plateau dévidoir.

Availability / disponibilidad / disponibilité:

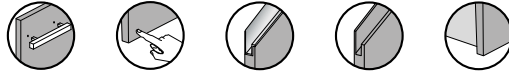

35 depth / profundidad / profondeur

SAP	Code Código Code	Width Ancho Largeur	Opening Apertura Ouverture											
				0	1	2	3	4	5	6	7	8	9	10
700021208	AEQ 0292	45	L / R	398	436	-	493	521	551	-	612	-	-	-
700021209	AEQ 0292	50	L / R	406	447	-	506	533	564	-	619	-	-	-
700021210	AEQ 0292	60	L / R	423	468	-	533	564	592	-	656	-	-	-

61 depth / profundidad / profondeur

SAP	Code Código Code	Width Ancho Largeur	Opening Apertura Ouverture											
				0	1	2	3	4	5	6	7	8	9	10
700021211	AEQ 0293	45	L / R	434	471	-	531	559	589	-	640	-	-	-
700021212	AEQ 0293	50	L / R	443	491	-	545	573	604	-	659	-	-	-
700021213	AEQ 0293	60	L / R	473	525	-	585	617	645	-	710	-	-	-

H.96

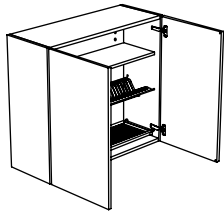

Wall unit for plate draining rack.
2 doors.
1 shelf.
1 glass draining tray.
1 plate draining tray.
1 water collecting tray.

Módulo alto para escurrer platos.
2 puertas.
1 balda.
1 bandeja escurre-vasos.
1 bandeja escurre-platos.
1 bandeja recoge-agua.

Module haut pour égouttoir.
2 portes.
1 étagère.
1 plateau égouttoir verres.
1 plateau égouttoir assiettes.
1 plateau dévidoir.

Availability / disponibilidad / disponibilité:

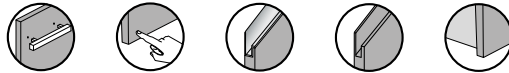

35 depth / profundidad / profondeur









SAP	Code Código Code	Width Ancho Largeur	Opening Apertura Ouverture											
				0	1	2	3	4	5	6	7	8	9	10
700021214	AEQ 0294	80	-	473	564	-	646	689	736	-	833	-	-	-
700021215	AEQ 0294	90	-	496	586	-	673	720	769	-	868	-	-	-

61 depth / profundidad / profondeur

SAP	Code Código Code	Width Ancho Largeur	Opening Apertura Ouverture											
				0	1	2	3	4	5	6	7	8	9	10
700021216	AEQ 0295	80	-	529	613	-	699	748	802	-	894	-	-	-
700021217	AEQ 0295	90	-	548	636	-	728	782	839	-	933	-	-	-

h. 108

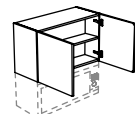
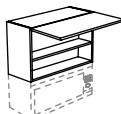
Wall units
Módulos altos
Modules hauts

Type of unit Tipo de módulo Type de module	Available measures Medidas disponibles Dimensions disponibles	Available units Módulos disponibles Modules disponibles
<p>p.230 Wall unit with door Módulo alto con puerta Module haut avec porte</p>	<p>Depth / Profundidad / Profondeur (cm.): 35 - 61</p> <p>Width / Ancho / Largeur (cm.): 30 - 40 - 45 - 50 - 60 - 76,2 - 80 - 90 - 100 - 120</p>	 <p>AP 0323 - 0324</p>  <p>AP 0325 - 0326</p>
<p>p.231 Wall corner unit Módulo alto rinconero Module haut encoignure</p>	<p>Depth / Profundidad / Profondeur (cm.): 35</p> <p>Width / Ancho / Largeur (cm.): 75 - 85 - 90 - 95 - 105</p>	 <p>ARR 0327</p>
<p>p.232 - 234 Wall unit for extractor Módulo alto para extractor Module haut pour hotte</p>	<p>Depth / Profundidad / Profondeur (cm.): 35 - 61</p> <p>Width / Ancho / Largeur (cm.): 60 - 90 - 120</p>	 <p>AE 0328 - 0329</p>  <p>AE 0330 - 0331</p>  <p>AE 0332 - 0333</p>  <p>AE 0332 - 0333</p>  <p>AE 0322</p>  <p>AE 0318</p>
<p>p.235 Wall unit for plate draining rack Módulo alto para escurreplatos Module haut pour égouttoir</p>	<p>Depth / Profundidad / Profondeur (cm.): 35 - 61</p> <p>Width / Ancho / Largeur (cm.): 45 - 50 - 60 - 80 - 90</p>	 <p>AEQ 0334 - 0335</p>  <p>AEQ 0336 - 0337</p>

Wall units
Módulos altos
Modules hauts

Wall unit with door
Módulo alto con puerta
Module haut avec porte

H.108

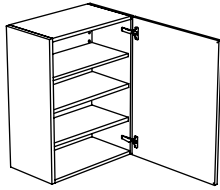

Wall unit with door.
1 door.
3 shelves.

Módulo alto con puerta.
1 puerta.
3 baldas.

Modules haut avec porte.
1 porte.
3 étagères.

Availability / disponibilidad / disponibilité:

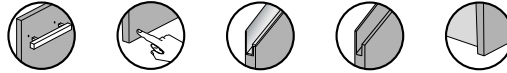

35 depth / profundidad / profondeur

SAP	Code Código Code	Width Ancho Largeur	Opening Apertura Ouverture											
				0	1	2	3	4	5	6	7	8	9	10
700022740	AP 0323	30	L / R	348	384	-	431	457	479	-	527	-	-	-
700022741	AP 0323	40	L / R	368	408	-	462	489	519	-	574	-	-	-
700022742	AP 0323	45	L / R	373	416	-	472	498	530	-	590	-	-	-
700022743	AP 0323	50	L / R	378	430	-	483	508	531	-	592	-	-	-
700022744	AP 0323	60	L / R	392	453	-	511	542	577	-	641	-	-	-

61 depth / profundidad / profondeur

SAP	Code Código Code	Width Ancho Largeur	Opening Apertura Ouverture											
				0	1	2	3	4	5	6	7	8	9	10
700022745	AP 0324	30	L / R	401	434	-	487	517	544	-	595	-	-	-
700022746	AP 0324	40	L / R	420	466	-	517	544	575	-	625	-	-	-
700022747	AP 0324	45	L / R	428	476	-	530	556	583	-	644	-	-	-
700022748	AP 0324	50	L / R	436	486	-	543	568	597	-	662	-	-	-
700022749	AP 0324	60	L / R	469	527	-	591	623	653	-	723	-	-	-

H.108

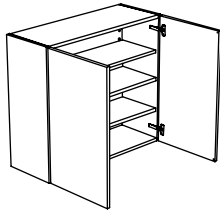

Wall unit with door.
2 doors.
3 shelves.

Módulo alto con puerta.
2 puertas.
3 baldas.

Modules haut avec porte.
2 portes.
3 étagères.

Availability / disponibilidad / disponibilité:

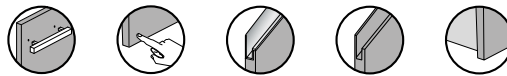

35 depth / profundidad / profondeur

SAP	Code Código Code	Width Ancho Largeur	Opening Apertura Ouverture											
				0	1	2	3	4	5	6	7	8	9	10
700022750	AP 0325	76,2	-	425	516	-	595	645	691	-	784	-	-	-
700022751	AP 0325	80	-	429	530	-	603	648	699	-	789	-	-	-
700022752	AP 0325	90	-	449	556	-	635	678	731	-	831	-	-	-
700022753	AP 0325	100	-	521	632	-	720	767	824	-	928	-	-	-
700022754	AP 0325	120	-	551	677	-	778	835	890	-	1003	-	-	-

61 depth / profundidad / profondeur

SAP	Code Código Code	Width Ancho Largeur	Opening Apertura Ouverture											
				0	1	2	3	4	5	6	7	8	9	10
700022755	AP 0326	76,2	-	509	607	-	684	734	787	-	884	-	-	-
700022756	AP 0326	80	-	516	615	-	694	746	790	-	886	-	-	-
700022757	AP 0326	90	-	535	639	-	724	774	820	-	922	-	-	-
700022758	AP 0326	100	-	612	720	-	815	863	911	-	1024	-	-	-
700022759	AP 0326	120	-	656	780	-	888	946	1009	-	1133	-	-	-

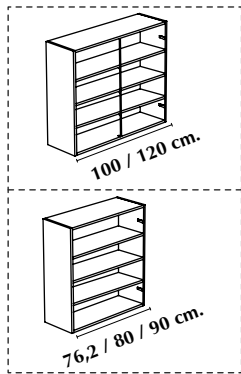

Wall units
Módulos altos
Modules hauts

Wall corner unit
Módulo alto rinconero
Module haut encoignure

H.108

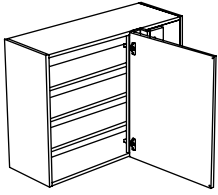

Wall straight corner unit.
1 door.
3 shelves.
1 standard corner filler, 10x10 cm.

Módulo alto rinconero recto.
1 puerta.
3 baldas.
1 regleta de rincón estándar de 10x10 cm.

Module haut encoignure droite.
1 porte.
3 étagères.
1 fileur d'encoignure standard, 10x10 cm.

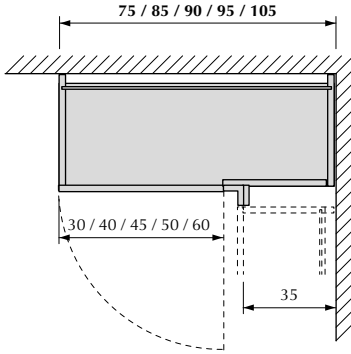

Availability / disponibilidad / disponibilité:

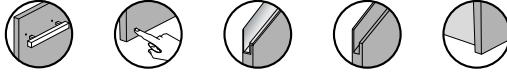

35 depth / profundidad / profondeur

SAP	Code Código Code	Width Ancho Largeur	Opening Apertura Ouverture	0	1	2	3	4	5	6	7	8	9	10
700022760	ARR 0327	75	L / R	537	621	-	692	719	746	-	811	-	-	-
700022761	ARR 0327	85	L / R	547	637	-	700	737	775	-	842	-	-	-
700022762	ARR 0327	90	L / R	563	654	-	734	765	797	-	869	-	-	-
700022763	ARR 0327	95	L / R	568	662	-	731	767	808	-	885	-	-	-
700022764	ARR 0327	105	L / R	586	689	-	764	801	841	-	935	-	-	-

H.108

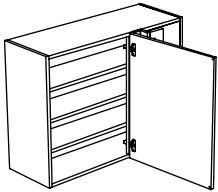

Wall straight corner unit.
1 door.
3 shelves.
1 corner filler with raised door profile, 4x4 cm.

Módulo alto rinconero recto.
1 puerta.
3 baldas.
1 regleta de rincón con perfil de puerta de 4x4 cm.

Module haut encoignure droite.
1 porte.
3 étagères.
1 Fileur d'encoignure avec profilé de porte, 4x4 cm.

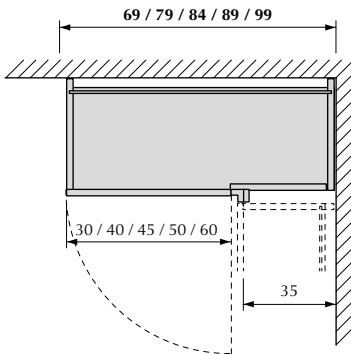

Availability / disponibilidad / disponibilité:

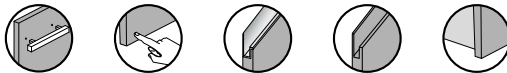

35 depth / profundidad / profondeur

SAP	Code Código Code	Width Ancho Largeur	Opening Apertura Ouverture	0	1	2	3	4	5	6	7	8	9	10
700022791	ARR 0327	69	L / R	532	606	-	693	744	797	-	887	-	-	-
700022792	ARR 0327	79	L / R	542	621	-	714	762	818	-	920	-	-	-
700022793	ARR 0327	84	L / R	548	629	-	725	778	822	-	919	-	-	-
700022794	ARR 0327	89	L / R	556	640	-	739	791	844	-	956	-	-	-
700022795	ARR 0327	99	L / R	574	665	-	764	816	868	-	971	-	-	-

Wall units
Módulos altos
Modules hauts

Wall unit for extractor
Módulo alto para extractor
Module haut pour hotte

H.108

Wall unit for extractor.
1 fixed door.
Available in all models but without handle,
except: See availability.

Módulo alto para extractor.
1 puerta fija.
Disponible en todos los modelos, pero sin
tirador, excepto: Ver disponibilidad.

Module haut pour hotte.
1 porte fixe.
Disponible sur tous les modèles mais
dispens poignée, à l'exception: Voir la
disponibilité

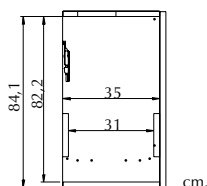
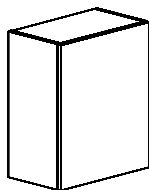

Availability / disponibilidad / disponibilité:

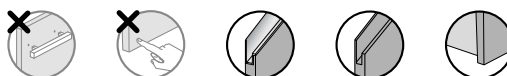

35 depth / profundidad / profondeur

SAP	Code Código Code	Width Ancho Largeur	Opening Apertura Ouverture	0	1	2	3	4	5	6	7	8	9	10
				700022765	AE 0328	60	-	322	377	-	437	462	493	-
700022766	AE 0328	90	-	342	424	-	493	525	557	-	642	-	-	-
700022767	AE 0328	120	-	361	458	-	542	580	619	-	721	-	-	-

61 depth / profundidad / profondeur

SAP	Code Código Code	Width Ancho Largeur	Opening Apertura Ouverture	0	1	2	3	4	5	6	7	8	9	10
				700022768	AE 0329	60	-	371	432	-	489	519	550	-
700022769	AE 0329	90	-	392	472	-	544	577	620	-	694	-	-	-
700022770	AE 0329	120	-	422	518	-	607	641	684	-	785	-	-	-

H.108

Wall unit for extractor.
2 fixed doors.
Available in all models but without handle,
except: See availability.

Módulo alto para extractor.
2 puertas fijas.
Disponible en todos los modelos, pero sin
tirador, excepto: Ver disponibilidad.

Module haut pour hotte.
2 portes fixes.
Disponible sur tous les modèles mais
dispens poignée, à l'exception: Voir la
disponibilité

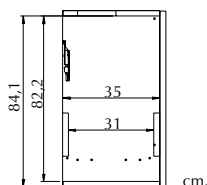
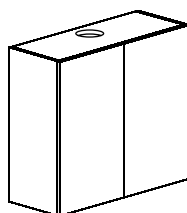

Availability / disponibilidad / disponibilité:

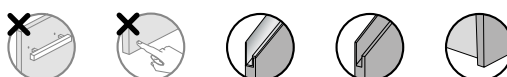

35 depth / profundidad / profondeur

SAP	Code Código Code	Width Ancho Largeur	Opening Apertura Ouverture	0	1	2	3	4	5	6	7	8	9	10
				700022771	AE 0330	90	-	353	462	-	534	577	630	-
700022772	AE 0330	120	-	371	502	-	590	632	702	-	815	-	-	-

61 depth / profundidad / profondeur

SAP	Code Código Code	Width Ancho Largeur	Opening Apertura Ouverture	0	1	2	3	4	5	6	7	8	9	10
				700022773	AE 0331	90	-	402	510	-	585	628	681	-
700022774	AE 0331	120	-	432	562	-	654	709	766	-	879	-	-	-

Wall units
Módulos altos
Modules hauts

Wall unit for extractor
Módulo alto para extractor
Module haut pour hotte

H.108

Wall unit for extractor.
1 door.
1 shelf.
Variable height.

Módulo alto para extractor.
1 puerta.
1 balda.
Altura variable.

Module haut pour hotte.
1 porte.
1 étagère.
Hauteur variable.

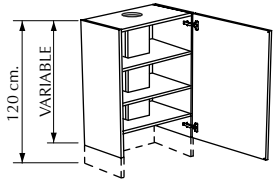

Availability / disponibilidad / disponibilité:

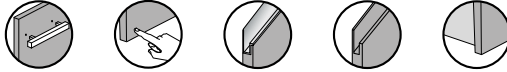

35 depth / profundidad / profondeur

SAP	Code Código Code	Width Ancho Largeur	Opening Apertura Ouverture	0	1	2	3	4	5	6	7	8	9	10
				700022775	AE 0332	60	-	626	680	-	755	791	826	-

61 depth / profundidad / profondeur

SAP	Code Código Code	Width Ancho Largeur	Opening Apertura Ouverture	0	1	2	3	4	5	6	7	8	9	10
				700022778	AE 0333	60	-	693	746	-	826	862	898	-

H.108

Wall unit for extractor.
2 doors.
1 shelf.
Variable height.

Módulo alto para extractor.
2 puertas.
1 balda.
Altura variable.

Module haut pour hotte.
2 portes.
1 étagère.
Hauteur variable.

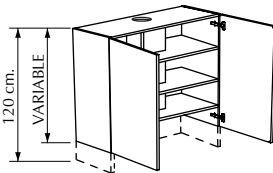

Availability / disponibilidad / disponibilité:

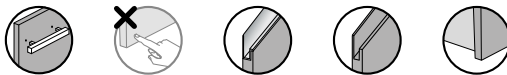

35 depth / profundidad / profondeur

SAP	Code Código Code	Width Ancho Largeur	Opening Apertura Ouverture	0	1	2	3	4	5	6	7	8	9	10
				700022776	AE 0332	90	-	678	779	-	874	930	988	-
700022777	AE 0332	120	-	720	843	-	955	1011	1086	-	1202	-	-	-

61 depth / profundidad / profondeur

SAP	Code Código Code	Width Ancho Largeur	Opening Apertura Ouverture	0	1	2	3	4	5	6	7	8	9	10
				700022779	AE 0333	90	-	754	853	-	954	1002	1050	-
700022780	AE 0333	120	-	811	931	-	1050	1116	1183	-	1323	-	-	-

Wall units
Módulos altos
Modules hauts

Wall unit for over-the-range microwave
Módulo alto para horno-microondas-campana.
Module haut pour four micro-ondes hotte

H.108

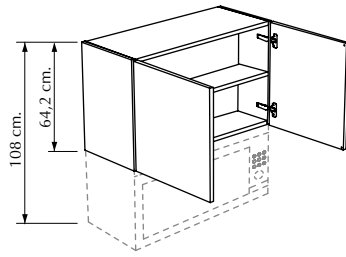

Side view. / Vista lateral. / Vue de côté

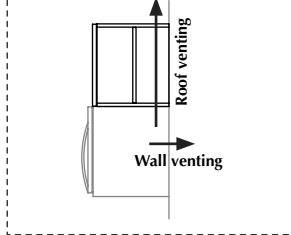

Wall unit for over-the-range microwave.
2 doors.
1 shelf.
1 removable back panel.

Módulo alto para horno-microondas-campana.
2 puertas.
1 balda.
1 trasera desmontable.

Module haut pour four micro-ondes hotte.
2 portes.
1 étagère.
1 panneau arrière démontable.

Availability / disponibilidad / disponibilité:

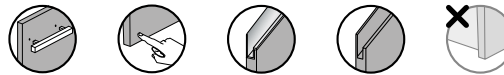

35 depth / profundidad / profondeur

SAP	Code Código Code	Width Ancho Largeur	Opening Apertura Ouverture	35 depth / profundidad / profondeur										
				0	1	2	3	4	5	6	7	8	9	10
700021276	AE 0322	76,2	-	333	403	-	463	509	556	-	622	-	-	-

H.108

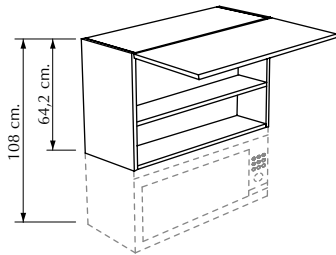

Side view. / Vista lateral. / Vue de côté

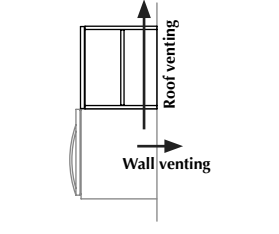

Wall unit for over-the-range microwave.
1 flap door.
1 shelf.
1 removable back panel.

Módulo alto para horno-microondas-campana.
1 puerta abatible.
1 balda.
1 trasera desmontable.

Module haut pour four micro-ondes hotte.
1 porte rabattable.
1 étagère.
1 panneau arrière démontable.

Availability / disponibilidad / disponibilité:

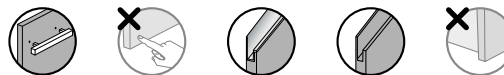

35 depth / profundidad / profondeur

SAP	Code Código Code	Width Ancho Largeur	Opening Apertura Ouverture	35 depth / profundidad / profondeur										
				0	1	2	3	4	5	6	7	8	9	10
700021272	AE 0318	76,2	-	421	461	-	523	552	581	-	649	-	-	-

Wall units
Módulos altos
Modules hauts

Wall unit for plate draining rack
Módulo alto para escurrer platos
Module haut pour égouttoir

H.108

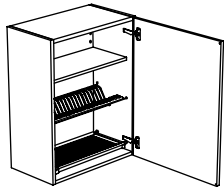

Wall unit for plate draining rack.
1 door.
1 shelf.
1 glass draining tray.
1 plate draining tray.
1 water collecting tray.

Módulo alto para escurrer platos.
1 puerta.
1 balda.
1 bandeja escurre-vasos.
1 bandeja escurre-platos.
1 bandeja recoge-agua.

Module haut pour égouttoir.
1 porte.
1 étagère.
1 plateau égouttoir verres.
1 plateau égouttoir assiettes.
1 plateau dévidoir.

Availability / disponibilidad / disponibilité:

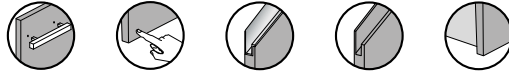

35 depth / profundidad / profondeur

SAP	Code Código Code	Width Ancho Largeur	Opening Apertura Ouverture	0	1	2	3	4	5	6	7	8	9	10
				700022781	AEQ 0334	45	L / R		403	452	-	504	536	563
700022782	AEQ 0334	50	L / R		412	463	-	518	543	572	-	637	-	-
700022783	AEQ 0334	60	L / R		433	492	-	554	585	621	-	691	-	-

61 depth / profundidad / profondeur

SAP	Code Código Code	Width Ancho Largeur	Opening Apertura Ouverture	0	1	2	3	4	5	6	7	8	9	10
				700022784	AEQ 0335	45	L / R	448	496	-	551	578	605	-
700022785	AEQ 0335	50	L / R	458	508	-	567	598	626	-	687	-	-	-
700022786	AEQ 0335	60	L / R	491	549	-	615	647	677	-	748	-	-	-

H.108

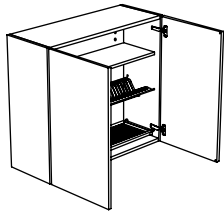

Wall unit for plate draining rack.
2 doors.
1 shelf.
1 glass draining tray.
1 plate draining tray.
1 water collecting tray.

Módulo alto para escurrer platos.
2 puertas.
1 balda.
1 bandeja escurre-vasos.
1 bandeja escurre-platos.
1 bandeja recoge-agua.

Module haut pour égouttoir.
2 portes.
1 étagère.
1 plateau égouttoir verres.
1 plateau égouttoir assiettes.
1 plateau dévidoir.

Availability / disponibilidad / disponibilité:

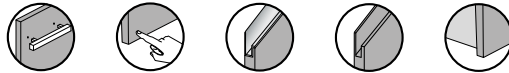

35 depth / profundidad / profondeur









SAP	Code Código Code	Width Ancho Largeur	Opening Apertura Ouverture	0	1	2	3	4	5	6	7	8	9	10
				700022787	AEQ 0336	80	-	480	581	-	657	702	753	-
700022788	AEQ 0336	90	-	506	612	-	694	744	805	-	892	-	-	-

61 depth / profundidad / profondeur

SAP	Code Código Code	Width Ancho Largeur	Opening Apertura Ouverture	0	1	2	3	4	5	6	7	8	9	10
				700022789	AEQ 0337	80	-	545	644	-	725	777	828	-
700022790	AEQ 0337	90	-	567	671	-	758	809	862	-	966	-	-	-

h. 120

Wall units
Módulos altos
Modules hauts

Type of unit Tipo de módulo Type de module	Available measures Medidas disponibles Dimensions disponibles	Available units Módulos disponibles Modules disponibles
<p>p.238 Wall unit with door Módulo alto con puerta Module haut avec porte</p>	<p>Depth / Profundidad / Profondeur (cm.): 35 - 61</p> <p>Width / Ancho / Largeur (cm.): 30 - 40 - 45 - 50 - 60 - 76,2 - 80 - 90 - 100 - 120</p>	 <p>AP 0296 - 0297</p>  <p>AP 0298 - 0299</p>
<p>p.239 Wall corner unit Módulo alto rinconero Module haut encoignure</p>	<p>Depth / Profundidad / Profondeur (cm.): 35</p> <p>Width / Ancho / Largeur (cm.): 75 - 85 - 90 - 95 - 105</p>	 <p>ARR 0300</p>
<p>p.240 - 241 Wall unit for extractor Módulo alto para extractor Module haut pour hotte</p>	<p>Depth / Profundidad / Profondeur (cm.): 35 - 61</p> <p>Width / Ancho / Largeur (cm.): 60 - 90 - 120</p>	 <p>AE 0302 - 0303</p>  <p>AE 0304 - 0305</p>  <p>AE 0308 - 0309</p>  <p>AE 0308 - 0309</p>
<p>p.242 Wall unit for plate draining rack Módulo alto para escurrreplatos Module haut pour égouttoir</p>	<p>Depth / Profundidad / Profondeur (cm.): 35 - 61</p> <p>Width / Ancho / Largeur (cm.): 45 - 50 - 60 - 80 - 90</p>	 <p>AEQ 0310 - 0311</p>  <p>AEQ 0312 - 0313</p>

Wall units
Módulos altos
Modules hauts

Wall unit with door
Módulo alto con puerta
Module haut avec porte

H.120

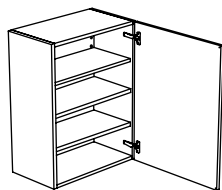

Wall unit with door.
1 door.
3 shelves.

Módulo alto con puerta.
1 puerta.
3 baldas.

Modules haut avec porte.
1 porte.
3 étagères.

Availability / disponibilidad / disponibilité:

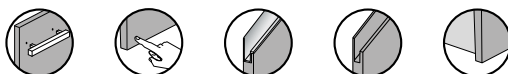

35 depth / profundidad / profondeur

SAP	Code Código Code	Width Ancho Largeur	Opening Apertura Ouverture											
				0	1	2	3	4	5	6	7	8	9	10
700021218	AP 0296	30	L / R	357	401	-	444	471	497	-	543	-	-	-
700021219	AP 0296	40	L / R	373	423	-	473	498	521	-	579	-	-	-
700021220	AP 0296	45	L / R	379	431	-	484	508	532	-	601	-	-	-
700021221	AP 0296	50	L / R	384	439	-	495	523	554	-	618	-	-	-
700021222	AP 0296	60	L / R	398	462	-	524	552	580	-	643	-	-	-

61 depth / profundidad / profondeur

SAP	Code Código Code	Width Ancho Largeur	Opening Apertura Ouverture											
				0	1	2	3	4	5	6	7	8	9	10
700021223	AP 0297	30	L / R	412	455	-	502	526	550	-	598	-	-	-
700021224	AP 0297	40	L / R	428	476	-	530	556	583	-	643	-	-	-
700021225	AP 0297	45	L / R	436	487	-	544	573	603	-	663	-	-	-
700021226	AP 0297	50	L / R	444	498	-	557	586	617	-	683	-	-	-
700021227	AP 0297	60	L / R	477	539	-	607	636	669	-	739	-	-	-

H. 120

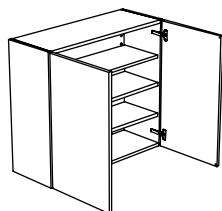

Wall unit with door.
2 doors.
3 shelves.

Módulo alto con puerta.
2 puertas.
3 baldas.

Modules haut avec porte.
2 portes.
3 étagères.

Availability / disponibilidad / disponibilité:

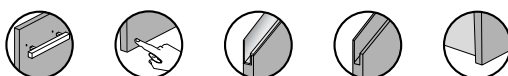

35 depth / profundidad / profondeur

SAP	Code Código Code	Width Ancho Largeur	Opening Apertura Ouverture											
				0	1	2	3	4	5	6	7	8	9	10
700021228	AP 0298	76,2	-	431	536	-	611	658	707	-	802	-	-	-
700021229	AP 0298	80	-	439	546	-	623	665	720	-	811	-	-	-
700021230	AP 0298	90	-	456	569	-	653	698	749	-	844	-	-	-
700021231	AP 0298	100	-	529	645	-	740	790	844	-	959	-	-	-
700021232	AP 0298	120	-	559	693	-	800	852	912	-	1038	-	-	-

61 depth / profundidad / profondeur

SAP	Code Código Code	Width Ancho Largeur	Opening Apertura Ouverture											
				0	1	2	3	4	5	6	7	8	9	10
700021233	AP 0299	76,2	-	519	621	-	702	749	799	-	895	-	-	-
700021234	AP 0299	80	-	528	633	-	717	758	813	-	914	-	-	-
700021235	AP 0299	90	-	544	654	-	745	791	841	-	953	-	-	-
700021236	AP 0299	100	-	621	736	-	837	889	942	-	1058	-	-	-
700021237	AP 0299	120	-	666	798	-	912	966	1025	-	1150	-	-	-

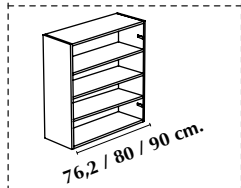
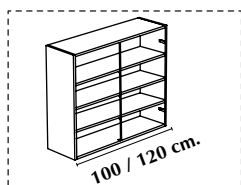

Wall units
Módulos altos
Modules hauts

Wall corner unit
Módulo alto rinconero
Module haut encoignure

H.120

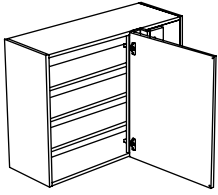

Wall straight corner unit.
1 door.
3 shelves.
1 standard corner filler, 10x10 cm.

Módulo alto rinconero recto.
1 puerta.
3 baldas.
1 regleta de rincón estándar de 10x10 cm.

Module haut encoignure droite.
1 porte.
3 étagères.
1 fileur d'encoignure standard, 10x10 cm.

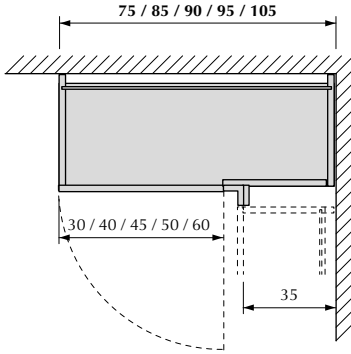

Availability / disponibilidad / disponibilité:

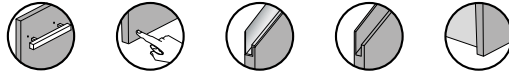

35 depth / profundidad / profondeur

SAP	Code Código Code	Width Ancho Largeur	Opening Apertura Ouverture											
				0	1	2	3	4	5	6	7	8	9	10
700021238	ARR 0300	75	L / R	547	636	-	710	740	772	-	852	-	-	-
700021239	ARR 0300	85	L / R	561	655	-	736	764	799	-	890	-	-	-
700021240	ARR 0300	90	L / R	574	670	-	755	788	818	-	898	-	-	-
700021241	ARR 0300	95	L / R	579	679	-	766	799	829	-	915	-	-	-
700021242	ARR 0300	105	L / R	598	706	-	800	834	872	-	968	-	-	-

H.120

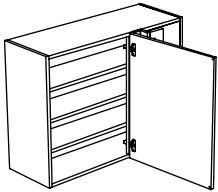

Wall straight corner unit.
1 door.
3 shelves.
1 corner filler with raised door profile, 4x4 cm.

Módulo alto rinconero recto.
1 puerta.
3 baldas.
1 regleta de rincón con perfil de puerta de 4x4 cm.

Module haut encoignure droite.
1 porte.
3 étagères.
1 Fileur d'encoignure avec profilé de porte, 4x4 cm.

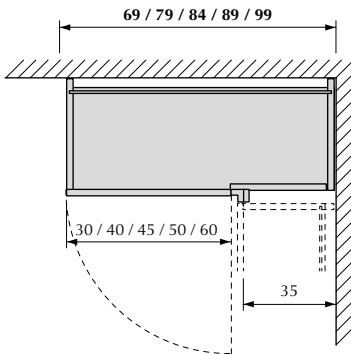

Availability / disponibilidad / disponibilité:

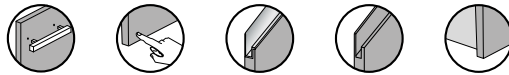

35 depth / profundidad / profondeur

SAP	Code Código Code	Width Ancho Largeur	Opening Apertura Ouverture											
				0	1	2	3	4	5	6	7	8	9	10
700021307	ARR 0300	69	L / R	542	620	-	712	760	816	-	914	-	-	-
700021308	ARR 0300	79	L / R	557	640	-	731	782	835	-	935	-	-	-
700021309	ARR 0300	84	L / R	562	648	-	743	792	839	-	952	-	-	-
700021310	ARR 0300	89	L / R	568	656	-	754	809	866	-	970	-	-	-
700021311	ARR 0300	99	L / R	585	682	-	787	849	908	-	1023	-	-	-

Wall units
Módulos altos
Modules hauts

Wall unit for extractor
Módulo alto para extractor
Module haut pour hotte

H.120

Wall unit for extractor.
1 fixed door.
Available in all models but without handle,
except: See availability.

Módulo alto para extractor.
1 puerta fija.
Disponible en todos los modelos, pero sin
tirador, excepto: Ver disponibilidad.

Module haut pour hotte.
1 porte fixe.
Disponible sur tous les modèles mais
dispens poignée, à l'exception: Voir la
disponibilité

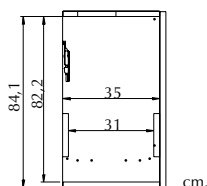
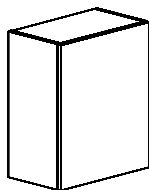

Availability / disponibilidad / disponibilité:

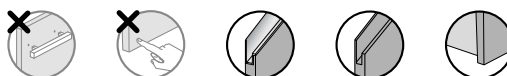

35 depth / profundidad / profondeur

SAP	Code Código Code	Width Ancho Largeur	Opening Apertura Ouverture											
				0	1	2	3	4	5	6	7	8	9	10
700021243	AE 0302	60	-	326	392	-	448	475	505	-	568	-	-	-
700021244	AE 0302	90	-	347	433	-	507	535	572	-	667	-	-	-
700021245	AE 0302	120	-	365	469	-	560	587	625	-	751	-	-	-

61 depth / profundidad / profondeur

SAP	Code Código Code	Width Ancho Largeur	Opening Apertura Ouverture											
				0	1	2	3	4	5	6	7	8	9	10
700021246	AE 0303	60	-	378	442	-	503	531	564	-	633	-	-	-
700021247	AE 0303	90	-	398	484	-	561	596	638	-	720	-	-	-
700021248	AE 0303	120	-	429	532	-	627	656	705	-	818	-	-	-

H.120

Wall unit for extractor.
2 fixed doors.
Available in all models but without handle,
except: See availability.

Módulo alto para extractor.
2 puertas fijas.
Disponible en todos los modelos, pero sin
tirador, excepto: Ver disponibilidad.

Module haut pour hotte.
2 portes fixes.
Disponible sur tous les modèles mais
dispens poignée, à l'exception: Voir la
disponibilité

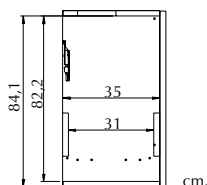
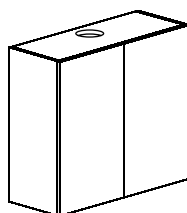

Availability / disponibilidad / disponibilité:

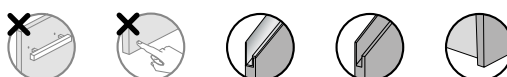

35 depth / profundidad / profondeur

SAP	Code Código Code	Width Ancho Largeur	Opening Apertura Ouverture											
				0	1	2	3	4	5	6	7	8	9	10
700021249	AE 0304	90	-	357	472	-	549	599	645	-	740	-	-	-
700021250	AE 0304	120	-	375	514	-	608	656	720	-	846	-	-	-

61 depth / profundidad / profondeur

SAP	Code Código Code	Width Ancho Largeur	Opening Apertura Ouverture											
				0	1	2	3	4	5	6	7	8	9	10
700021251	AE 0305	90	-	408	522	-	603	653	699	-	794	-	-	-
700021252	AE 0305	120	-	439	576	-	675	724	787	-	913	-	-	-

Wall units
Módulos altos
Modules hauts

Wall unit for extractor
Módulo alto para extractor
Module haut pour hotte

H.120

Wall unit for extractor.
1 door.
1 shelf.
Variable height.

Módulo alto para extractor.
1 puerta.
1 balda.
Altura variable.

Module haut pour hotte.
1 porte.
1 étagère.
Hauteur variable.

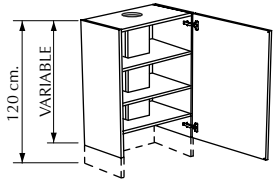

Availability / disponibilidad / disponibilité:

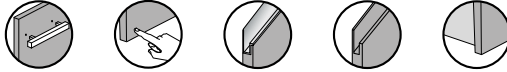

35 depth / profundidad / profondeur

SAP	Code Código Code	Width Ancho Largeur	Opening Apertura Ouverture	0	1	2	3	4	5	6	7	8	9	10
				700021253	AE 0308	60	-	637	695	-	774	809	845	-

61 depth / profundidad / profondeur

SAP	Code Código Code	Width Ancho Largeur	Opening Apertura Ouverture	0	1	2	3	4	5	6	7	8	9	10
				700021256	AE 0309	60	-	706	763	-	847	883	919	-

H.120

Wall unit for extractor.
2 doors.
1 shelf.
Variable height.

Módulo alto para extractor.
2 puertas.
1 balda.
Altura variable.

Module haut pour hotte.
2 portes.
1 étagère.
Hauteur variable.

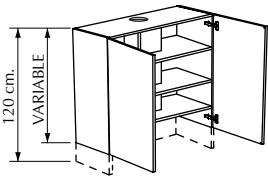

Availability / disponibilidad / disponibilité:

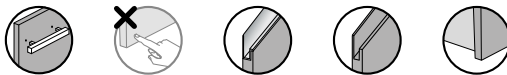

35 depth / profundidad / profondeur

SAP	Code Código Code	Width Ancho Largeur	Opening Apertura Ouverture	0	1	2	3	4	5	6	7	8	9	10
				700021254	AE 0308	90	-	693	800	-	900	957	1015	-
700021255	AE 0308	120	-	733	863	-	983	1039	1115	-	1244	-	-	-

61 depth / profundidad / profondeur

SAP	Code Código Code	Width Ancho Largeur	Opening Apertura Ouverture	0	1	2	3	4	5	6	7	8	9	10
				700021257	AE 0309	90	-	772	877	-	983	1041	1100	-
700021258	AE 0309	120	-	826	954	-	1080	1147	1214	-	1343	-	-	-

Wall units
Módulos altos
Modules hauts

Wall unit for plate draining rack
Módulo alto para escurreplatos
Module haut pour égouttoir

H.120

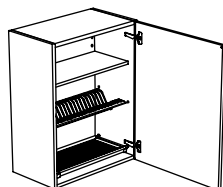

Wall unit for plate draining rack.
1 door.
1 shelf.
1 glass draining tray.
1 plate draining tray.
1 water collecting tray.

Módulo alto para escurreplatos.
1 puerta.
1 balda.
1 bandeja escurre-vasos.
1 bandeja escurre-platos.
1 bandeja recoge-agua.

Module haut pour égouttoir.
1 porte.
1 étagère.
1 plateau égouttoir verres.
1 plateau égouttoir assiettes.
1 plateau dévidoir.

Availability / disponibilidad / disponibilité:

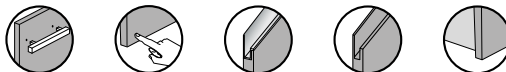

35 depth / profundidad / profondeur

SAP	Code Código Code	Width Ancho Largeur	Opening Apertura Ouverture											
				0	1	2	3	4	5	6	7	8	9	10
700021259	AEQ 0310	45	L / R	409	461	-	516	540	569	-	634	-	-	-
700021260	AEQ 0310	50	L / R	418	472	-	530	558	584	-	643	-	-	-
700021261	AEQ 0310	60	L / R	439	502	-	567	596	629	-	699	-	-	-

61 depth / profundidad / profondeur

SAP	Code Código Code	Width Ancho Largeur	Opening Apertura Ouverture											
				0	1	2	3	4	5	6	7	8	9	10
700021262	AEQ 0311	45	L / R	456	507	-	565	595	625	-	686	-	-	-
700021263	AEQ 0311	50	L / R	466	520	-	581	610	641	-	708	-	-	-
700021264	AEQ 0311	60	L / R	500	562	-	631	661	693	-	764	-	-	-

H.120

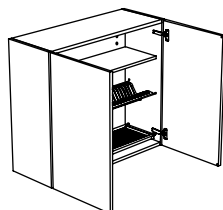

Wall unit for plate draining rack.
2 doors.
1 shelf.
1 glass draining tray.
1 plate draining tray.
1 water collecting tray.

Módulo alto para escurreplatos.
2 puertas.
1 balda.
1 bandeja escurre-vasos.
1 bandeja escurre-platos.
1 bandeja recoge-agua.

Module haut pour égouttoir.
2 portes.
1 étagère.
1 plateau égouttoir verres.
1 plateau égouttoir assiettes.
1 plateau dévidoir.

Availability / disponibilidad / disponibilité:

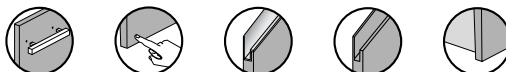

35 depth / profundidad / profondeur

SAP	Code Código Code	Width Ancho Largeur	Opening Apertura Ouverture											
				0	1	2	3	4	5	6	7	8	9	10
700021265	AEQ 0312	80	-	490	596	-	677	725	781	-	873	-	-	-
700021266	AEQ 0312	90	-	513	624	-	712	765	816	-	920	-	-	-

61 depth / profundidad / profondeur

SAP	Code Código Code	Width Ancho Largeur	Opening Apertura Ouverture											
				0	1	2	3	4	5	6	7	8	9	10
700021267	AEQ 0313	80	-	557	661	-	747	796	852	-	945	-	-	-
700021268	AEQ 0313	90	-	577	686	-	779	833	892	-	1007	-	-	-

Complements for wall unit
Complementos para módulo alto
Compléments pour module haut

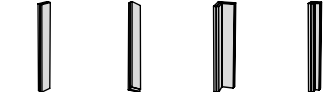
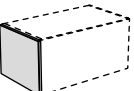
Type of unit Tipo de módulo Type de module	Available measures Medidas disponibles Dimensions disponibles	Available units Módulos disponibles Modules disponibles
<p>p.246 - 247 Fillers Regletas Fileursne</p>	<p>Height / Altura / Hauteur (cm.): 36 - 38 - 42 - 44 - 60 - 62 - 72 - 74 - 84 - 86 - 96 - 98 - 108 - 110 - 120 - 122</p>	 <p>BRE 0850 BRE 0851 BRE 0854 BRE 0855</p>
<p>p.248 Decorative side panels Paneles decorativos Panneaux décoratifs</p>	<p>Depth / Profundidad / Profondeur (cm.): 35 - 61</p> <p>Height / Altura / Hauteur (cm.): 36 - 38 - 42 - 44 - 60 - 62 - 72 - 74 - 84 - 86 - 96 - 98 - 108 - 110 - 120 - 122</p>	 <p>APD 0857 - 0859</p>

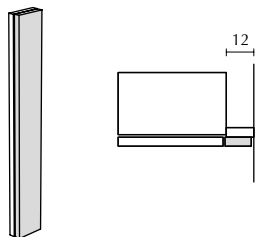

Front filler piece.
Plain design.
Width, 12 cm.

Regleta de ajuste.
Diseño liso.
Ancho, 12 cm.

Fileur d'ajustement.
Modèle lisse.
Largeur, 12 cm.

12 width / ancho / largeur

SAP	Code Código Code	Height Altura Hauteur	Position Posición Position											
				0	1	2	3	4	5	6	7	8	9	10
700022082	ARE 0850	36	-	-	68	-	75	-	81	-	-	-	-	-
700022084	ARE 0850	48	-	-	71	-	79	-	86	-	-	-	-	-
700022085	ARE 0850	60	-	-	74	-	83	-	91	-	-	-	-	-
700022086	ARE 0850	72	-	-	76	-	86	-	95	-	-	-	-	-
700022088	ARE 0850	84	-	-	80	-	91	-	100	-	-	-	-	-
700022089	ARE 0850	96	-	-	82	-	94	-	104	-	-	-	-	-
700022796	ARE 0850	108	-	-	85	-	97	-	109	-	-	-	-	-
700022090	ARE 0850	120	-	-	87	-	100	-	113	-	-	-	-	-

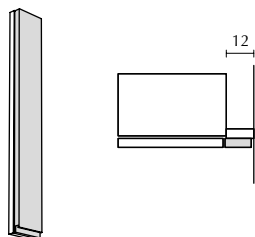

Front filler piece with raised door profile.
Plain design.
Width, 12 cm.

Regleta de ajuste con perfil de puerta.
Diseño liso.
Ancho, 12 cm.

Fileur d'ajustement avec profilé de porte.
Modèle lisse.
Largeur, 12 cm.

Availability / disponibilidad / disponibilité:

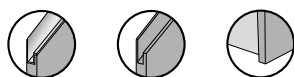

12 width / ancho / largeur

SAP	Code Código Code	Height Altura Hauteur	Position Posición Position											
				0	1	2	3	4	5	6	7	8	9	10
700022100	ARE 0851	36	-	-	-	-	-	122	130	-	132	-	-	-
700022101	ARE 0851	38	-	-	-	-	-	123	131	-	133	-	-	-
700022103	ARE 0851	48	-	-	-	-	-	125	134	-	137	-	-	-
700022104	ARE 0851	50	-	-	-	-	-	126	135	-	138	-	-	-
700022105	ARE 0851	60	-	-	-	-	-	128	138	-	142	-	-	-
700022106	ARE 0851	62	-	-	-	-	-	129	139	-	143	-	-	-
700022107	ARE 0851	72	-	-	-	-	-	131	142	-	147	-	-	-
700022108	ARE 0851	74	-	-	-	-	-	132	143	-	148	-	-	-
700022110	ARE 0851	84	-	-	-	-	-	135	147	-	153	-	-	-
700022111	ARE 0851	86	-	-	-	-	-	136	148	-	154	-	-	-
700022112	ARE 0851	96	-	-	-	-	-	139	154	-	161	-	-	-
700022113	ARE 0851	98	-	-	-	-	-	140	155	-	162	-	-	-
700022797	ARE 0851	108	-	-	-	-	-	142	158	-	166	-	-	-
700022809	ARE 0851	110	-	-	-	-	-	143	159	-	167	-	-	-
700022114	ARE 0851	120	-	-	-	-	-	145	161	-	170	-	-	-
700022115	ARE 0851	122	-	-	-	-	-	152	162	-	173	-	-	-

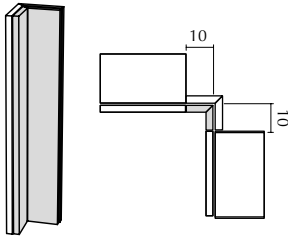

Corner filler piece for 90° solution.
Plain design.
Distance between units, 10x10 cm.

Regleta de rincón, ángulo 90°.
Diseño liso.
Distancia entre módulos, 10x10 cm.

Fileur d'encoignure, angle 90°.
Modèle lisse.
Distance entre modules, 10x10 cm.

10 width / ancho / largeur

SAP	Code Código Code	Height Altura Hauteur	Position Posición Position											
				0	1	2	3	4	5	6	7	8	9	10
700022120	ARE 0854	36	-	-	102	-	115	-	125	-	-	-	-	-
700022121	ARE 0854	38	-	-	103	-	117	-	127	-	-	-	-	-
700022123	ARE 0854	48	-	-	107	-	123	-	136	-	-	-	-	-
700022124	ARE 0854	50	-	-	108	-	124	-	137	-	-	-	-	-
700022125	ARE 0854	60	-	-	113	-	130	-	146	-	-	-	-	-
700022126	ARE 0854	62	-	-	114	-	131	-	148	-	-	-	-	-
700022127	ARE 0854	72	-	-	118	-	138	-	157	-	-	-	-	-
700022128	ARE 0854	74	-	-	119	-	139	-	158	-	-	-	-	-
700022130	ARE 0854	84	-	-	124	-	145	-	167	-	-	-	-	-
700022131	ARE 0854	86	-	-	125	-	146	-	169	-	-	-	-	-
700022132	ARE 0854	96	-	-	129	-	152	-	177	-	-	-	-	-
700022133	ARE 0854	98	-	-	130	-	153	-	179	-	-	-	-	-
700022798	ARE 0854	108	-	-	134	-	159	-	188	-	-	-	-	-
700022810	ARE 0854	110	-	-	135	-	160	-	189	-	-	-	-	-
700022134	ARE 0854	120	-	-	139	-	166	-	198	-	-	-	-	-
700022135	ARE 0854	122	-	-	140	-	167	-	199	-	-	-	-	-

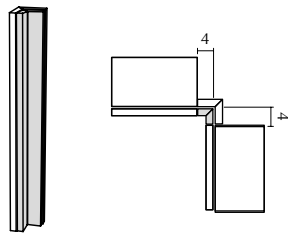

Corner filler piece for 90° solution.
Plain design.
Distance between units, 4x4 cm.

Regleta de rincón, ángulo 90°.
Diseño liso.
Distancia entre módulos, 4x4 cm.

Fileur d'encoignure, angle 90°.
Modèle lisse.
Distance entre modules, 4x4 cm.

4 width / ancho / largeur

SAP	Code Código Code	Height Altura Hauteur	Position Posición Position											
				0	1	2	3	4	5	6	7	8	9	10
700022145	ARE 0855	36	-	-	98	-	111	149	154	-	163	-	-	-
700022146	ARE 0855	38	-	-	99	-	112	-	122	-	-	-	-	-
700022148	ARE 0855	48	-	-	103	-	119	156	161	-	174	-	-	-
700022149	ARE 0855	50	-	-	104	-	120	-	133	-	-	-	-	-
700022150	ARE 0855	60	-	-	109	-	126	162	169	-	185	-	-	-
700022151	ARE 0855	62	-	-	110	-	127	-	144	-	-	-	-	-
700022152	ARE 0855	72	-	-	114	-	133	168	176	-	195	-	-	-
700022153	ARE 0855	74	-	-	115	-	135	-	154	-	-	-	-	-
700022155	ARE 0855	84	-	-	120	-	141	174	184	-	206	-	-	-
700022156	ARE 0855	86	-	-	121	-	142	-	165	-	-	-	-	-
700022157	ARE 0855	96	-	-	125	-	148	180	192	-	217	-	-	-
700022158	ARE 0855	98	-	-	126	-	149	-	175	-	-	-	-	-
700022799	ARE 0855	108	-	-	132	-	157	190	203	-	231	-	-	-
700022811	ARE 0855	110	-	-	133	-	158	-	187	-	-	-	-	-
700022159	ARE 0855	120	-	-	139	-	166	200	214	-	245	-	-	-
700022160	ARE 0855	122	-	-	140	-	167	-	199	-	-	-	-	-

Wall units
Módulos altos
Modules hauts

Decorative side panels
Paneles decorativos
Panneaux décoratifs

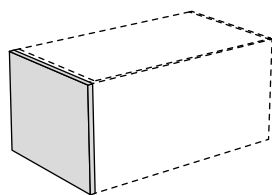

Decorative side panel.
Panel thickness, 19 mm.
On level with front.

Panel decorativo.
Espesor de panel, 19 mm.
A ras de frente.

Panneau décoratif.
Épaisseur du panneau, 19 mm.
Au ras de façade.

61 depth / profundidad / profondeur

SAP	Height Altura Hauteur	R1		R2		R3	
700022173	36	APDL 0857	39	APDR 0857	54	APDE 0857	72
700022174	38	APDL 0857	39	APDR 0857	56	APDE 0857	74
700022176	48	APDL 0857	45	APDR 0857	65	APDE 0857	88
700022177	50	APDL 0857	46	APDR 0857	66	APDE 0857	90
700022178	60	APDL 0857	49	APDR 0857	72	APDE 0857	102
700022179	62	APDL 0857	50	APDR 0857	74	APDE 0857	104
700022180	72	APDL 0857	53	APDR 0857	80	APDE 0857	116
700022181	74	APDL 0857	54	APDR 0857	81	APDE 0857	118
700022183	84	APDL 0857	57	APDR 0857	88	APDE 0857	130
700022184	86	APDL 0857	58	APDR 0857	89	APDE 0857	132
700022185	96	APDL 0857	63	APDR 0857	98	APDE 0857	146
700022186	98	APDL 0857	63	APDR 0857	99	APDE 0857	148
700022800	108	APDL 0857	67	APDR 0857	106	APDE 0857	160
700022812	110	APDL 0857	67	APDR 0857	107	APDE 0857	162
700022187	120	APDL 0857	71	APDR 0857	113	APDE 0857	174
700022188	122	APDL 0857	71	APDR 0857	115	APDE 0857	176

35 depth / profundidad / profondeur

SAP	Height Altura Hauteur	R1		R2		R3	
700022223	36	APDL 0859	34	APDR 0859	44	APDE 0859	54
700022224	38	APDL 0859	34	APDR 0859	45	APDE 0859	55
700022226	48	APDL 0859	36	APDR 0859	49	APDE 0859	62
700022227	50	APDL 0859	36	APDR 0859	50	APDE 0859	64
700022228	60	APDL 0859	38	APDR 0859	54	APDE 0859	71
700022229	62	APDL 0859	39	APDR 0859	55	APDE 0859	72
700022230	72	APDL 0859	41	APDR 0859	58	APDE 0859	79
700022231	74	APDL 0859	41	APDR 0859	59	APDE 0859	81
700022233	84	APDL 0859	46	APDR 0859	66	APDE 0859	90
700022234	86	APDL 0859	46	APDR 0859	67	APDE 0859	92
700022235	96	APDL 0859	48	APDR 0859	71	APDE 0859	99
700022236	98	APDL 0859	49	APDR 0859	72	APDE 0859	100
700022802	108	APDL 0859	51	APDR 0859	76	APDE 0859	107
700022814	110	APDL 0859	52	APDR 0859	77	APDE 0859	109
700022237	120	APDL 0859	53	APDR 0859	80	APDE 0859	115
700022238	122	APDL 0859	54	APDR 0859	81	APDE 0859	117

06

equipment for base, wall and tower units
equipamiento para módulos bajos, altos y columnas
équipement pour modules bas, hauts et colonnes

- p.252** Open shelving aluminium profile
Estantería abierta perfil aluminio
Étagère ouverte profil aluminium
- p.256** Organizers for drawers
Organizadores para cajones
Aménagement pour tiroirs
- p.258** Waste disposal bins for units with door
Cubos de residuos para módulos con puerta
Poubelles pour modules avec porte
- p.259** Accessories
Accesorios
Accessoires
- p.260** Lighting rod
Barra de iluminación
Barre LED
- p.262** LED lighting on aluminium profile
Iluminación LED sobre perfil de aluminio
Éclairage LED sur le profil en aluminium
- p.264** Independent electrical components
Componentes eléctricos independientes
Composants électriques indépendants

Open shelving made with aluminium profile (2x2 cm).
Profile finish Negro Sable.
Shelves available in all Residence finishes.
Price per measure range.
The number of shelves is determined by the selected height range.
Is required to attach drawing with the profile height and depth, the shelves width and shelves' height position.

Estantería abierta con perfil de aluminio (2x2 cm).
Acabado de perfil Negro Sable.
Estantes disponibles en todos los acabados Residence.
Precio por rango de medida.
El número de baldas viene determinado por el rango de altura seleccionado.
Se requiere adjuntar plano indicando la altura y la profundidad del perfil, la anchura de las baldas y la posición en altura de las baldas.

Étagère ouverte avec profilé en aluminium (2x2 cm).
Finition de profilé, Negro Sable.
Étagères disponibles dans toutes les finitions de Residence.
Prix par gamme de mesure.
Le nombre d'étagères est déterminé par la gamme de hauteur sélectionnée.
Il est nécessaire d'attacher le dessin avec la hauteur et la profondeur du profil, la largeur des étagères et la position en hauteur des étagères.

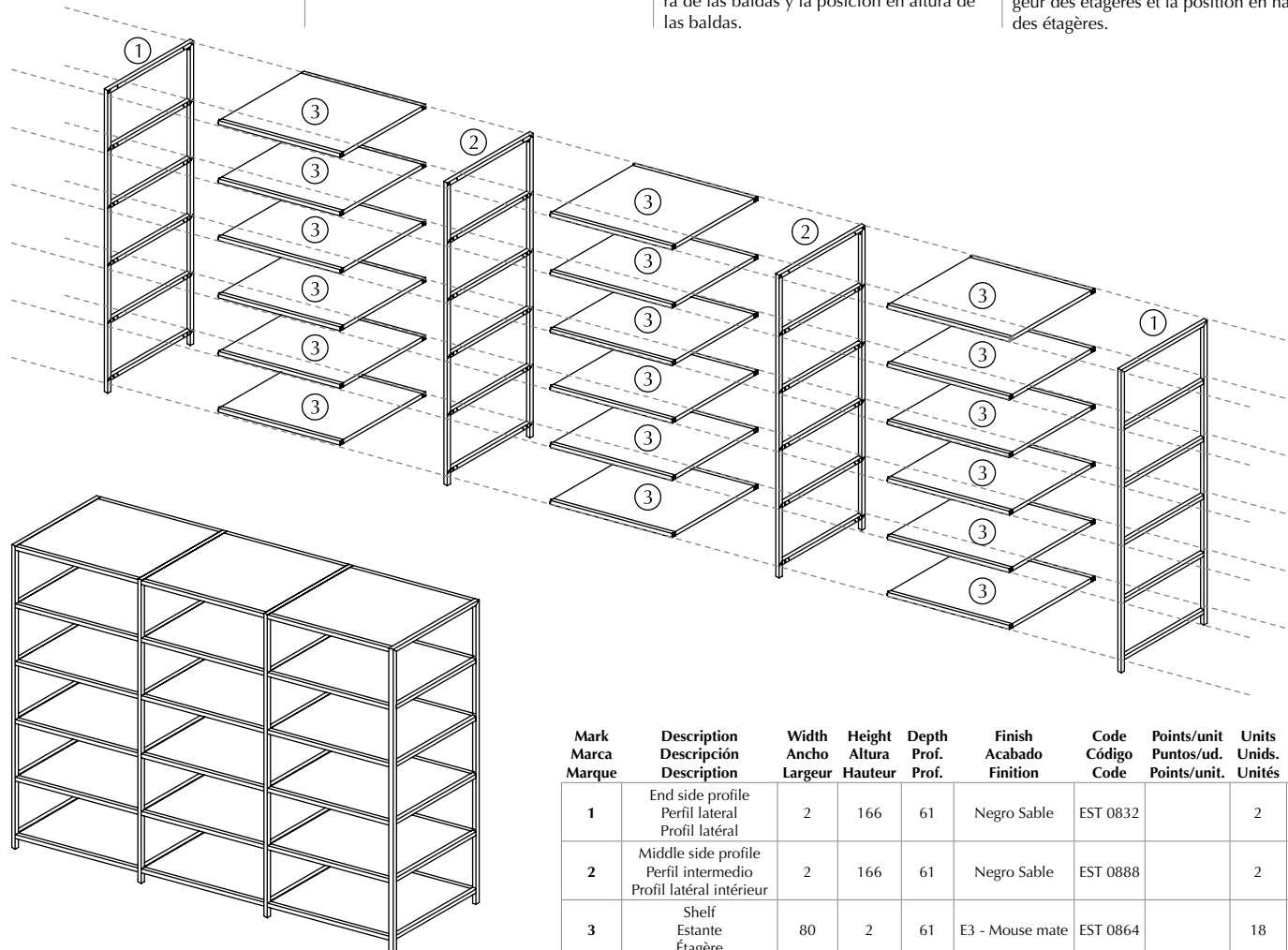

Mark Marca Marque	Description Descripción Description	Width Ancho Largeur	Height Altura Hauteur	Depth Prof. Prof.	Finish Acabado Finition	Code Código Code	Points/unit Puntos/ud. Points/unit.	Units Unids. Unités	Points Puntos
1	End side profile Perfil lateral Profil latéral	2	166	61	Negro Sable	EST 0832		2	
2	Middle side profile Perfil intermedio Profil latéral intérieur	2	166	61	Negro Sable	EST 0888		2	
3	Shelf Estante Étagère	80	2	61	E3 - Mouse mate	EST 0864		18	
TOTAL		248	166	61	TOTAL				

Always order shelf or unit to place on profile top.

Solicitar siempre balda o módulo para la parte superior del perfil.

Toujours commander étagère ou module pour placer sur le haut du profil.

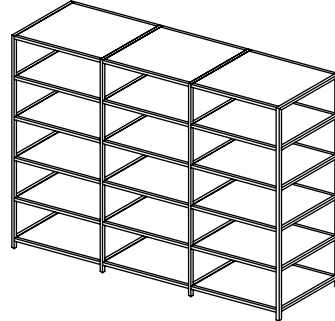
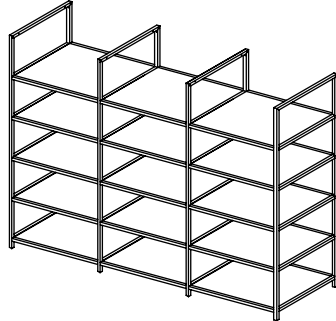

It is recommended to fix the shelf laterally.

Se recomienda anclar siempre la estantería lateralmente.

Il est recommandé de fixer l'étagère latéralement.

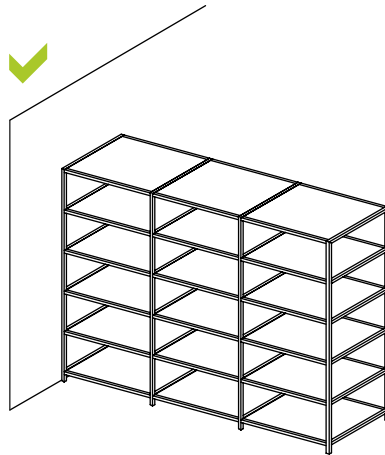
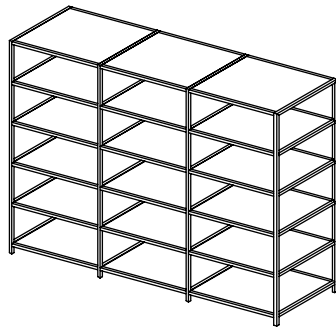

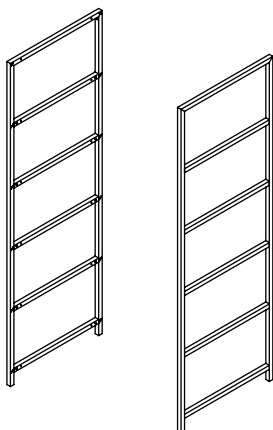

End side profile.
End side supports for shelves are included.
Maximum number of shelves per height:
<95: 4 shelves.
95 < 160: 6 shelves.
160 < 220: 8 shelves.
220 < 280: 10 shelves.

Perfil lateral.
Incluye soportes laterales para las baldas.
Número máximo de baldas por altura:
<95: 4 baldas.
95 < 160: 6 baldas.
160 < 220: 8 baldas.
220 < 280: 10 baldas.

Profil latéral.
Supports latéraux pour les étagères sont inclus.
Nombre maximum d'étagères par hauteur:
<95: 4 baldas.
95 < 160: 6 étagères.
160 < 220: 8 étagères.
220 < 280: 10 étagères.

62,5 < 72,5 depth / profundidad / profondeur

SAP	Code Código Code	Height Altura Hauteur	Points Puntos Points
700022644	XEQU 0948	< 95	494
700022646	XEQU 0950	95 < 160	675
700022648	XEQU 0952	160 < 220	885
700022650	XEQU 0954	220 < 280	1143

52,5 < 62,5 depth / profundidad / profondeur

SAP	Code Código Code	Height Altura Hauteur	Points Puntos Points
700022636	XEQU 0940	< 95	487
700022638	XEQU 0942	95 < 160	666
700022640	XEQU 0944	160 < 220	872
700022642	XEQU 0946	220 < 280	1128

38 < 52,5 depth / profundidad / profondeur

SAP	Code Código Code	Height Altura Hauteur	Points Puntos Points
700022628	XEQU 0932	< 95	481
700022630	XEQU 0934	95 < 160	657
700022632	XEQU 0936	160 < 220	860
700022634	XEQU 0938	220 < 280	1112

< 38 depth / profundidad / profondeur

SAP	Code Código Code	Height Altura Hauteur	Points Puntos Points
700022620	XEQU 0924	< 95	472
700022622	XEQU 0926	95 < 160	643
700022624	XEQU 0928	160 < 220	842
700022626	XEQU 0930	220 < 280	1090

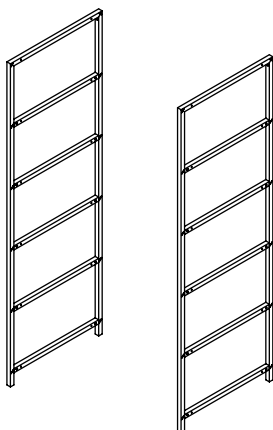

Middle side profile.
End side supports for shelves are included.
Maximum number of shelves per height:
<95: 4 shelves.
95 < 160: 6 shelves.
160 < 220: 8 shelves.
220 < 280: 10 shelves.

Perfil intermedio.
Incluye soportes laterales para las baldas.
Número máximo de baldas por altura:
<95: 4 baldas.
95 < 160: 6 baldas.
160 < 220: 8 baldas.
220 < 280: 10 baldas.

Profil latéral intérieur.
Supports latéraux pour les étagères sont inclus.
Nombre maximum d'étagères par hauteur:
<95: 4 baldas.
95 < 160: 6 étagères.
160 < 220: 8 étagères.
220 < 280: 10 étagères.

62,5 < 72,5 depth / profundidad / profondeur

SAP	Code Código Code	Height Altura Hauteur	Points Puntos Points
700022645	XEQU 0949	< 95	542
700022647	XEQU 0951	95 < 160	751
700022649	XEQU 0953	160 < 220	982
700022651	XEQU 0955	220 < 280	1257

52,5 < 62,5 depth / profundidad / profondeur

SAP	Code Código Code	Height Altura Hauteur	Points Puntos Points
700022637	XEQU 0941	< 95	536
700022639	XEQU 0943	95 < 160	742
700022641	XEQU 0945	160 < 220	969
700022643	XEQU 0947	220 < 280	1242

38 < 52,5 depth / profundidad / profondeur

SAP	Code Código Code	Height Altura Hauteur	Points Puntos Points
700022629	XEQU 0933	< 95	530
700022631	XEQU 0935	95 < 160	732
700022633	XEQU 0937	160 < 220	957
700022635	XEQU 0939	220 < 280	1226

< 38 depth / profundidad / profondeur

SAP	Code Código Code	Height Altura Hauteur	Points Puntos Points
700022621	XEQU 0925	< 95	521
700022623	XEQU 0927	95 < 160	719
700022625	XEQU 0929	160 < 220	939
700022627	XEQU 0931	220 < 280	1203

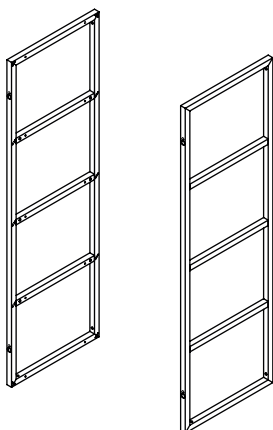

Wall hung end side profile.
End side supports for shelves are included.
Maximum number of shelves per height:
<62: 3 shelves.
62 < 92: 4 shelves.
92 < 122,2: 5 shelves.

Perfil lateral suspendido.
Incluye soportes laterales para las baldas.
Número máximo de baldas por altura:
<62: 3 baldas.
62 < 92: 4 baldas.
92 < 122,2: 5 baldas.

Profil latéral au mur.
Supports latéraux pour les étagères sont inclus.
Nombre maximum d'étagères par hauteur:
<62: 3 baldas.
62 < 92: 4 étagères.
92 < 122,2: 5 étagères.

< 38 depth / profundidad / profondeur

SAP	Code Código Code	Height Altura Hauteur	Points Puntos Points
700022715	XEQU 0980	< 62	352
700022717	XEQU 0982	62 < 92	434
700022719	XEQU 0984	92 < 122,2	511

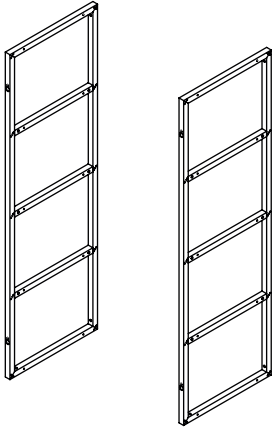

Wall hung middle side profile.
End side supports for shelves are included.
Maximum number of shelves per height:
<62: 3 shelves.
62 < 92: 4 shelves.
92 < 122,2: 5 shelves.

Perfil intermedio suspendido.
Incluye soportes laterales para las baldas.
Número máximo de baldas por altura:
<62: 3 baldas.
62 < 92: 4 baldas.
92 < 122,2: 5 baldas.

Profil latéral intérieur au mur.
Supports latéraux pour les étagères sont inclus.
Nombre maximum d'étagères par hauteur:
<62: 3 baldas.
62 < 92: 4 étagères.
92 < 122,2: 5 étagères.

< 38 depth / profundidad / profondeur			
SAP	Code Código Code	Height Altura Hauteur	Points Puntos Points
700022716	XEQU 0981	< 62	384
700022718	XEQU 0983	62 < 92	476
700022720	XEQU 0985	92 < 122,2	563

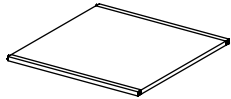

Shelf.
End side supports for shelves are included.

Balda.
Incluye soportes laterales para las baldas.

Étagère.
Supports latéraux pour les étagères sont inclus.

62,5 < 72,5 depth / profundidad / profondeur							
SAP	Width Ancho Largeur	R1		R2		R3	
		700022664	< 30,2	BALL 0968	65	BALR 0968	84
700022665	30,2 < 60,2	BALL 0969	79	BALR 0969	108	BALE 0969	139
700022666	60,2 < 90,2	BALL 0970	93	BALR 0970	133	BALE 0970	180
700022667	90,2 < 120,2	BALL 0971	103	BALR 0971	153	BALE 0971	217

52,5 < 62,5 depth / profundidad / profondeur							
SAP	Width Ancho Largeur	R1		R2		R3	
		700022660	< 30,2	BALL 0964	63	BALR 0964	81
700022661	30,2 < 60,2	BALL 0965	76	BALR 0965	102	BALE 0965	128
700022662	60,2 < 90,2	BALL 0966	85	BALR 0966	120	BALE 0966	160
700022663	90,2 < 120,2	BALL 0967	97	BALR 0967	142	BALE 0967	196

38 < 52,5 depth / profundidad / profondeur							
SAP	Width Ancho Largeur	R1		R2		R3	
		700022656	< 30,2	BALL 0960	62	BALR 0960	77
700022657	30,2 < 60,2	BALL 0961	69	BALR 0961	92	BALE 0961	113
700022658	60,2 < 90,2	BALL 0962	80	BALR 0962	111	BALE 0962	143
700022659	90,2 < 120,2	BALL 0963	88	BALR 0963	126	BALE 0963	170

< 38 depth / profundidad / profondeur							
SAP	Width Ancho Largeur	R1		R2		R3	
		700022652	< 30,2	BALL 0956	59	BALR 0956	73
700022653	30,2 < 60,2	BALL 0957	65	BALR 0957	83	BALE 0957	97
700022654	60,2 < 90,2	BALL 0958	74	BALR 0958	98	BALE 0958	120
700022655	90,2 < 120,2	BALL 0959	80	BALR 0959	109	BALE 0959	139

Drawer organizer for cutlery.
A knife-rack, a paper-holder or a wooden cutting block can be added.
The code includes the complete organizer composition except for the knife-rack, paper holder and the cutting block, that must be ordered separately.

Organizador de cajón para cubiertos.
Pueden incorporar un cuchillero, un porta-rollos y/o una tabla de corte de madera.
El código incluye toda la composición del organizador excepto el cuchillero, port-rollos y la tabla de corte, que se piden por separado.

Range couverts.
Ils peuvent incorporer un porte-rouleau, range-couteaux et/ou planche à découper en bois.
Le code inclus toute la composition du range-couverts excepté le porte-rouleau, le range-couteaux et le planche à découper, qu'il faut commander séparément.



Organizers distribution / Distribución de organizadores / Distribution des aménagements

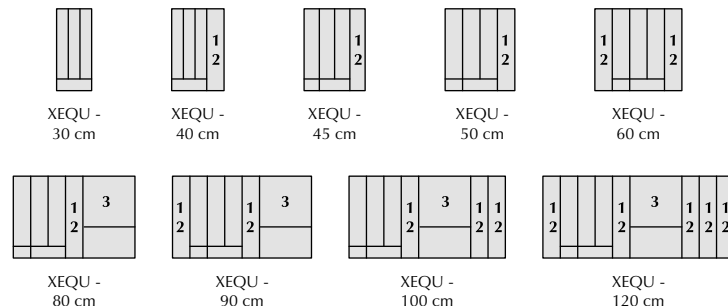

Optional items / Artículos opcionales / Articles optionnels

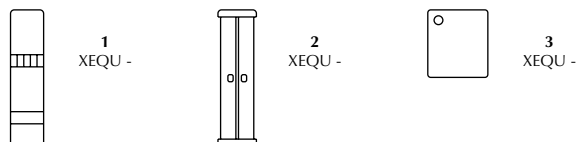

1 - knife-rack / cuchillero / range-couteaux.
2 - paper holder / porta-rollos / porte-rouleau
3 - cutting block / tabla de corte / planche à découper

SAP	Code Código Code	Unit width Ancho módulo Largeur module	Points Puntos Points
250043790	XEQU 0992	30	11
250043791	XEQU 0992	40	12
250043764	XEQU 0992	45	14
250043792	XEQU 0992	50	15
250043783	XEQU 0992	60	17
250043772	XEQU 0992	80	31
250043784	XEQU 0992	90	34
250043768	XEQU 0992	100	86
250043776	XEQU 0992	120	104
250043767	XEQU 0993	-	56
250043765	XEQU 0994	-	69
250043785	XEQU 0995	-	36

Drawer organizer for cutlery.
Wooden finish.
A knife-rack, a paper-holder or a spice rack holder can be added.
The code includes the complete organizer composition except for the knife-rack, paper holder and the cutting block, that must be ordered separately.

Organizador de cajón para cubiertos.
Acabado en madera.
Pueden incorporar un cuchillero, un porta-rollos y/o un especiero.
El código incluye toda la composición del organizador excepto el cuchillero, port-rollos y la tabla de corte, que se piden por separado.

Range couverts.
Finition en bois.
Ils peuvent incorporer un porte-rouleau, range-couteaux et/ou aménagement pour àpices.
Le code inclut toute la composition du range-couverts excepté le porte-rouleau, le range-couteaux et le planche à découper, qu'il faut commander séparément.



Organizers distribution / Distribución de organizadores / Distribution des aménagements

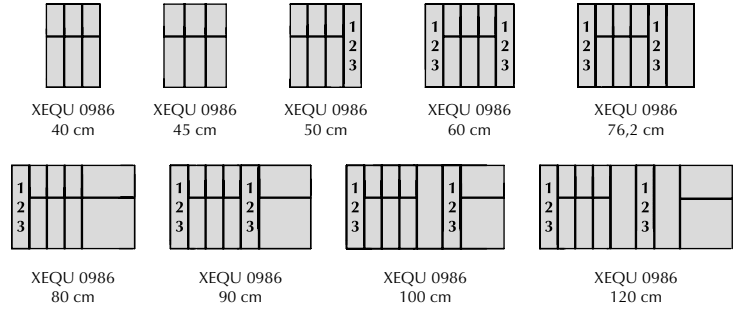

Optional items / Artículos opcionales / Articles optionnels

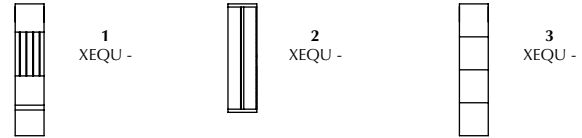

SAP	Code Código Code	Unit width Ancho módulo Largeur module	Points Puntos Points
100209859	XEQU 0986	40	75
100209880	XEQU 0986	45	79
100209881	XEQU 0986	50	96
100209882	XEQU 0986	60	117
100209883	XEQU 0986	76,2	145
100209884	XEQU 0986	80	134
100209885	XEQU 0986	90	155
100209886	XEQU 0986	100	161
100209887	XEQU 0986	120	202
100209888	XEQU 0987	-	77
100209889	XEQU 0988	-	107
100209890	XEQU 0989	-	54

1 - knife-rack / cuchillero / range-couteaux.
2 - paper holder / porta-rollos / porte-rouleau
3 - Spice rack holder / especiero / aménagement pour àpices



Baskets for deep drawer made of wood.
Two sizes:
24,5x17x46 cm (width x height x depth).
24,5x17x23 cm (width x height x depth).

Cestas para gavetas fabricadas en madera.
Dos medidas:
24,5x17x46 cm (ancho x alto x profundo).
24,5x17x23 cm (ancho x alto x profundo).

Paniers pour extractibles fabriqués en bois.
Deux tailles:
24,5x17x46 cm (largeur x hauteur x prof.).
24,5x17x23 cm (largeur x hauteur x prof.).

Examples / Ejemplos / Exemples:

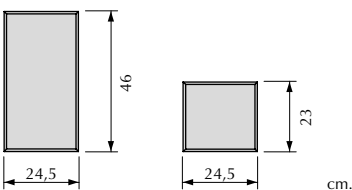
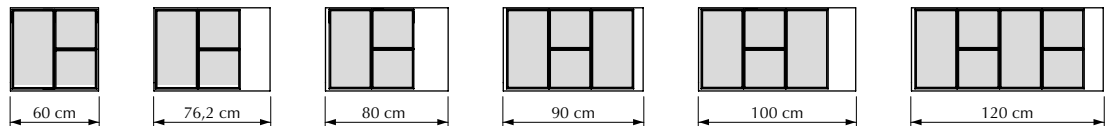

SAP	Code Código Code	Depth Profundidad Profondeur	Points Puntos Points
100209891	XEQU 0990	46	160
100209892	XEQU 0991	23	124

Equipment
 Equipamiento
 Équipement

Waste disposal bins for units with door
 Cubos de residuos para módulos con puerta
 Poubelles pour modules avec porte

Waste disposal bins for units with drawer.
 Bins height, 277 mm.

Cubos de residuos para módulos con cajón
 Altura de cubos, 277 mm.

Poubelles pour modules avec tiroir.
 Hauteur de poubelles, 277 mm.



SAP	Code Código Code	Unit width Ancho módulo Largeur module	Points Puntos Points
700022668	XEQU 0972	60	132
700022669	XEQU 0972	90	171
700022670	XEQU 0972	120	250

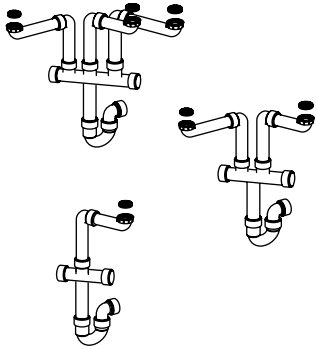

Flat trap.
Specials pipes for dishwasher and washing machine.

Sifón plano.
Con tomas especiales para lavavajillas y lavadora.

Siphon plat.
Prises spéciales pour lave-vaisselle et machine à laver.

	SAP	Code Código Code	Points Puntos Points
1-inlet trap / Sifón de 1 vía / Siphon 1 voie	250011791	XEQU 1024	25
2-inlet trap / Sifón de 2 vías / Siphon 2 voies	250011792	XEQU 1025	38
3-inlet trap / Sifón de 3 vías / Siphon 3 voies	250011794	XEQU 1026	52



When planning a section of LED lighting rod, the following points must be observed:

- Corners can not be designed.
- Ask always for lighting at the same time that ask for decorative panel to make the machining.
- Maximum LED lighting rod length: Decorative panel length - 10 cm.

Cuando se modula un tramo de iluminación con barras LED, se deben respetar los siguientes puntos:

- No se pueden proyectar esquinas.
- Pedir siempre junto con el material de revestimiento para el mecanizado interior.
- La medida total de las barras LED deberá ser como máximo 10 cm menor que el material de revestimiento.

Respectez les points suivants lors de la conception d'une section de Barre LED:

- Les coins peuvent pas être projetées.
- Demandez toujours la barre de LED avec le matériau de revêtement pour l'usinage intérieur.
- Maximum longueur de barre LED: longueur du panneau décoratif - 10 cm.

Example / Ejemplo / Exemple

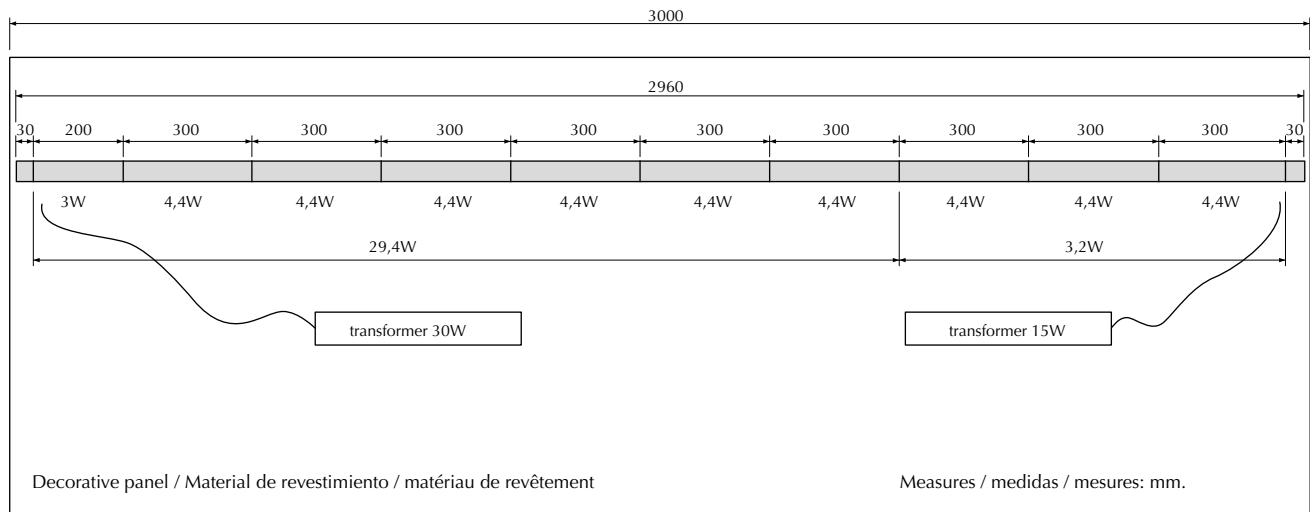

Planit	Unitis Unidades Unités	Composition elements	Elementos de la composición	Éléments de la composition
	1	Decorative panel.	Material de revestimiento.	Matériau de revêtement.
	9	30 cm, 4,4 W LED lighting rod.	Barra de LED de 30 cm, 4,4 W.	Barre LED de 30 cm, 4,4 W.
	1	20 cm, 3 W LED lighting rod.	Barra de LED de 20 cm, 3 W.	Barre LED de 20 cm, 3 W.
	1	540 cm length, decorative profile.	Perfil embellecedor de 54 cm.	Décoratif profile de 54 cm.
	1	15 W LED transformer.s	Transformador LED de 15 W.	Transformateur LED de 15 W.
	1	30 W LED transformer.	Transformador LED de 30 W.	Transformateur LED de 30 W.
	2	Electric lead.	Cable de alimentación.	Câble d'alimentation.

LED lighting rod.
30,000 hours of life.
Note:
-It requires transformer (XILU 1020 / 1022 / 1023).
-The LED lighting rod requires decorative profile (XILU 0998/099).

Barra de iluminación LED.
30.000 horas de duración.
Nota:
-Requiere transformador (XILU 1020 / 1022 / 1023).
-Es necesario cubrir las barras mediante el perfil embellecedor (XILU 0998/099).

Barre LED.
30.000 heures de vie.
Remarque:
-Il nécessite transformateur (XILU 1020 / 1022 / 1023).
-Bars doit être couvert par le profil décoratif (XILU 0998/099).



SAP	Code Código Code	Length Longitud Longueur	Points Puntos Points
250034218	XILU 0996	20 cm (3 W)	91
250034219	XILU 0997	30 cm (4,4 W)	116

Decorative profile for LED lighting rod.
Only to be installed in decorative panels and shelves from 19 mm thickness.

Perfil embellecedor para barra de iluminación LED.
Únicamente para instalar en material de revestimiento y estantes a partir de 19 mm. de espesor.

Profil décoratif pour barre LED.
Seul pour installation sur matériau de revêtement et étagères à partir de 19 mm d'épaisseur.



SAP	Code Código Code	Length Longitud Longueur	Points Puntos Points
100094660	XILU 0998	2,7 m.	81
100094661	XILU 0999	5,4 m.	146

Electric lead.
To connect the transformer and first LED lighting rod.
Lead length, 250 cm.
Note:
-It is necessary to ask for the same amount of electric leads than the transformers.

Cable de alimentación.
Para conexión entre el transformador y la primera barra LED.
Longitud de cable, 250 cm.
Nota:
-Es necesario pedir la misma cantidad de cables que de transformadores.

Câble d'alimentation.
Pour la connexion entre le transformateur et le premier barre LED.
Longueur du câble, 250 cm.
Remarque:
-Il est nécessaire demandez la même quantité de câbles et de transformateurs.



SAP	Code Código Code	Points Puntos Points
250034223	XILU 1000	13

Equipment
Equipamiento
Équipement

LED lighting on aluminium profile
Iluminación LED sobre perfil de aluminio
Éclairage LED sur le profil en aluminium



Aluminium corner profile.
19 x 19 mm (height x depth).
Length, 1 or 2,95 m.

Perfil de esquina en aluminio.
19 x 19 mm (alto x profundo).
Longitud, 1 o 2,95 m.

Profil d'angle en aluminium.
19 x 19 mm (hauteur x profondeur).
Longeur, 1 ou 2,95 m.

SAP	Code Código Code	Length Longitud Longueur	Points Puntos Points
250044673	XILU 1001	2,95 m.	76
250043500	XILU 1002	1 m.	32

Side cover set.
Set of 2 with screws

Set de tapas laterales.
2 tapas con tornillos.

Set de couvercles latéraux.
2 couvercles avec des vis.



SAP	Code Código Code	Points Puntos Points
250043512	XILU 1003	13



LED cover profile.
It has to cover the entire length of the
aluminum profile.

Tira cubre Led.
Debe cubrir toda la longitud el perfil de
aluminio.

Bande pour couvrir l'éclairage LED.
Il doit couvrir la longueur du profilé en
aluminium.

SAP	Code Código Code	Length Longitud Longueur	Points Puntos Points
100193335	XILU 1004	2 m.	52
100193338	XILU 1005	4 m.	97
100193341	XILU 1006	6 m.	142



LED tape.
Light temperature, 4.000° K.
It requires transformer (XILU 1020 / 1022 / 1023).
Installation should be double-sided adhesive tape.
Supply cable not included.

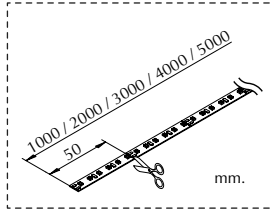

Tira iluminación LED.
Temperatura de luz, 4.000° K.
Requiere transformador (XILU 1020 / 1022 / 1023).
Se debe colocar con cinta adhesiva de doble cara.
Cable de alimentación no incluido.

Bande LED.
Température Lumière, 4.000° K.
Il nécessite transformateur (XILU 1020 / 1022 / 1023).
L'installation doit être réalisée avec un ruban adhésif double face.
Câble d'alimentation non inclus.

SAP	Code Código Code	Length Longitud Longueur	Points Puntos Points
100193308	XILU 1007	1 m.	138
100193320	XILU 1008	2 m.	269
100193313	XILU 1009	3 m.	401
100193316	XILU 1010	4 m.	532
100193319	XILU 1011	5 m.	664

Supply cable.
Cable length, 2,5 m.

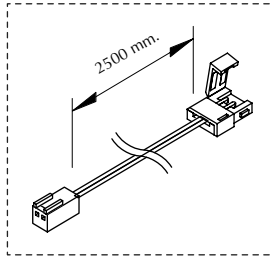

Cable de alimentación.
Longitud del cable, 2,5 m.

Câble d'alimentation.
Longueur de câble, 2,5 m.

SAP	Code Código Code	Points Puntos Points
250043480	XILU 1012	11

Connecting cable LED Tape.
For corner connection.

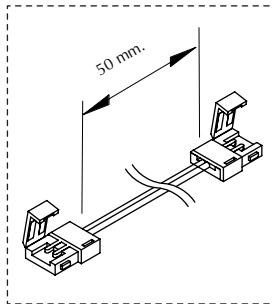
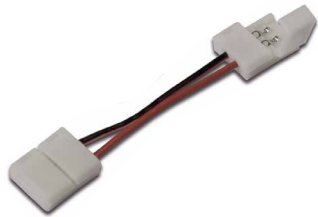

Cable de conexión entre tiras LED.
Para conexión en ángulo.

Câble de connexion entre bandes LED.
Pour la connexion en angle.

SAP	Code Código Code	Points Puntos Points
250043490	XILU 1013	7

Connecting clip LED Tape.
For straight connection.



Clip de conexión entre tiras LED.
Para conexión recta.

Clip de connexion entre bande LED.
Pour la connexion droite.

SAP	Code Código Code	Points Puntos Points
250043491	XILU 1014	4



Retractable socket.
In order to hide the sockets in the worktop.
2 sockets and USB charger.
Installation for surface thickness of up to 40 mm.
Overall installation height: 53 mm.
Overall measures: 226 x 106 mm.
Fixed supply lead 2,5 m.

Enchufe sobreencimera.
Para ocultar los enchufes en la encimera.
2 enchufes y cargador USB.
Instalación sobre superficies de hasta 40 mm de espesor.
Altura de la instalación: 53 mm.
Dimensiones totales: 226 x 106 mm.
Se suministra con 2,5 m de cable.

Prise de courant.
Pour dissimuler les prises de courants, sur les plans de travail.
Matériel: châssis en aluminium
2 prises de courants et chargeur USB.
Installation sur des surfaces jusqu'à 40 mm d'épaisseur.
Hauteur d'installation: 53 mm.
Dimensions totales: 226 x 106 mm.
Livré avec de 2,5 m de câble.

SAP	Code Código Code	Available for: Disponible para: Disponible pour:	Points Puntos Points
100161803	XILU 1015	EUROPE	479

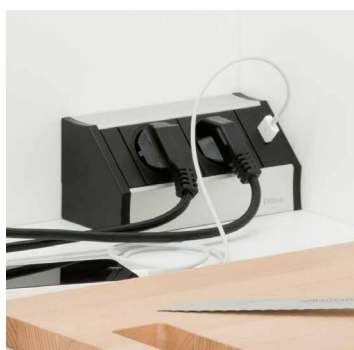

Socket element for interior of shutter door units
Metallic and black colours.
Length, 155 mm.
2 sockets and USB charger.

Elemento con base de enchufes, para interior de módulos.
Color metálico y negro.
Longitud, 155 mm.
2 enchufes y cargador USB.

Élément avec prises électriques pour intérieur de modules persienne
Couleurs métallique et noir.
Longueur, 155 mm.
2 prises de courants et chargeur USB.

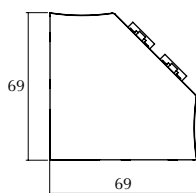

SAP	Code Código Code	Available for: Disponible para: Disponible pour:	Points Puntos Points
100161813	XILU 1016	EUROPE	216
100161802	XILU 1017	UK	216



4 W LED lamp / 4.000° K.
For 68 mm opening.
250 cm bridge wiring included.
Transformer required (XILU 1020 / 1022 / 1023).

Foco de iluminación LED de 4 W / 4.000°K
Para hueco de 68 mm.
Acabado en color acero.
Incluye cable de conexión de 250cm.
Transformador necesario (XILU 1020 / 1022 / 1023).

Projecteur éclairage LED de 4 W / 4.000°K.
Pour ouverture de 68 mm.
Finition en couleur acier.
Comprend câble de 250 cm.
Transformateur nécessaire (XILU 1020 / 1022 / 1023).

SAP	Code Código Code	Points Puntos Points
250042871	XILU 1018	99



4 W LED lamp / 4.000° K.
For 68 mm opening.
250 cm bridge wiring included.
Transformer required (XILU 1020 / 1022 / 1023).

Foco de iluminación LED de 4 W / 4.000°K
Para hueco de 68 mm.
Acabado en color acero.
Incluye cable de conexión de 250cm.
Transformador necesario (XILU 1020 / 1022 / 1023).

Projecteur éclairage LED de 4 W / 4.000°K.
Pour ouverture de 68 mm.
Finition en couleur acier.
Comprend câble de 250 cm.
Transformateur nécessaire (XILU 1020 / 1022 / 1023).

SAP	Code Código Code	Points Puntos Points
250042872	XILU 1019	99

15 W electronic transformer for LED lighting.
Max. connection, 3 lamps x 4W.
Max. connection, 100 cm rod length.
Lead length: 200 cm.
N/A USA.

Transformador electrónico de 15 W para foco LED.
Conexión máxima, 3 focos x 4W.
Conexión máxima, 100 cm de barra.
Longitud del cable, 200 cm.
N/A USA.

Transformateur électronique de 15 W pour éclairage LED.
Connexion max. 3 projecteurs x 4W.
Connexion max., 100 cm barre.
Longueur du câble, 200 cm.
N/A USA.

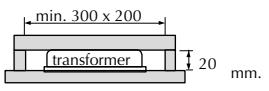

SAP	Code Código Code	Power Potencia Puissance	Available for: Disponible para: Disponible pour:	Points Puntos Points
250034230	XILU 1020	15W	EUROPE	61

30 W electronic transformer.
Max. connection, 7 lamps x 4W.
Maximum connection, 200 cm rod length
Lead length: 200 cm.
Note:
-This transformer doesn't fit in the gap between wall unit and wall.
-It is necessary to ask for the same amount of electric leads than the transformers.

Transformador electrónico de 30 W.
Conexión máxima, 7 focos x 4W.
Conexión máxima, 200 cm de barra.
Longitud del cable, 200 cm.
Nota:
-Este transformador no cabe en el hueco de las traseras de los módulos altos.
-Es necesario pedir la misma cantidad de cables que de transformadores.

Transformateur électronique de 30 W.
Connexion max. 7 projecteurs x 4W.
Connexion maximale, 200 cm barre
Longueur du câble, 200 cm.
Remarque:
-Ce transformateur ne rentre pas dans l'écart entre les module haut et mur.
-Il est nécessaire demandez la même quantité de câbles et de transformat.

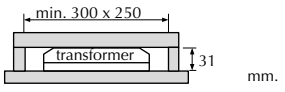

SAP	Code Código Code	Points Puntos Points	
N/A USA	250034225	XILU 1022	109
For USA	250036550	XILU 1023	206

07

plinths
zócalos
plinthes

p.268 Flat plinth
Zócalo liso
Plinthe lisse

plinths
zócalos
plinthes

Flat plinth
Zócalo liso
Plinthe lisse

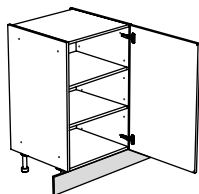

Flat plinth front.
Made of aluminium.
Steel finish.
With insulating profile on the bottom edge.
Whole strips 410 cm.
Price per item.

Frente de zócalo liso.
Fabricado en aluminio.
Acabado en acero.
Con perfil aislante en el canto inferior.
Tiras enteras de 410 cm.
Precio por unidad.

Façade de plinthe lisse.
Fabriqué en aluminium.
Finition en acier.
Avec profilé isolant sur chant inférieur.
Bande complète 410 cm.
Prix par unité.

SAP	Height Altura Hauteur	Steel finish Acabado acero Finition acier	
250043677	10	ZOCA 1027	166
250043668	12	ZOCA 1028	174

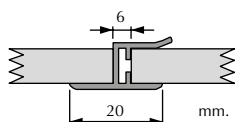

Straight joint piece bottom edge.
Made of aluminium.

Pieza de unión recta.
Fabricado en aluminio.

Pièce d'assemblage droit.
Fabriqué en aluminium.

SAP	Height Altura Hauteur	Steel finish Acabado acero Finition acier	
250043679	10	ZOCA 1029	4
250043691	12	ZOCA 1030	6

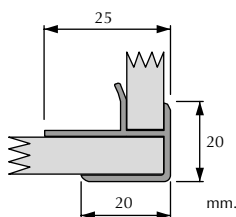

Corner piece for union at 90°.
Made of aluminium.

Cantonera para unión a 90°.
Fabricado en aluminio.

Cornière pour l'union à 90°.
Fabriqué en aluminium.

SAP	Height Altura Hauteur	Steel finish Acabado acero Finition acier	
250043649	10	ZOCA 1031	5
250043658	12	ZOCA 1032	5

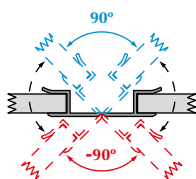

Corner piece for variable angle union.
Made of aluminium.

Cantonera para unión en ángulo variable.
Fabricado en aluminio.

Cornière pour l'union à angle variable.
Fabriqué en aluminium.

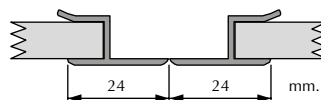

SAP	Height Altura Hauteur	Steel finish Acabado acero Finition acier	
250043681	10	ZOCA 1033	9
250043710	12	ZOCA 1034	10

08 decorative panels and custom sizes material de revestimiento y confecciones especiales matériau de revêtement et confections spéciales

p.272 Flat finish materials
Material de revestimiento liso
Matériau de revêtement lisse

p.274 Reductions
Reducciones
Réductions

p.277 Without drill holes
Sin mecanizado
Non mécanisé

decorative panels
material de revestimiento
matériau de revêtement

Flat finish materials
Material de revestimiento liso
Matériau de revêtement lisse

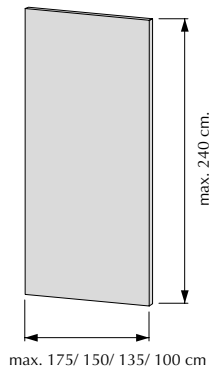

Flat finish material.
Two-faced finish material.
Price per square meter, minimum price 0.25 m².
Maximum measures:
R 1: - cm.
R 2: - cm.
R 3: - cm.

Material de revestimiento liso.
Material acabado a 2 caras.
Precio por metro cuadrado, precio mínimo 0,25 m².
Medidas maximas:
R 1: - cm.
R 2: - cm.
R 3: - cm.

Matériau de revêtement lisse.
Matériau finition double face.
Prix per metre carre, prix minimum 0,25 m².
Dimensions maximales:
R 1: - cm.
R 2: - cm.
R 3: - cm.

Wood imitation:
Imitación madera:
Imitation bois:

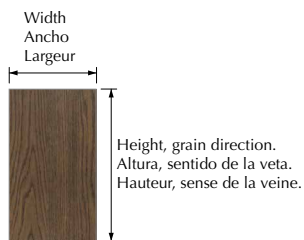

C. PLANIT: -

19 Thickness / espesor / épaisseur

SAP	Surface (m2)		R1		R2		R3	
	Superficie (m2)	Surface (m2)						
700022340	0,25 < 0,5	MRVL 0877	160	MRVR 0877	205	MRVE 0877	320	
700022341	0,51 < 1	MRVL 0878	125	MRVR 0878	174	MRVE 0878	280	
700022342	1,1 +	MRVL 0879	115	MRVR 0879	150	MRVE 0879	245	

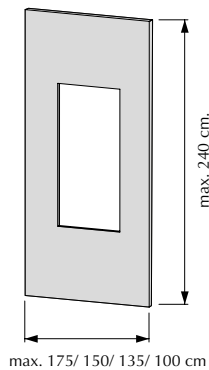

Finish materials with interior mechanized.
Two-faced finish material.
Price per square meter, minimum price 0.25 m².
Maximum measures:
R 1: - cm.
R 2: - cm.
R 3: - cm.
NOTE:
-Attach drawing with mechanized measures.

Material de revestimiento con mecanizado interior.
Material acabado a 2 caras.
Precio por metro cuadrado, precio mínimo 0,25 m².
Medidas maximas:
R 1: - cm.
R 2: - cm.
R 3: - cm.
NOTA:
-Adjuntar plano con medidas del mecanizado.

Matériau de revêtement avec mécanisation intérieur.
Matériau finition double face.
Prix per metre carre, prix minimum 0,25 m².
Dimensions maximales:
R 1: - cm.
R 2: - cm.
R 3: - cm.
REMARQUE:
-Attachez le dessin avec les mesures de mécanisation.

Wood imitation:
Imitación madera:
Imitation bois:

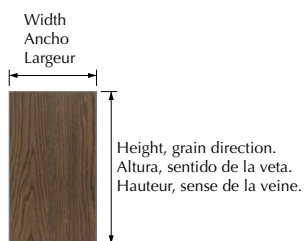

C. PLANIT: -

19 Thickness / espesor / épaisseur

SAP	Surface (m2)		R1		R2		R3	
	Superficie (m2)	Surface (m2)						
700022343	0,25 < 0,5	MRVL 0880	273	MRVR 0880	341	MRVE 0880	459	
700022344	0,51 < 1	MRVL 0881	241	MRVR 0881	294	MRVE 0881	399	
700022345	1,1 +	MRVL 0882	232	MRVR 0882	270	MRVE 0882	364	

decorative panels
material de revestimiento
matériau de revêtement

Flat finish materials
Material de revestimiento liso
Matériau de revêtement lisse

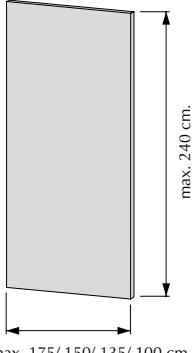

Flat finish material.
1 60° mitered-mechanized edge.
Two-faced finish material.
Price per square meter, minimum price 0.25 m².
Maximum measures:
R 1: - cm.
R 2: - cm.
R 3: - cm.
NOTE:
-The mechanized is performed on the side indicated as height.

Material de revestimiento liso.
1 canto mecanizado a 60°.
Material acabado a 2 caras.
Precio por metro cuadrado, precio mínimo 0,25 m².
Medidas maximas:
R 1: - cm.
R 2: - cm.
R 3: - cm.
NOTE:
-El mecanizado se realiza en costado indicado como altura.

Matériau de revêtement lisse.
1 chant usiné coupe en 60°.
Matériau finition double face.
Prix per metre carre, prix minimum 0,25 m².
Dimensions maximales:
R 1: - cm.
R 2: - cm.
R 3: - cm.
REMARQUE:
-L'usinage est réalisé sur le côté indiqué par la hauteur.

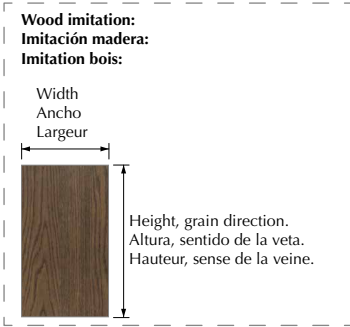

1 60° mitered-mechanized edge.
1 canto mecanizado a 60°.
1 chant usiné coupe en 60°.

C. PLANIT: -

19 Thickness / espesor / épaisseur

SAP	Surface (m2)		R1		R2		R3	
	Superficie (m2)	Surface (m2)						
700022443	0,25 < 0,5		MRVL 0895	235	MRVR 0895	280	MRVE 0895	395
700022444	0,51 < 1		MRVL 0896	200	MRVR 0896	249	MRVE 0896	355
700022445	1,1 +		MRVL 0897	190	MRVR 0897	225	MRVE 0897	320

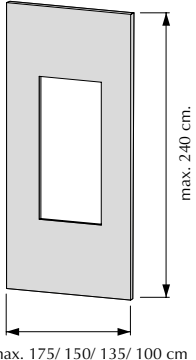

Finish materials with interior mechanized.
1 60° mitered-mechanized edge.
Two-faced finish material.
Price per square meter, minimum price 0.25 m².
Maximum measures:
R 1: - cm.
R 2: - cm.
R 3: - cm.
NOTE:
-The mechanized is performed on the side indicated as height.
-Attach drawing with mechanized measures.

Material de revestimiento con mecanizado interior.
1 canto mecanizado a 60°.
Material acabado a 2 caras.
Precio por metro cuadrado, precio mínimo 0,25 m².
Medidas maximas:
R 1: - cm.
R 2: - cm.
R 3: - cm.
NOTE:
-El mecanizado se realiza en costado indicado como altura.
-Adjuntar plano con medidas del mecanizado.

Matériau de revêtement avec mécanisation intérieur.
1 chant usiné coupe en 60°.
Matériau finition double face.
Prix per metre carre, prix minimum 0,25 m².
Dimensions maximales:
R 1: - cm.
R 2: - cm.
R 3: - cm.
REMARQUE:
-L'usinage est réalisé sur le côté indiqué par la hauteur.
-Attachez le dessin avec les mesures de mécanisation.

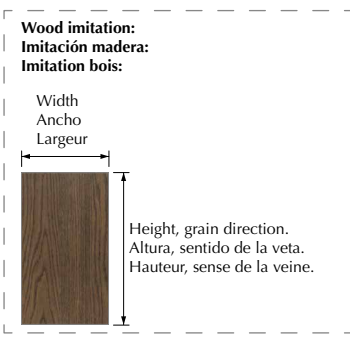

1 60° mitered-mechanized edge.
1 canto mecanizado a 60°.
1 chant usiné coupe en 60°.

C. PLANIT: -

19 Thickness / espesor / épaisseur

SAP	Surface (m2)		R1		R2		R3	
	Superficie (m2)	Surface (m2)						
700022446	0,25 < 0,5		MRVL 0898	373	MRVR 0898	461	MRVE 0898	548
700022447	0,51 < 1		MRVL 0899	306	MRVR 0899	369	MRVE 0899	446
700022448	1,1 +		MRVL 0900	270	MRVR 0900	309	MRVE 0900	351

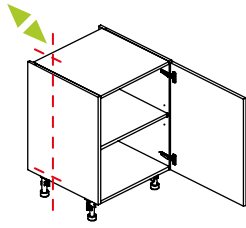

REMARKS

Depth remarks:
Always indicate carcass measures.
Minimum carcass depth, 20 cm.
In carcasses less than 35 cm, only the front legs will be fitted.
In 5 cm. multiples.

INDICACIONES

Indicaciones para ancho:
Indicar siempre medidas del casco.
Profundidad mínima del casco 20 cm.
Para cascos con profundidad menor de 35 cm., solo se colocaran las patas delanteras.
En múltiplos de 5 cm.

INDICATIONS

Indications profondeur:
Toujours indiquer les mesures du caisson.
Profondeur minimale de la caisse 20 cm.
Pour les caisses de profondeur inférieure a 35 cm, seul les pieds avant seront installés.
En multiples de 5 cm.

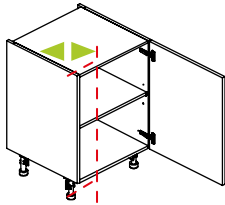

Width remarks:
This option is only available for flat doors.
Minimum carcass width, 20 cm.

Indicaciones para ancho:
Esta opción solo está disponible para puertas lisas.
Ancho mínimo de casco 20 cm.
En múltiplos de 5 cm.

Indications largeur:
Seulement disponible pour les modules avec portes.
Largeur minimale de la caisse 20 cm.
En multiples de 5 cm.

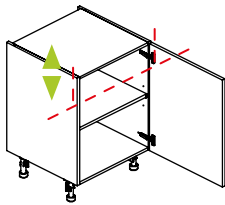

Height remarks:
The heights permitted must be those of standard doors.

Indicaciones para altura:
Las alturas permitidas deben coincidir con las medidas de puertas estándar.
En múltiplos de 5 cm.

Indications hauteur:
Les hauteurs permises doivent correspondre aux dimensions des portes standard.
En multiples de 5 cm.

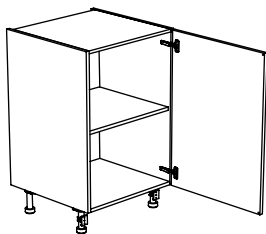

Base unit with door.
1 door.
1 shelf.

Módulo bajo con puerta.
1 puerta.
1 balda.

Modules bas avec porte.
1 porte.
1 étagère.

Availability / disponibilidad / disponibilité:

	*X		

*X It requires standard unit measures.
Requiere medidas estándar de módulo.
Il nécessite des mesures standard de modules.

SAP	Code Código Code	Opening Apertura Ouverture	0	1	2	3	4	5	6	7	8	9	10
700022074	BP 0813	L / R	391	436	-	496	522	557	-	614	-	-	-

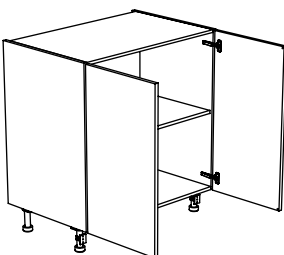

Base unit with door.
2 doors.
1 shelf.

Módulo bajo con puerta.
2 puertas.
1 balda.

Modules bas avec porte.
2 portes.
1 étagère.

Availability / disponibilidad / disponibilité:

	*X		

*X It requires standard unit measures.
Requiere medidas estándar de módulo.
Il nécessite des mesures standard de modules.

SAP	Code Código Code	Opening Apertura Ouverture	0	1	2	3	4	5	6	7	8	9	10
700022075	BP 0814	-	485	587	-	679	733	798	-	887	-	-	-

Custom sizes
Confecciones especiales
Confections spéciales

Reductions
Reducciones
Réductions

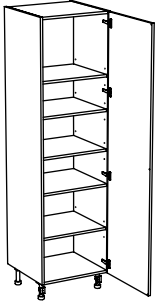

Tower unit with door.
1 door.
1 fixed shelf.
Number of shelves depending on unit height.

Módulo columna con puerta.
1 puerta.
1 balda fija.
Número de baldas en función de la altura del módulo.

Modules colonne avec porte.
1 porte.
1 étagère fixe.
Nombre d'étagères en fonction de la hauteur del module.

Availability / disponibilidad / disponibilité:

		*X		

*X It requires standard unit measures.
Requiere medidas estándar de módulo.
Il nécessite des mesures standard de modules.

SAP	Code Código Code	Opening Apertura Ouverture	0	1	2	3	4	5	6	7	8	9	10
			700022076	CP 0815	L / R	775	891	-	1028	1087	1144	-	1269

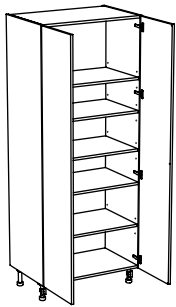

Tower unit with door.
2 doors.
1 fixed shelf.
Number of shelves depending on unit height.

Módulo columna con puerta.
2 puertas.
1 balda fija.
Número de baldas en función de la altura del módulo.

Modules colonne avec porte.
2 portes.
1 étagère fixe.
Nombre d'étagères en fonction de la hauteur del module.

Availability / disponibilidad / disponibilité:

		*X		

*X It requires standard unit measures.
Requiere medidas estándar de módulo.
Il nécessite des mesures standard de modules.

SAP	Code Código Code	Opening Apertura Ouverture	0	1	2	3	4	5	6	7	8	9	10
			700022077	CP 0816	-	997	1252	-	1478	1591	1710	-	1961

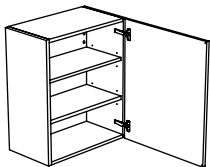

Wall unit with doors.
1 door.
Number of shelves depending on unit height.

Módulo alto con puertas.
1 puerta.
Número de baldas en función de la altura del módulo.

Module haut avec portes.
1 porte.
Nombre d'étagères en fonction de la hauteur del module.

Availability / disponibilidad / disponibilité:

		*X		

*X It requires standard unit measures.
Requiere medidas estándar de módulo.
Il nécessite des mesures standard de modules.

SAP	Code Código Code	Opening Apertura Ouverture	0	1	2	3	4	5	6	7	8	9	10
			700022078	AP 0817	L / R	501	566	-	637	668	702	-	776

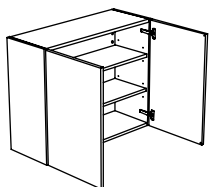

Wall unit with doors.
2 doors.
Number of shelves depending on unit height.

Módulo alto con puertas.
2 puertas.
Número de baldas en función de la altura del módulo.

Module haut avec portes.
2 portes.
Nombre d'étagères en fonction de la hauteur del module.

Availability / disponibilidad / disponibilité:

		*X		

*X It requires standard unit measures.
Requiere medidas estándar de módulo.
Il nécessite des mesures standard de modules.

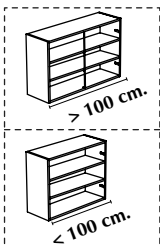

SAP	Code Código Code	Opening Apertura Ouverture	0	1	2	3	4	5	6	7	8	9	10
			700022079	AP 0818	-	699	838	-	958	1014	1076	-	1208

Custom sizes
 Confecciones especiales
 Confections spéciales

Reductions
 Reducciones
 Réductions

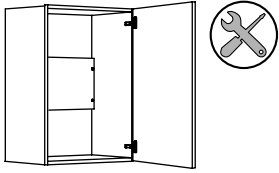

Wall unit with door for boiler.
 1 door.
 Minimum measures: 150 x 400 x 300 mm
 (width x height x depth).
 Maximum measures: 762 x 1460 x 700
 mm (width x height x depth).

Módulo alto con puerta para caldera.
 1 puerta.
 Medidas mínimas: 150 x 400 x 300 mm
 (ancho x alto x profundo).
 Medidas máximas: 762 x 1460 x 700 mm
 (ancho x alto x profundo).

Module haut avec porte pour chaudière.
 1 porte.
 Dimensions minimales: 150 x 400 x 300
 mm (largeur x hauteur x prof.).
 Dimensions maximales: 762 x 1460 x 700
 mm (largeur x hauteur x prof.).

Availability / disponibilidad / disponibilité:

	*X		

*X It requires standard unit measures.
 Requiere medidas estándar de módulo.
 Il nécessite des mesures standard de modules.

SAP	Code Código Code	Opening Apertura Ouverture											
			0	1	2	3	4	5	6	7	8	9	10
700022080	AC 0819	L / R	501	566	-	637	668	702	-	776	-	-	-

Custom sizes
Confecciones especiales
Confections spéciales

Without drill holes
Sin mecanizado
Non mécanisé

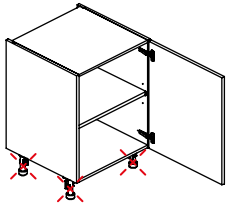

Without drill holes for legs.

Sin mecanizado patas.

Non mécanisé pour pieds.

Type of unit Tipo de módulo Type de module	Code Código Code	Points Puntos Points
Base - Tower units Bajos - Columnas Bas - Colonnes	RCG 1300	90

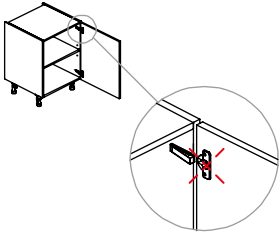

Without drill holes for hinge on door.

Sin mecanizado bisagra en puerta.

Non mécanisé pour charnière sur porte.

Type of unit Tipo de módulo Type de module	Code Código Code	Points Puntos Points
All units Todos los módulos Tous les modules	RCG 1302	50

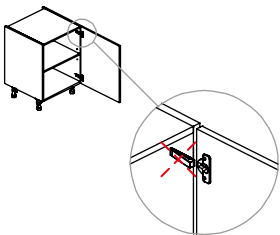

Without drill holes for hinge base on carcass.

Sin mecanizado base bisagra en casco.

Non mécanisé pour base charnière sur caisse.

Type of unit Tipo de módulo Type de module	Code Código Code	Points Puntos Points
All units Todos los módulos Tous les modules	RCG 1303	50

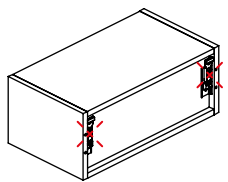

Without drill holes for hanger pieces.

Sin mecanizado colgadores.

Non mécanisé pour ancrages.

Type of unit Tipo de módulo Type de module	Code Código Code	Points Puntos Points
All units Todos los módulos Tous les modules	RCG 1304	90

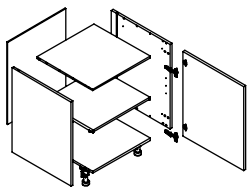

Flat box service option.
Served without self-assembling system, for built-in glueing.

Opción módulo desmontado.
Se suministra sin sistema de montaje por excéntricas para encolar en obra.

Option module démonté.
Fourni sans système d'installation par excentriques pour coller lors de l'installation.

Type of unit Tipo de módulo Type de module	Code Código Code	Points Puntos Points
All units Todos los módulos Tous les modules	RCG 1305	1

09 replacement and miscellaneous items repuestos y elementos sueltos pièces de rechange et éléments isolés

- p.280** Fronts and doors
Frentes y puertas
Façades et portes
- p.286** Interior shelves
Baldas interiores
Étagères intérieures
- p.288** Drawers and deep drawers
Cajones y extraíbles
Tiroirs et extractibles

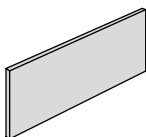

Front.
Height, **18 cm.**

Frente.
Alto, **18 cm.**

Façade.
Haut, **18 cm.**

18 height / altura / hauteur

SAP	Code Código Code	Width Ancho Largeur											
			0	1	2	3	4	5	6	7	8	9	10
700022449	VPT 0901	30	-	39	-	49	71	76	-	87	-	-	-
700022450	VPT 0901	40	-	40	-	50	74	79	-	92	-	-	-
700022451	VPT 0901	45	-	41	-	51	75	81	-	94	-	-	-
700022452	VPT 0901	50	-	42	-	52	77	82	-	97	-	-	-
700022453	VPT 0901	60	-	43	-	54	79	86	-	99	-	-	-
700022454	VPT 0901	76,2	-	44	-	56	82	88	-	102	-	-	-
700022455	VPT 0901	80	-	45	-	57	85	93	-	109	-	-	-
700022456	VPT 0901	90	-	46	-	60	90	98	-	116	-	-	-
700022457	VPT 0901	100	-	47	-	61	92	100	-	122	-	-	-
700022458	VPT 0901	120	-	49	-	64	98	109	-	133	-	-	-

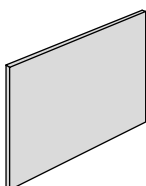

Front.
Height, **24 cm.**

Frente.
Alto, **24 cm.**

Façade.
Haut, **24 cm.**

24 height / altura / hauteur

SAP	Code Código Code	Width Ancho Largeur											
			0	1	2	3	4	5	6	7	8	9	10
700022459	VPT 0902	30	-	42	-	53	74	81	-	95	-	-	-
700022460	VPT 0902	40	-	43	-	56	77	86	-	102	-	-	-
700022461	VPT 0902	45	-	45	-	59	81	91	-	108	-	-	-
700022462	VPT 0902	50	-	46	-	60	82	93	-	111	-	-	-
700022463	VPT 0902	60	-	47	-	63	86	98	-	116	-	-	-
700022464	VPT 0902	76,2	-	49	-	67	90	100	-	119	-	-	-
700022465	VPT 0902	80	-	50	-	68	92	108	-	132	-	-	-
700022466	VPT 0902	90	-	51	-	71	95	113	-	136	-	-	-
700022467	VPT 0902	100	-	53	-	72	98	116	-	140	-	-	-
700022468	VPT 0902	120	-	56	-	78	106	129	-	161	-	-	-

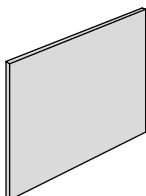

Front.
Height, **36 cm.**

Frente.
Alto, **36 cm.**

Façade.
Haut, **36 cm.**

36 height / altura / hauteur

SAP	Code Código Code	Width Ancho Largeur											
			0	1	2	3	4	5	6	7	8	9	10
700022469	VPT 0903	30	-	45	-	59	79	89	-	105	-	-	-
700022470	VPT 0903	40	-	47	-	61	82	95	-	114	-	-	-
700022471	VPT 0903	45	-	48	-	63	84	99	-	119	-	-	-
700022472	VPT 0903	50	-	49	-	66	86	102	-	123	-	-	-
700022473	VPT 0903	60	-	51	-	70	89	108	-	132	-	-	-
700022474	VPT 0903	76,2	-	54	-	74	90	111	-	135	-	-	-
700022475	VPT 0903	80	-	55	-	75	100	121	-	148	-	-	-
700022476	VPT 0903	90	-	65	-	88	111	133	-	165	-	-	-
700022477	VPT 0903	100	-	67	-	92	117	137	-	174	-	-	-
700022478	VPT 0903	120	-	76	-	108	130	150	-	194	-	-	-

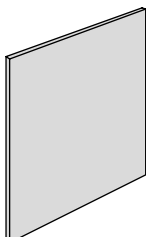

Front.
Height, **42 cm.**

Frente.
Alto, **42 cm.**

Façade.
Haut, **42 cm.**

42 height / altura / hauteur

SAP	Code Código Code	Width Ancho Largeur											
			0	1	2	3	4	5	6	7	8	9	10
700022479	VPT 0904	30	-	46	-	61	80	92	-	109	-	-	-
700022480	VPT 0904	40	-	48	-	64	83	99	-	119	-	-	-
700022481	VPT 0904	45	-	49	-	67	86	102	-	124	-	-	-
700022482	VPT 0904	50	-	50	-	68	87	106	-	129	-	-	-
700022483	VPT 0904	60	-	53	-	73	91	113	-	139	-	-	-
700022484	VPT 0904	76,2	-	64	-	88	103	119	-	150	-	-	-
700022485	VPT 0904	80	-	65	-	89	113	133	-	166	-	-	-
700022486	VPT 0904	90	-	68	-	94	115	138	-	172	-	-	-
700022487	VPT 0904	100	-	75	-	104	117	146	-	185	-	-	-
700022488	VPT 0904	120	-	84	-	118	139	164	-	213	-	-	-

Front.
Height, 48 cm.

Frente.
Alto, 48 cm.

Façade.
Haut, 48 cm.

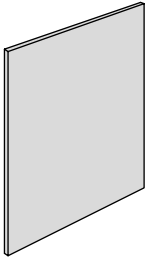

48 height / altura / hauteur

SAP	Code Código Code	Width Ancho Largeur											
			0	1	2	3	4	5	6	7	8	9	10
700022489	VPT 0905	30	-	46	-	62	80	93	-	111	-	-	-
700022490	VPT 0905	40	-	49	-	66	84	100	-	121	-	-	-
700022491	VPT 0905	45	-	50	-	69	86	104	-	127	-	-	-
700022492	VPT 0905	50	-	51	-	70	88	108	-	132	-	-	-
700022493	VPT 0905	60	-	54	-	74	92	116	-	143	-	-	-
700022494	VPT 0905	76,2	-	66	-	90	105	122	-	157	-	-	-
700022495	VPT 0905	80	-	67	-	92	112	131	-	166	-	-	-
700022496	VPT 0905	90	-	74	-	104	124	142	-	182	-	-	-
700022497	VPT 0905	100	-	76	-	109	128	150	-	195	-	-	-
700022498	VPT 0905	120	-	86	-	122	143	169	-	219	-	-	-

Front.
Height, 60 cm.

Frente.
Alto, 60 cm.

Façade.
Haut, 60 cm.

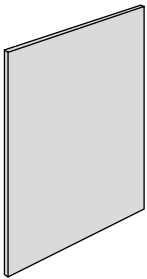

60 height / altura / hauteur

SAP	Code Código Code	Width Ancho Largeur											
			0	1	2	3	4	5	6	7	8	9	10
700022499	VPT 0906	30	-	49	-	65	83	100	-	120	-	-	-
700022500	VPT 0906	40	-	52	-	71	88	109	-	133	-	-	-
700022501	VPT 0906	45	-	54	-	74	90	114	-	140	-	-	-
700022502	VPT 0906	50	-	60	-	82	102	120	-	150	-	-	-
700022503	VPT 0906	60	-	66	-	92	109	129	-	165	-	-	-
700022504	VPT 0906	76,2	-	76	-	105	119	137	-	175	-	-	-
700022505	VPT 0906	80	-	78	-	109	130	149	-	193	-	-	-
700022506	VPT 0906	90	-	86	-	121	141	164	-	212	-	-	-
700022507	VPT 0906	100	-	94	-	126	144	175	-	229	-	-	-
700022508	VPT 0906	120	-	108	-	146	172	205	-	269	-	-	-

Front.
Height, 70 cm.

Frente.
Alto, 70 cm.

Façade.
Haut, 70 cm.

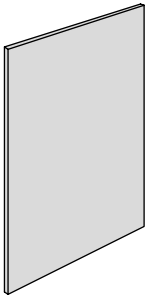

70 height / altura / hauteur

SAP	Code Código Code	Width Ancho Largeur											
			0	1	2	3	4	5	6	7	8	9	10
700022509	VPT 0907	30	-	51	-	68	85	104	-	126	-	-	-
700022510	VPT 0907	40	-	54	-	74	95	115	-	141	-	-	-
700022511	VPT 0907	45	-	64	-	87	106	126	-	157	-	-	-
700022512	VPT 0907	50	-	66	-	91	109	129	-	163	-	-	-
700022513	VPT 0907	60	-	74	-	105	123	140	-	179	-	-	-
700022514	VPT 0907	76,2	-	85	-	118	134	152	-	194	-	-	-
700022515	VPT 0907	80	-	86	-	121	138	162	-	214	-	-	-
700022516	VPT 0907	90	-	98	-	132	155	179	-	240	-	-	-
700022517	VPT 0907	100	-	107	-	144	162	182	-	242	-	-	-
700022518	VPT 0907	120	-	114	-	157	188	222	-	291	-	-	-

Front.
Height, 72 cm.

Frente.
Alto, 72 cm.

Façade.
Haut, 72 cm.



72 height / altura / hauteur

SAP	Code Código Code	Width Ancho Largeur											
			0	1	2	3	4	5	6	7	8	9	10
700022519	VPT 0908	30	-	51	-	69	85	105	-	127	-	-	-
700022520	VPT 0908	38,1	-	54	-	74	90	108	-	132	-	-	-
700022521	VPT 0908	40	-	55	-	75	95	116	-	143	-	-	-
700022522	VPT 0908	45	-	65	-	88	106	127	-	158	-	-	-
700022523	VPT 0908	50	-	66	-	92	109	128	-	164	-	-	-
700022524	VPT 0908	60	-	75	-	107	126	144	-	181	-	-	-



Front.
Height, **78 cm.**

Frente.
Alto, **78 cm.**

Façade.
Haut, **78 cm.**

78 height / altura / hauteur

SAP	Code Código Code	Width Ancho Largeur											
			0	1	2	3	4	5	6	7	8	9	10
700022525	VPT 0909	30	-	52	-	71	86	108	-	131	-	-	-
700022526	VPT 0909	38,1	-	55	-	76	92	112	-	134	-	-	-
700022527	VPT 0909	40	-	64	-	87	107	125	-	156	-	-	-
700022528	VPT 0909	45	-	66	-	91	110	129	-	163	-	-	-
700022529	VPT 0909	50	-	68	-	95	111	132	-	166	-	-	-
700022530	VPT 0909	60	-	77	-	108	126	146	-	188	-	-	-
700022531	VPT 0909	76,2	-	88	-	120	135	157	-	205	-	-	-
700022532	VPT 0909	80	-	98	-	131	152	177	-	237	-	-	-
700022533	VPT 0909	90	-	107	-	144	170	198	-	259	-	-	-
700022534	VPT 0909	100	-	111	-	151	174	214	-	282	-	-	-
700022535	VPT 0909	120	-	127	-	175	203	241	-	321	-	-	-



Front.
Height, **84 cm.**

Frente.
Alto, **84 cm.**

Façade.
Haut, **84 cm.**

84 height / altura / hauteur

SAP	Code Código Code	Width Ancho Largeur											
			0	1	2	3	4	5	6	7	8	9	10
700022536	VPT 0910	30	-	53	-	73	87	110	-	135	-	-	-
700022537	VPT 0910	38,1	-	65	-	88	102	119	-	150	-	-	-
700022538	VPT 0910	40	-	66	-	89	110	129	-	161	-	-	-
700022539	VPT 0910	45	-	68	-	94	112	132	-	164	-	-	-
700022540	VPT 0910	50	-	75	-	105	122	139	-	177	-	-	-
700022541	VPT 0910	60	-	84	-	117	134	156	-	200	-	-	-

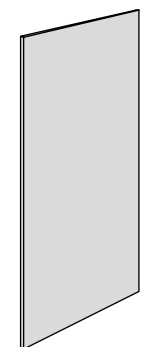

Front.
Height, **96 cm.**

Frente.
Alto, **96 cm.**

Façade.
Haut, **96 cm.**

96 height / altura / hauteur

SAP	Code Código Code	Width Ancho Largeur											
			0	1	2	3	4	5	6	7	8	9	10
700022542	VPT 0911	30	-	55	-	75	96	115	-	142	-	-	-
700022543	VPT 0911	38,1	-	67	-	93	105	121	-	153	-	-	-
700022544	VPT 0911	40	-	68	-	94	109	128	-	164	-	-	-
700022545	VPT 0911	45	-	75	-	107	124	140	-	179	-	-	-
700022546	VPT 0911	50	-	78	-	110	128	146	-	189	-	-	-
700022547	VPT 0911	60	-	87	-	118	140	159	-	213	-	-	-

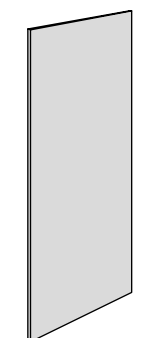

Front.
Height, **108 cm.**

Frente.
Alto, **108 cm.**

Façade.
Haut, **108 cm.**

108 height / altura / hauteur

SAP	Code Código Code	Width Ancho Largeur											
			0	1	2	3	4	5	6	7	8	9	10
700022803	VPT 1035	30	-	61	-	84	104	122	-	152	-	-	-
700022804	VPT 1035	38,1	-	72	-	100	113	130	-	165	-	-	-
700022805	VPT 1035	40	-	73	-	102	118	137	-	176	-	-	-
700022806	VPT 1035	45	-	81	-	115	132	150	-	192	-	-	-
700022807	VPT 1035	50	-	86	-	118	137	157	-	206	-	-	-
700022808	VPT 1035	60	-	98	-	132	153	176	-	235	-	-	-

Front.
Height, **120 cm.**

Frente.
Alto, **120 cm.**

Façade.
Haut, **120 cm.**

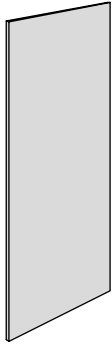

120 height / altura / hauteur

SAP	Code Código Code	Width Ancho Largeur											
			0	1	2	3	4	5	6	7	8	9	10
700022548	VPT 0912	30	-	67	-	93	111	128	-	162	-	-	-
700022549	VPT 0912	38,1	-	77	-	106	120	138	-	176	-	-	-
700022550	VPT 0912	40	-	78	-	110	127	146	-	188	-	-	-
700022551	VPT 0912	45	-	86	-	122	139	159	-	205	-	-	-
700022552	VPT 0912	50	-	94	-	126	146	167	-	222	-	-	-
700022553	VPT 0912	60	-	108	-	146	166	192	-	257	-	-	-

Front.
Height, **128 cm.**

Frente.
Alto, **128 cm.**

Façade.
Haut, **128 cm.**



128 height / altura / hauteur

SAP	Code Código Code	Width Ancho Largeur											
			0	1	2	3	4	5	6	7	8	9	10
700022554	VPT 0913	30	-	69	-	95	109	128	-	164	-	-	-
700022555	VPT 0913	38,1	-	79	-	111	122	140	-	182	-	-	-
700022556	VPT 0913	40	-	85	-	119	137	156	-	199	-	-	-
700022557	VPT 0913	45	-	88	-	121	139	158	-	212	-	-	-
700022558	VPT 0913	50	-	99	-	133	155	177	-	236	-	-	-
700022559	VPT 0913	60	-	110	-	151	172	198	-	266	-	-	-

Front.
Height, **132 cm.**

Frente.
Alto, **132 cm.**

Façade.
Haut, **132 cm.**



132 height / altura / hauteur

SAP	Code Código Code	Width Ancho Largeur											
			0	1	2	3	4	5	6	7	8	9	10
700022560	VPT 0914	30	-	69	-	97	110	130	-	166	-	-	-
700022561	VPT 0914	38,1	-	85	-	118	131	149	-	190	-	-	-
700022562	VPT 0914	40	-	86	-	121	138	158	-	202	-	-	-
700022563	VPT 0914	45	-	89	-	123	140	161	-	215	-	-	-
700022564	VPT 0914	50	-	100	-	135	156	179	-	240	-	-	-
700022565	VPT 0914	60	-	112	-	153	175	201	-	271	-	-	-

Front.
Height, **144 cm.**

Frente.
Alto, **144 cm.**

Façade.
Haut, **144 cm.**

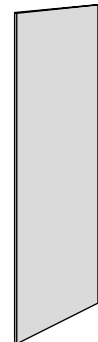

144 height / altura / hauteur

SAP	Code Código Code	Width Ancho Largeur											
			0	1	2	3	4	5	6	7	8	9	10
700022566	VPT 0915	30	-	76	-	108	124	140	-	179	-	-	-
700022567	VPT 0915	38,1	-	87	-	117	132	153	-	199	-	-	-
700022568	VPT 0915	40	-	88	-	119	138	158	-	212	-	-	-
700022569	VPT 0915	45	-	100	-	134	155	178	-	237	-	-	-
700022570	VPT 0915	50	-	108	-	146	165	192	-	256	-	-	-
700022571	VPT 0915	60	-	115	-	160	181	210	-	284	-	-	-



Front.
Height, **150 cm.**

Frente.
Alto, **150 cm.**

Façade.
Haut, **150 cm.**

150 height / altura / hauteur

SAP	Code Código Code	Width Ancho Largeur											
			0	1	2	3	4	5	6	7	8	9	10
700022572	VPT 0916	30	-	77	-	110	125	142	-	182	-	-	-
700022573	VPT 0916	38,1	-	88	-	119	133	153	-	203	-	-	-
700022574	VPT 0916	40	-	95	-	127	145	166	-	221	-	-	-
700022575	VPT 0916	45	-	101	-	137	157	181	-	242	-	-	-
700022576	VPT 0916	50	-	110	-	149	170	196	-	262	-	-	-
700022577	VPT 0916	60	-	122	-	169	191	220	-	296	-	-	-



Front.
Height, **152 cm.**

Frente.
Alto, **152 cm.**

Façade.
Haut, **152 cm.**

152 height / altura / hauteur

SAP	Code Código Code	Width Ancho Largeur											
			0	1	2	3	4	5	6	7	8	9	10
700022578	VPT 0917	30	-	78	-	111	128	143	-	183	-	-	-
700022579	VPT 0917	38,1	-	89	-	120	136	157	-	205	-	-	-
700022580	VPT 0917	40	-	98	-	131	152	173	-	229	-	-	-
700022581	VPT 0917	45	-	102	-	138	157	182	-	244	-	-	-
700022582	VPT 0917	50	-	110	-	150	171	197	-	264	-	-	-
700022583	VPT 0917	60	-	126	-	173	198	227	-	306	-	-	-



Front.
Height, **156 cm.**

Frente.
Alto, **156 cm.**

Façade.
Haut, **156 cm.**

156 height / altura / hauteur

SAP	Code Código Code	Width Ancho Largeur											
			0	1	2	3	4	5	6	7	8	9	10
700022584	VPT 0918	30	-	79	-	110	126	145	-	186	-	-	-
700022585	VPT 0918	38,1	-	90	-	121	137	159	-	208	-	-	-
700022586	VPT 0918	40	-	99	-	133	153	175	-	233	-	-	-
700022587	VPT 0918	45	-	108	-	145	164	190	-	253	-	-	-
700022588	VPT 0918	50	-	112	-	152	172	199	-	268	-	-	-
700022589	VPT 0918	60	-	127	-	176	199	230	-	311	-	-	-



Front.
Height, **164 cm.**

Frente.
Alto, **164 cm.**

Façade.
Haut, **164 cm.**

164 height / altura / hauteur

SAP	Code Código Code	Width Ancho Largeur											
			0	1	2	3	4	5	6	7	8	9	10
700022590	VPT 0919	30	-	80	-	113	130	151	-	191	-	-	-
700022591	VPT 0919	38,1	-	99	-	133	151	173	-	225	-	-	-
700022592	VPT 0919	40	-	101	-	136	155	179	-	239	-	-	-
700022593	VPT 0919	45	-	110	-	149	169	194	-	260	-	-	-
700022594	VPT 0919	50	-	114	-	156	176	204	-	275	-	-	-
700022595	VPT 0919	60	-	130	-	180	206	240	-	320	-	-	-

Front.
Height, **198 cm.**

Frente.
Alto, **198 cm.**

Façade.
Haut, **198 cm.**



198 height / altura / hauteur

SAP	Code Código Code	Width Ancho Largeur											
			0	1	2	3	4	5	6	7	8	9	10
700022596	VPT 0920	30	-	91	-	122	140	161	-	216	-	-	-
700022597	VPT 0920	38,1	-	111	-	151	169	195	-	256	-	-	-
700022598	VPT 0920	40	-	113	-	155	174	201	-	270	-	-	-
700022599	VPT 0920	45	-	118	-	164	186	213	-	289	-	-	-
700022600	VPT 0920	50	-	131	-	182	206	241	-	321	-	-	-
700022601	VPT 0920	60	-	150	-	211	235	276	-	369	-	-	-

Front.
Height, **210 cm.**

Frente.
Alto, **210 cm.**

Façade.
Haut, **210 cm.**



210 height / altura / hauteur

SAP	Code Código Code	Width Ancho Largeur											
			0	1	2	3	4	5	6	7	8	9	10
700022602	VPT 0921	30	-	101	-	135	155	177	-	235	-	-	-
700022603	VPT 0921	38,1	-	114	-	156	172	198	-	264	-	-	-
700022604	VPT 0921	40	-	116	-	159	179	207	-	279	-	-	-
700022605	VPT 0921	45	-	129	-	178	200	236	-	312	-	-	-
700022606	VPT 0921	50	-	134	-	188	214	249	-	332	-	-	-
700022607	VPT 0921	60	-	154	-	218	240	286	-	382	-	-	-

Front.
Height, **220 cm.**

Frente.
Alto, **220 cm.**

Façade.
Haut, **220 cm.**



220 height / altura / hauteur

SAP	Code Código Code	Width Ancho Largeur											
			0	1	2	3	4	5	6	7	8	9	10
700022608	VPT 0922	30	-	103	-	138	157	181	-	241	-	-	-
700022609	VPT 0922	38,1	-	116	-	160	178	203	-	272	-	-	-
700022610	VPT 0922	40	-	118	-	163	182	212	-	287	-	-	-
700022611	VPT 0922	45	-	132	-	183	207	242	-	321	-	-	-
700022612	VPT 0922	50	-	147	-	203	229	266	-	352	-	-	-
700022613	VPT 0922	60	-	167	-	234	255	304	-	404	-	-	-

Front.
Height, **234 cm.**

Frente.
Alto, **234 cm.**

Façade.
Haut, **234 cm.**



234 height / altura / hauteur

SAP	Code Código Code	Width Ancho Largeur											
			0	1	2	3	4	5	6	7	8	9	10
700022614	VPT 0923	30	-	110	-	148	165	191	-	254	-	-	-
700022615	VPT 0923	38,1	-	119	-	165	182	209	-	282	-	-	-
700022616	VPT 0923	40	-	130	-	178	201	231	-	311	-	-	-
700022617	VPT 0923	45	-	135	-	189	215	250	-	333	-	-	-
700022618	VPT 0923	50	-	151	-	210	234	275	-	366	-	-	-
700022619	VPT 0923	60	-	172	-	243	264	314	-	420	-	-	-

Replacement
Repuestos
Pièces de rechange

Interior shelves
Baldas interiores
Étagères intérieures

Shelf for base, tower and wall unit.
To 35 cm depth units.
Not suitable shelf for wall modules.⊖

Balda para módulo bajo, columna y alto.
Para módulos de 35 cm de profundidad.
Balda no apta para módulos altos.⊖

Étagère pour module bas, colonne et haut.
Pour modules de 35 cm de profondeur.
Étagère non adaptée pour modules hauts.⊖

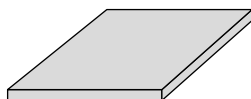

35 depth / profundidad / profondeur			
SAP	Code Código Code	Width Ancho Largeur	Carcass colour Color de casco Couleur de caisson
700022671	VAL 0973	30	30
700022672	VAL 0973	40	32
700022673	VAL 0973	45	33
700022674	VAL 0973	50	34
700022675	VAL 0973	60	35
700022676	VAL 0973	76,2	37
700022677	VAL 0973	80	38
700022678	VAL 0973	90	39
700022679	VAL 0973	⊖ 100	41
700022680	VAL 0973	⊖ 120	46

Shelf for base and tower unit
To 45 cm depth units

Balda para módulo bajo y columna.
Para módulos de 45 cm de profundidad

Étagère pour module bas et colonne
Pour modules de 45 cm de profondeur

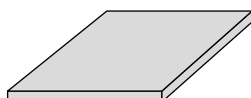

45 depth / profundidad / profondeur			
SAP	Code Código Code	Width Ancho Largeur	Carcass colour Color de casco Couleur de caisson
700022681	VAL 0974	30	32
700022682	VAL 0974	40	34
700022683	VAL 0974	45	35
700022684	VAL 0974	50	36
700022685	VAL 0974	60	38
700022686	VAL 0974	76,2	41
700022687	VAL 0974	80	44
700022688	VAL 0974	90	46
700022689	VAL 0974	100	48
700022690	VAL 0974	120	51

Shelf for base and tower unit.
To 61 cm depth units.

Balda para módulo bajo y columna.
Para módulos de 61 cm de profundidad.

Étagère pour module bas et colonne.
Pour modules de 61 cm de profondeur.

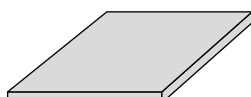

61 depth / profundidad / profondeur			
SAP	Code Código Code	Width Ancho Largeur	Carcass colour Color de casco Couleur de caisson
700022691	VAL 0975	30	34
700022692	VAL 0975	40	36
700022693	VAL 0975	45	37
700022694	VAL 0975	50	39
700022695	VAL 0975	60	43
700022696	VAL 0975	76,2	47
700022697	VAL 0975	80	48
700022698	VAL 0975	90	50
700022699	VAL 0975	100	53
700022700	VAL 0975	120	60

Shelf for wall unit.
To 61 cm depth units.
Not suitable shelf for wall modules.⊖

Balda para módulo alto.
Para módulos de 61 cm de profundidad.
Balda no apta para módulos altos.⊖

Étagère pour module haut.
Pour modules de 61 cm de profondeur.
Étagère non adaptée pour modules hauts.⊖

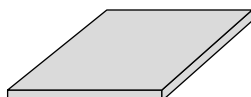

61 depth / profundidad / profondeur			
SAP	Code Código Code	Width Ancho Largeur	Carcass colour Color de casco Couleur de caisson
700022701	VAL 0976	30	34
700022702	VAL 0976	40	37
700022703	VAL 0976	45	38
700022704	VAL 0976	50	39
700022705	VAL 0976	60	44
700022706	VAL 0976	76,2	48
700022707	VAL 0976	80	49
700022708	VAL 0976	90	51
700022709	VAL 0976	⊖ 100	54
700022710	VAL 0976	⊖ 120	61

Replacement
Repuestos
Pièces de rechange

Interior shelves
Baldas interiores
Étagères intérieures

Shelf for wall unit.
To 35 cm depth units.
Fittings not included.

Balda para módulo alto.
Para módulos de 35 cm de profundidad.
Herrajes no incluidos.

Étagère pour module haut.
Pour modules de 35 cm de profondeur.
Ferrures non inclus.

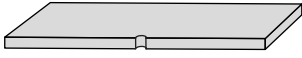

35 depth / profundidad / profondeur

SAP	Code Código Code	Width Ancho Largeur	Carcass colour Color de casco Couleur de caisson
700022711	VAL 0977	100	52
700022712	VAL 0977	120	58

Shelf for wall unit.
To 61 cm depth units.
Fittings not included.

Balda para módulo alto.
Para módulos de 61 cm de profundidad.
Herrajes no incluidos.

Étagère pour module haut.
Pour modules de 61 cm de profondeur.
Ferrures non inclus.

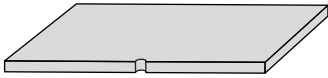

61 depth / profundidad / profondeur

SAP	Code Código Code	Width Ancho Largeur	Carcass colour Color de casco Couleur de caisson
700022713	VAL 0978	100	65
700022714	VAL 0978	120	72

Replacement
Repuestos
Pièces de rechange

Drawers and deep drawers
Cajones y extraíbles
Tiroirs et extractibles



Spare Scala drawer with runners.
Height, 9 cm.

Recambio de cajones Scala con guías.
Alto, 9 cm.

Rechange tiroir Scala, avec glissières.
Hauteur, 9 cm.

45 depth / profundidad / profondeur

SAP	Code Código Code	Width Ancho Largeur	Points Puntos Points
700022356	VHRJ 0884	30	186
700022357	VHRJ 0884	40	190
700022358	VHRJ 0884	45	191
700022359	VHRJ 0884	50	193
700022360	VHRJ 0884	60	196
700022361	VHRJ 0884	76,2	202
700022362	VHRJ 0884	80	203
700022363	VHRJ 0884	90	209
700022364	VHRJ 0884	100	212
700022365	VHRJ 0884	120	219

61 depth / profundidad / profondeur

SAP	Code Código Code	Width Ancho Largeur	Points Puntos Points
700022346	VHRJ 0883	30	180
700022347	VHRJ 0883	40	183
700022348	VHRJ 0883	45	185
700022349	VHRJ 0883	50	187
700022350	VHRJ 0883	60	191
700022351	VHRJ 0883	76,2	199
700022352	VHRJ 0883	80	200
700022353	VHRJ 0883	90	204
700022354	VHRJ 0883	100	208
700022355	VHRJ 0883	120	215

Spare Scala drawer with runners.
For PUSH system.
Height, 9 cm.

Recambio de cajones Scala con guías.
Para sistema PUSH.
Alto, 9 cm.

Rechange tiroir Scala, avec glissières.
Pour système PUSH.
Hauteur, 9 cm.

45 depth / profundidad / profondeur

SAP	Code Código Code	Width Ancho Largeur	Points Puntos Points
700022394	VHRJ 0888	30	294
700022395	VHRJ 0888	40	299
700022396	VHRJ 0888	45	303
700022397	VHRJ 0888	50	304
700022398	VHRJ 0888	60	307
700022399	VHRJ 0888	76,2	318
700022400	VHRJ 0888	80	319
700022401	VHRJ 0888	90	325

61 depth / profundidad / profondeur

SAP	Code Código Code	Width Ancho Largeur	Points Puntos Points
700022386	VHRJ 0887	30	288
700022387	VHRJ 0887	40	293
700022388	VHRJ 0887	45	296
700022389	VHRJ 0887	50	298
700022390	VHRJ 0887	60	302
700022391	VHRJ 0887	76,2	315
700022392	VHRJ 0887	80	316
700022393	VHRJ 0887	90	320



Spare Scala deep drawer with runners.
Height, 18,5 cm.

Recambio de gavetas Scala con guías.
Alto, 18,5 cm.

Rechange extractible Scala, avec glissières.
Hauteur, 18,5 cm.

45 depth / profundidad / profondeur

SAP	Code Código Code	Width Ancho Largeur	Points Puntos Points
700022376	VHRJ 0886	30	233
700022377	VHRJ 0886	40	237
700022378	VHRJ 0886	45	238
700022379	VHRJ 0886	50	240
700022380	VHRJ 0886	60	243
700022381	VHRJ 0886	76,2	248
700022382	VHRJ 0886	80	249
700022383	VHRJ 0886	90	255
700022384	VHRJ 0886	100	258
700022385	VHRJ 0886	120	263

61 depth / profundidad / profondeur

SAP	Code Código Code	Width Ancho Largeur	Points Puntos Points
700022366	VHRJ 0885	30	225
700022367	VHRJ 0885	40	228
700022368	VHRJ 0885	45	230
700022369	VHRJ 0885	50	232
700022370	VHRJ 0885	60	235
700022371	VHRJ 0885	76,2	244
700022372	VHRJ 0885	80	245
700022373	VHRJ 0885	90	248
700022374	VHRJ 0885	100	251
700022375	VHRJ 0885	120	258

Spare Scala deep drawer with runners.
For PUSH system.
Height, 18,5 cm.

Recambio de gavetas Scala con guías.
Para sistema PUSH.
Alto, 18,5 cm.

Rechange extractible Scala, avec glissières.
Pour système PUSH.
Hauteur, 18,5 cm.

45 depth / profundidad / profondeur

SAP	Code Código Code	Width Ancho Largeur	Points Puntos Points
700022410	VHRJ 0890	30	341
700022411	VHRJ 0890	40	346
700022412	VHRJ 0890	45	349
700022413	VHRJ 0890	50	351
700022414	VHRJ 0890	60	354
700022415	VHRJ 0890	76,2	364
700022416	VHRJ 0890	80	365
700022417	VHRJ 0890	90	371

61 depth / profundidad / profondeur

SAP	Code Código Code	Width Ancho Largeur	Points Puntos Points
700022402	VHRJ 0889	30	333
700022403	VHRJ 0889	40	338
700022404	VHRJ 0889	45	341
700022405	VHRJ 0889	50	343
700022406	VHRJ 0889	60	346
700022407	VHRJ 0889	76,2	360
700022408	VHRJ 0889	80	361
700022409	VHRJ 0889	90	364

Replacement
Repuestos
Pièces de rechange

Drawers and deep drawers
Cajones y extraíbles
Tiroirs et extractibles



Siphon-saver pull-out spare part with runners.
Height, 18,5 cm.

Recambio de extraíble salva-sifón con guías.
Alto, 18,5 cm.

Rechange extractible protège siphon, avec glissières.
Hauteur, 18,5 cm.

61 depth / profundidad / profondeur

SAP	Code Código Code	Width Ancho Largeur	Points Puntos Points
700022418	VHRJ 0891	60	344
700022419	VHRJ 0891	90	358
700022420	VHRJ 0891	120	369

Siphon-saver pull-out spare part with runners.
For PUSH system.
Height, 18,5 cm.

Recambio de extraíble salva-sifón con guías.
Para sistema PUSH.
Alto, 18,5 cm.

Rechange extractible protège siphon, avec glissières.
Pour système PUSH.
Hauteur, 18,5 cm.

61 depth / profundidad / profondeur

SAP	Code Código Code	Width Ancho Largeur	Points Puntos Points
700022421	VHRJ 0892	60	455
700022422	VHRJ 0892	90	474



Interior drawer' front.
Height, 13,5 cm.

Frente de cajón interior.
Alto, 13,5 cm.

Façade de tiroir intérieur.
Hauteur, 13,5 cm.

61 depth / profundidad / profondeur

SAP	Code Código Code	Width Ancho Largeur	Points Puntos Points
700022423	VHRJ 0893	30	43
700022424	VHRJ 0893	40	44
700022425	VHRJ 0893	45	44
700022426	VHRJ 0893	50	45
700022427	VHRJ 0893	60	46
700022428	VHRJ 0893	76,2	47
700022429	VHRJ 0893	80	48
700022430	VHRJ 0893	90	50
700022431	VHRJ 0893	100	51
700022432	VHRJ 0893	120	53

Interior deep-drawer' front.
Height, 24 cm.

Frente de gaveta interior.
Alto, 24 cm.

Façade de extractible intérieur.
Hauteur, 24 cm.

61 depth / profundidad / profondeur

SAP	Code Código Code	Width Ancho Largeur	Points Puntos Points
700022433	VHRJ 0894	30	45
700022434	VHRJ 0894	40	46
700022435	VHRJ 0894	45	47
700022436	VHRJ 0894	50	49
700022437	VHRJ 0894	60	51
700022438	VHRJ 0894	76,2	53
700022439	VHRJ 0894	80	54
700022440	VHRJ 0894	90	55
700022441	VHRJ 0894	100	57
700022442	VHRJ 0894	120	60

GAMADecor
PORCELANOSA Grupo



The mark of
responsible forestry
FSC® C115389



2017 · CATÁLOGO TÉCNICO NEW RESIDENCE · 09/17

© Copyright GAMA-DECOR, S.A. All rights reserved.

GAMADecor reserves the right to modify or cancel the information that appears in this catalogue concerning all aesthetic and technical aspects as well as pricing.

GAMADecor reserves the right to modify the characteristics of its products without prior notice.

The finishes shown are only for informative purposes; all rights are reserved due to the possible differences resulting from printing. For that reason, the photos displayed of the products are not to be deemed contractually binding.

All rights are reserved for possible errors within the texts which appear in the catalogue due to the composition or insertion of the pages.

This catalogue is informative only.

© Copyright GAMA-DECOR, S.A. Reservados todos los derechos.

GAMADecor se reserva el derecho de modificar, alterar, suprimir o añadir la información que aparece en este catálogo tanto a nivel estético, técnico como de valoración.

GAMADecor se reserva el derecho de modificar las características de sus productos sin preaviso de ningún tipo.

Los acabados se dan a título indicativo, quedando bajo reserva los ajustes de los colores consecuencia de las técnicas de impresión. Por ello, las fotos de los productos expuestos no son contractuales.

Los textos que aparecen en el catálogo quedan bajo reserva de posible error por composición o inserción en página.

Este catálogo es meramente informativo.

© Copyright GAMA-DECOR, S.A. Tous droits réservés.

GAMADecor se réserve le droit de modifier, d'ajouter ou de supprimer les informations qui apparaissent sur ce catalogue, tant au niveau esthétique, technique que de prix.

GAMADecor se réserve le droit de modifier les caractéristiques de ses produits sans aucun préavis.

Les finitions sont données à titre indicatif, ceci étant dû aux altérations de couleur provoquées par certaines techniques d'impression. Pour cela, les photographies des produits exposés ne sont pas contractuelles.

Les textes du catalogue sont sous réserve de possibles erreurs de compositions ou d'insertions de pages.

Ce catalogue a seulement un but informatif.



BY APPOINTMENT TO
H.R.H. THE PRINCE OF WALES
MANUFACTURER AND DISTRIBUTOR
OF CERAMIC TILES AND BUILDING PRODUCTS.
PORCELANOSA GROUP LIMITED

PORCELANOSA Grupo

residence®
kitchen technical catalogue 2017

GAMA-DECOR, S.A. Ctra. Vila-real - Puebla de Arenoso (CV-20) Km. 1,7.
12540 Vila-real, Castellón, España. Apdo. Correos 179.
Teléfono (+34) 964 506 850 Fax nacional: (+34) 964 506 596 Fax exportación: (+34) 964 506 597
e-mail: gama-decor@gama-decor.com · www.gama-decor.com