

TONO



Foster + Partners PORCELANOSA

TONO

TONO series by Foster + Partners and Porcelanosa Group brings together the products of three Porcelanosa companies: L'Antic Colonial, SystemPool and Noken. It is a very wide collection with many variations in finishes, depending on the work made by each company.

In the following catalogue only the pieces belonging to Noken are shown, so it should not be taken as the catalogue of the complete collection.

La serie TONO de Foster + Partners y Porcelanosa Grupo aúna los productos de tres empresas de Porcelanosa: L'Antic Colonial, SystemPool y Noken. Se trata de una colección muy amplia y con muchas variaciones en acabados, dependiendo del trabajo de cada empresa.

En el siguiente catálogo se muestran solamente las piezas que pertenecen a Noken, por lo que no se debe tomar como un catálogo de la colección completa.

Norman Foster, founder of Foster + Partners, is responsible for a strikingly wide range of work, from urban masterplans, public infrastructure, airports, civic and cultural buildings, offices and workplaces to private houses and furniture design. He was awarded Royal Gold Medal for Architecture in 1983, the Gold Medal for the French Academy of Architecture in 1991 and the American Institute of Architects Gold Medal in 1994. Also in 1994, he was appointed Officer of the Order of Arts and Letters by the Ministry of Culture in France. In 1999 he became the twenty-first Pritzker Architecture Prize Laureate. In 2009 he was awarded with the Prince of Asturias Arts Award.

Norman Foster, fundador de Foster + Partners, es responsable de una asombrosa variedad de trabajos, desde planos urbanísticos, infraestructuras públicas, aeropuertos, edificios cívicos y culturales, oficinas y lugares de trabajo hasta casas privadas y diseño de muebles. Recibió la Royal Gold Medal de arquitectura en 1983, la Gran Medalla de Oro de la Academia Francesa de Arquitectura en 1991 y la Medalla de Oro del Instituto Americano de Arquitectos en 1994. También en 1994 fue nombrado Oficial de la Orden de las Artes y las Letras por el Ministerio de Cultura de Francia. En 1999 se convirtió en el vigésimo primer galardonado con el Premio Pritzker. En 2009 fue galardonado con el Premio Príncipe de Asturias de las Artes.



"Architecture is the expression of values"



Millau Viaduc



30 St Mary Axe



Hearst Tower



Beijing Airport



The challenge was to create a set of components that work together as part of an integrated system, with an unlimited choice of finishes and materials. Unified by a common, simple design language and palette of complementary materials and colour tones, the minimalist aesthetic brings to the fore an honesty of material, simplicity of form and the craft of manufacture.

El verdadero desafío fue crear un conjunto de componentes que funcionaran juntos como parte de un sistema integrado, con una selección ilimitada de acabados y materiales. Unificada por un lenguaje de diseño común y simple y una paleta de materiales complementarios y tonos de color, la estética minimalista pone de relieve la honestidad del material, la simplicidad de la forma y el arte de la fabricación.

Mike Holland - Head of Industrial Design at Foster + Partners
Mike Holland - Director de Diseño Industrial en Foster + Partners

TONO

Foster + Partners PORCELANOSA



NO MORE, NO LESS

Ni más ni menos

No other organisation has a palette as wide as **Porcelanosa**. Marble, ceramics, Krion, timber, brassware... Its breadth of materials and techniques now combines with the vision of **Foster + Partners** in the perfect marriage. **TONO** offers architects and designers a new departure in bathroom design.

No more, no less. Just as eliminating superfluous detail makes for better design, it also enhances sustainability.

Two companies, one philosophy, infinite possibilities.

*Ninguna otra organización tiene una oferta tan amplia como **Porcelanosa**. Mármol, cerámica, Krion, madera, grifería... Su cantidad de materiales y técnicas ahora combina con la visión de **Foster + Partners** en el maridaje perfecto. **TONO** ofrece a arquitectos y diseñadores un nuevo punto de partida en el diseño del cuarto de baño.*

Ni más ni menos. Simplemente eliminando los detalles superfluos se crea un mejor diseño que también favorece la sostenibilidad.

Dos compañías, una filosofía, infinitas posibilidades.

TONO asks the important question first. What's the most efficient volume of water? How can controls be made genuinely intuitive? Aesthetics derive from functionality and the innate properties of the materials used.

The result of physical making rather than theoretical ideas, the performance of each TONO product has been optimised through rigorous testing, prototyping and human interaction.

Together, Foster + Partners and Porcelanosa Bathrooms pushed themselves to develop something out of the ordinary: individually crafted components that simultaneously work holistically and harmoniously.

TONO is defined by its extensive choice and the flexibility it offers. Almost any configuration is possible, the material combinations emphasising the strength of each element while underlining the homogeneity of the range.

TONO hace primero la pregunta importante. ¿Cuál es el volumen de agua más eficiente? ¿Cómo pueden hacerse los controles genuinamente intuitivos? La estética deriva de la funcionalidad y las propiedades innatas del material utilizado.

El resultado de la creación física en lugar de ideas teóricas, el rendimiento de cada producto TONO se ha optimizado a través de pruebas rigurosas, creación de prototipos e interacción humana.

Juntos, Foster + Partners y Porcelanosa Bathrooms se han esforzado por desarrollar algo fuera de lo común: componentes elaborados de forma individual funcionan simultáneamente de manera holística y armoniosa.

TONO se define por sus opciones y la flexibilidad que ofrece. Casi cualquier configuración es posible, las combinaciones de materiales enfatizan la resistencia de cada elemento mientras se subraya la homogeneidad de la serie.

Bathrooms can be adapted according to taste and context in the knowledge that everything works together.

Los baños se pueden adaptar según el gusto y el contexto teniendo en mente que todo funciona como un conjunto.



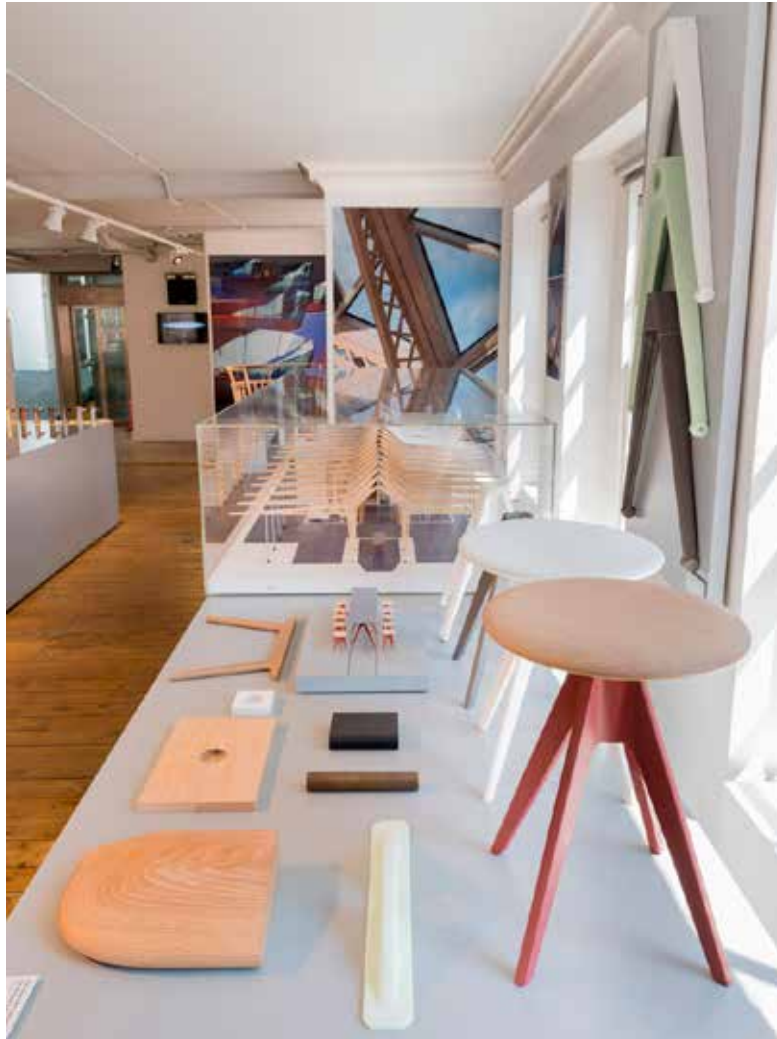

Foster + Partners Exhibition at Aram Gallery

The Industrial Design team of Foster + Partners carries out a diverse range of work, frequently working as an integral part of the overall studio, designing specific building elements, but also developing products at the commercial and domestic scale in collaboration with industry partners such as Porcelanosa Group with TONO collection.

El equipo de Diseño Industrial de Foster + Partners lleva a cabo una amplia gama de labores, trabajando frecuentemente como parte integral del estudio general, diseñando elementos de construcción específicos, pero también desarrollando productos a escala comercial y doméstica, en colaboración con socios industriales, como por ejemplo Porcelanosa Grupo con la colección TONO.



noken







The wall hung sanitary elements of the collection, manufactured in Noken Ceramic® -Noken's high quality sanitary ceramics, add contemporary minimalism to the bathroom, subtracting everything superfluous to obtain highly dynamic pieces.

In addition, TONO toilet contributes to sustainability with a double reduced water flush of 3 and 4,5 litres.

Los elementos sanitarios suspendidos de la colección, manufacturados en Noken Ceramic®, la cerámica sanitaria de alta calidad de Noken, aportan al baño minimalismo contemporáneo, restando todo lo superfluo para obtener piezas altamente dinámicas.

Además, el inodoro TONO contribuye a la sostenibilidad con una doble descarga de agua reducida de 3 y 4,5 litros.

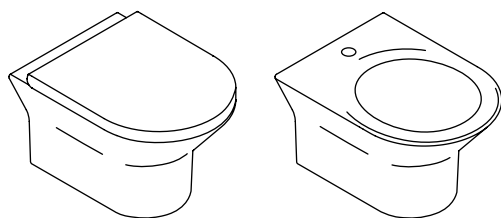

With proportions and solidity that belie their light, intuitive feel, taps feature a bevel that catches the light and acts as a visual cue to lift the control lever, together with a rib surface that invites them to be turned.

Con proporciones y una solidez que desmienten su apariencia intuitiva y ligera, las piezas de grifería de lavabo cuentan con un bisel que atrapa la luz y actúa como una señal visual para levantar la maneta, junto con una superficie estriada que invita a ser utilizada.

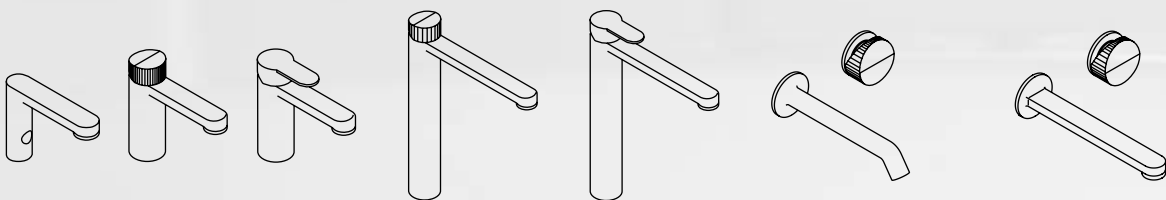



noken



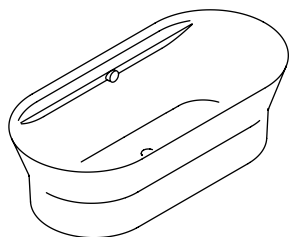

The freestanding bath has an integrated shelf, and so that nothing disrupts the purity of its form, all pipes and overflow are hidden away.

La bañera exenta tiene una superficie de apoyo integrada, y para que nada interrumpa la pureza de su forma, todas las tuberías y el rebosadero están ocultos.





Wash basins are countertop or wall-mounted, their blend off functionality and minimalism exemplified by a concealed click-clack plug mechanism. Also, the overflow allows the use of these basins for high transit areas.

Made in Noken Ceramic®, TONO washbasins not only provide high resistance and functionality, but also respect the essence of the TONO series.

Los lavabos pueden ser de encimera o suspendidos, y su combinación de funcionalidad y minimalismo se ejemplifica por un vaciador clicker cerámico. Además, el rebosadero permite el uso de estos lavabos en zonas de alto tránsito.

Hechos en Noken Ceramic®, los lavabos TONO no solamente aportan resistencia y funcionalidad sino que también respetan la esencia de la serie TONO.

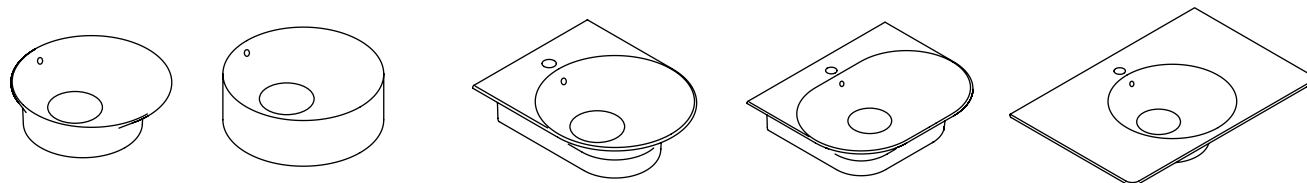





Simplicity and proven functionality are the keys to the success of TONO shower heads. Designed to adapt to any space in the bathroom, this 40 cm diameter pieces make showering a daily pleasure.

On top of that, the hand shower (both for the thermostatic set and the floor mounted brassware) is held with a magnetic support, which makes the hole composition a bit different.

Sencillez y funcionalidad son las claves de los rociadores TONO. Pensados para adaptarse a cualquier espacio del cuarto de baño, estas piezas de 40 centímetros de diámetro hacen de la ducha un placer diario.

Además, la teleducha (tanto en la termostática como en la instalación a pavimento) se sujeta a través de un soporte magnético que aporta al conjunto un toque diferente.

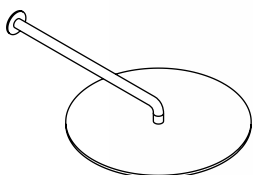

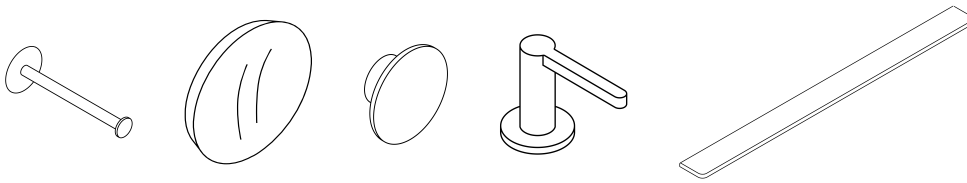

The list of bathroom accessories is almost endless and includes towel rails, hangers, cabinets and countless small yet carefully designed elements that mark the difference between each bathroom while also increasing the practical nature of this space.

La lista de accesorios de baño es casi infinita con toalleros, colgadores, portaobjetos y un sinfín de pequeños elementos con un cuidado diseño que imprimen el carácter diferenciador a cada cuarto de baño al tiempo que elevan el sentido práctico de este espacio.













TONO brassware and accessories are available in chrome finish. For the rest of finishes (gold, copper, titanium, both gloss and satin versions, and satin chrome) is necessary to establish contact with Noken commercial department.

Las piezas de grifería y accesorios de TONO están disponibles en cromo. Para el resto de acabados disponibles (oro, titanio, bronce, sus versiones satinadas y el cromo satinado) es necesario consultar con el equipo comercial de Noken.

Specifications

Especificaciones

Noken TONO Elements: Washbasins
Noken Elementos TONO: Lavabos

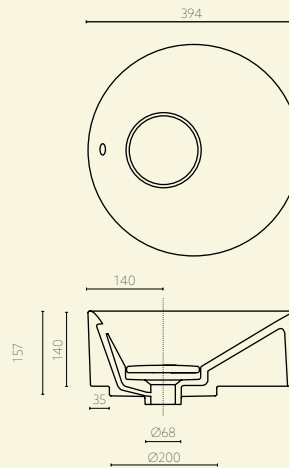
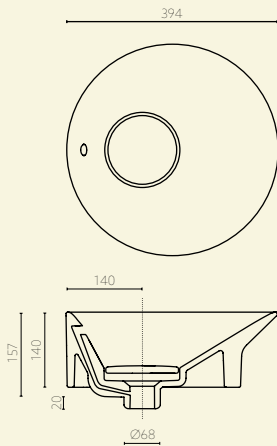
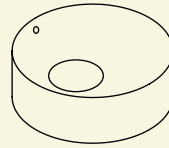
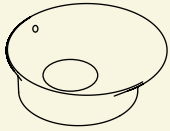

Ceramic Basin Countertop 400 Angled
Lavabo cerámico angular de apoyo 400

- Features:
- Clicker waste with ceramic cover
 - Overflow CL 20
 - Compact Ceramic Technology
 - Chemical Resistant
 - Easy-clean surface

- Características:
- Vaciador - clicker con cubierta cerámica
 - Rebosadero CL 20
 - Tecnología de cerámica compacta
 - Resistencia a químicos
 - Superficie de fácil limpieza

Ceramic Basin Countertop 400 Cylindrical
Lavabo cerámico cilíndrico de apoyo 400

- Features:
- Clicker waste with ceramic cover
 - Overflow CL 20
 - Compact Ceramic Technology
 - Chemical Resistant
 - Easy-clean surface

- Características:
- Vaciador - clicker con cubierta cerámica
 - Rebosadero CL 20
 - Tecnología de cerámica compacta
 - Resistencia a químicos
 - Superficie de fácil limpieza

Finishes
Acabados



Finishes
Acabados



Noken TONO Elements: Washbasins
Noken Elementos TONO: Lavabos

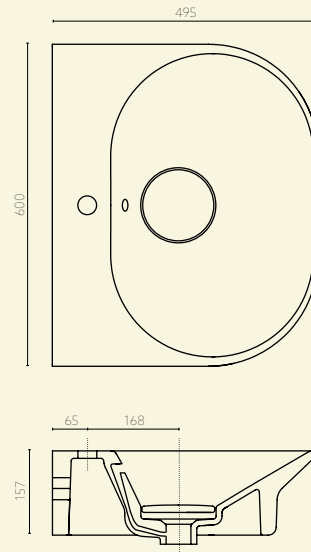
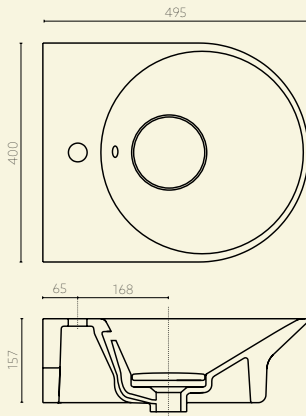
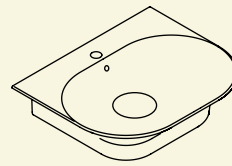
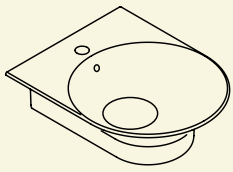

Ceramic Basin Wall Mounted 400
Lavabo cerámico suspendido 400

- Features:
 Clicker waste with ceramic cover
 Overflow CL 25
 Compact Ceramic Technology
 Chemical Resistant
 Easy-clean surface

- Características:*
 Vaciador - clicker con cubierta cerámica
 Rebosadero CL 25
 Tecnología de cerámica compacta
 Resistencia a químicos
 Superficie de fácil limpieza

Ceramic Basin Wall Mounted 600
Lavabo cerámico suspendido 600

- Features:
 Clicker waste with ceramic cover
 Overflow CL 25
 Compact Ceramic Technology
 Chemical Resistant
 Easy-clean surface

- Características:*
 Vaciador - clicker con cubierta cerámica
 Rebosadero CL 25
 Tecnología de cerámica compacta
 Resistencia a químicos
 Superficie de fácil limpieza

Finishes
Acabados



Finishes
Acabados



Noken TONO Elements: Washbasins
Noken Elementos TONO: Lavabos

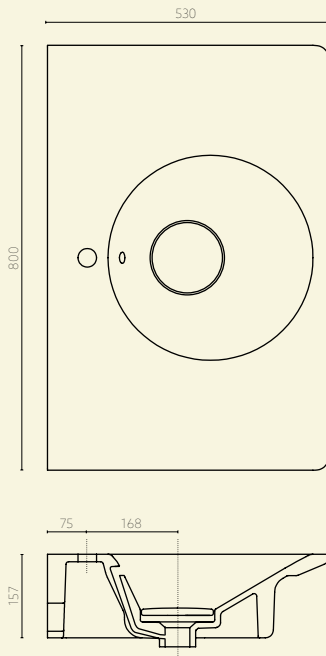
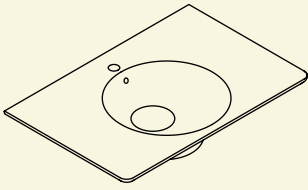

Ceramic Basin Wall Mounted 800
Lavabo cerámico suspendido 800

Features:

- Clicker waste with ceramic cover
- Overflow CL 20
- Compact Ceramic Technology
- Chemical Resistant
- Easy-clean surface

Características:

- Vaciador - clicker con cubierta cerámica
- Rebosadero CL 20
- Tecnología de cerámica compacta
- Resistencia a químicos
- Superficie de fácil limpieza

Finishes
Acabados



Noken Ceramic®

Noken TONO Elements: Sanitaryware
Noken Elementos TONO: Sanitario

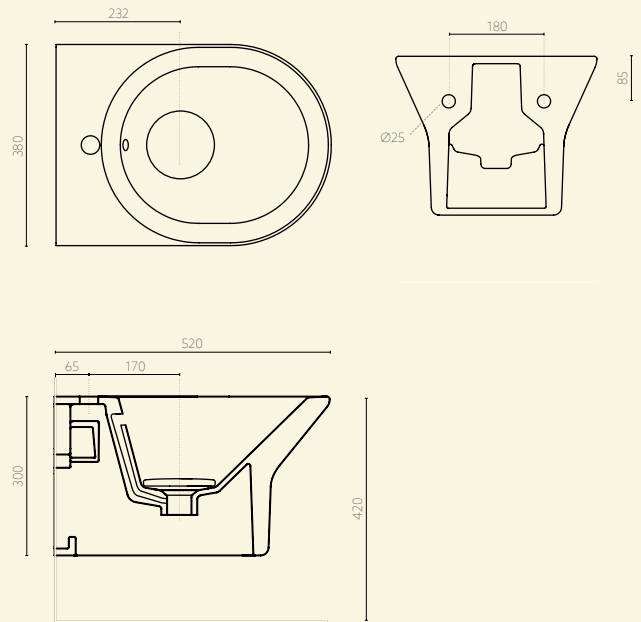
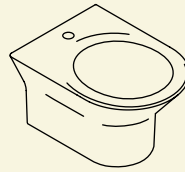

Wall hung bidet
Bidé suspendido

Features:

- Clicker waste with ceramic cover included
- Fixing kit included
- Overflow CL 20
- Compact Ceramic Technology
- Chemical Resistant
- Easy-clean surface

Características:

- Vaciador - clicker con cubierta cerámica
- Incluye las fijaciones
- Rebosadero CL 20
- Tecnología de cerámica compacta
- Resistencia a químicos
- Superficie de fácil limpieza

Finishes
Acabados



Noken Ceramic®

Noken TONO Elements: Sanitaryware
Noken Elementos TONO: Sanitario

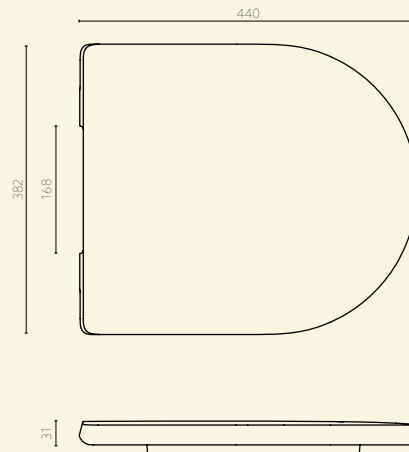
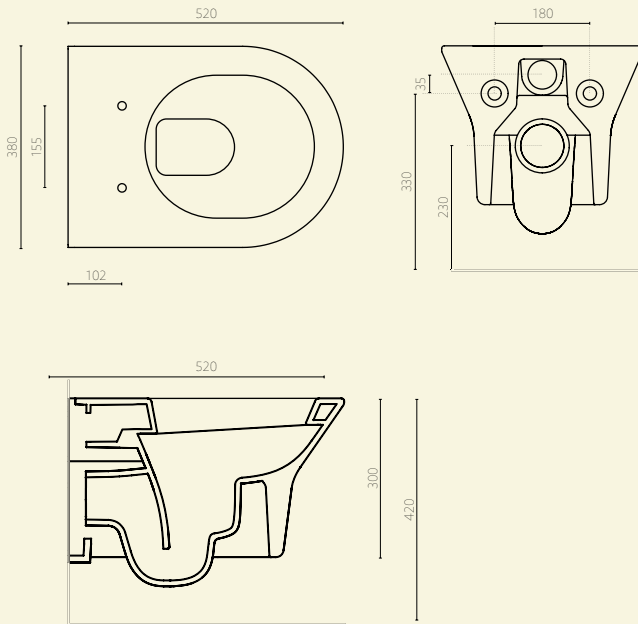
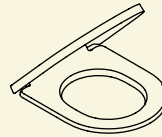
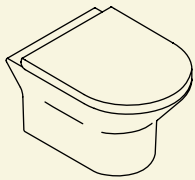

Wall hung pan

Inodoro suspendido

Features:

Compatible with 3-4,5 litre/flush cisterns

Fixing kit included

Compact Ceramic Technology

Chemical Resistant

Easy-clean surface

Características:

Compatible con cisternas de 3-4,5 litros/descarga

Incluye las fijaciones

Tecnología de cerámica compacta

Resistencia a químicos

Superficie de fácil limpieza

Toilet seat and cover

Asiento de inodoro

Features:

Soft close hinges with 10 year warranty

Extra slim comfort design

Produced in Thermotur®

Características:

Bisagra amortiguada con 10 años de garantía

Diseño comfort extra fino

Realizado en Thermotur®

Finishes

Acabados



Noken Ceramic®



Thermotur®

Noken TONO Elements: Brassware
Noken Elementos TONO: Grifería

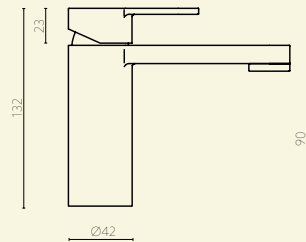
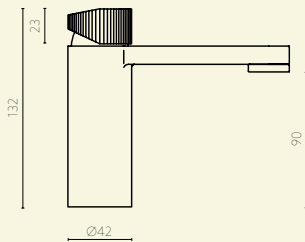
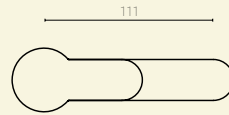
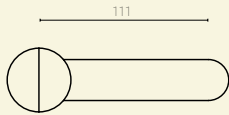
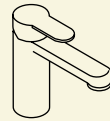
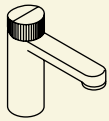

Basin mixer with rib handle

Monomando lavabo con maneta estriada

Features:

Ø25 mm Ceramic cartridge

Flow rate: 5.68 l/min at 3 bar

Flexi hose 3 / 8" connection, length 500mm

Características:

Cartucho cerámico de Ø25 mm

Caudal: 5,68 l/min a 3 bares

Latiguillos con conexión 3/8" y longitud de 500mm

Single lever basin mixer

Monomando lavabo

Features:

Ø25 mm Ceramic cartridge

Flow rate: 5.68 l/min at 3 bar

Flexi hose 3 / 8" connection, length 500mm

Características:

Cartucho cerámico de Ø25 mm

Caudal: 5,68 l/min a 3 bares

Latiguillos con conexión 3/8" y longitud de 500mm

Finishes
Acabados

* Subject to consultation
* Sujeto a consulta



Chrome
Cromo



Satin chrome*
*Cromo satinado**



Titanium*
*Titanio**



Satin titanium*
*Titanio satinado**



Gold*
*Oro**



Satin gold*
*Oro satinado**



Copper*
*Cobre**



Satin copper*
*Cobre satinado**

Finishes
Acabados

* Subject to consultation
* Sujeto a consulta



Chrome
Cromo



Satin chrome*
*Cromo satinado**



Titanium*
*Titanio**



Satin titanium*
*Titanio satinado**



Gold*
*Oro**



Satin gold*
*Oro satinado**



Copper*
*Cobre**



Satin copper*
*Cobre satinado**

Noken TONO Elements: Brassware
Noken Elementos TONO: Grifería

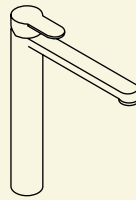
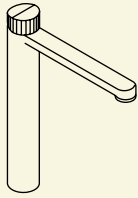

190

190

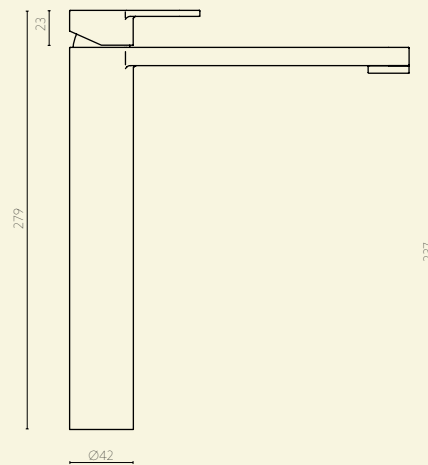
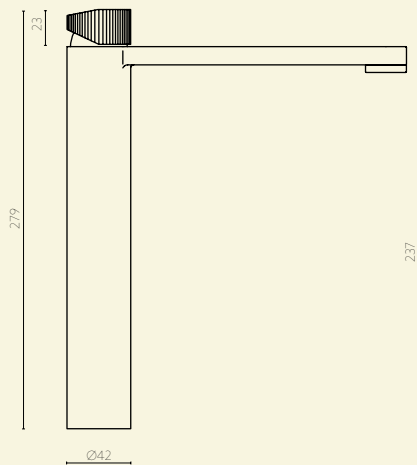
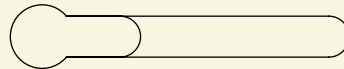
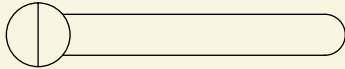

High spout basin mixer with rib handle
Monomando lavabo c/alto y maneta estriada

Features:
 Ø25 mm Ceramic cartridge
 Flow rate: 5.68 l/min at 3 bar
 Flexi hose 3 / 8" connection, length 500mm

Características:
 Cartucho cerámico de Ø25 mm
 Caudal: 5,68 l/min a 3 bares
 Latiguillos con conexión 3/8" y longitud de 500mm

High spout basin mixer
Monomando lavabo c/alto

Features:
 Ø25 mm Ceramic cartridge
 Flow rate: 5.68 l/min at 3 bar
 Flexi hose 3 / 8" connection, length 500mm

Características:
 Cartucho cerámico de Ø25 mm
 Caudal: 5,68 l/min a 3 bares
 Latiguillos con conexión 3/8" y longitud de 500mm

Finishes
Acabados

* Subject to consultation
 * Sujeto a consulta

 Chrome Cromo	 Satin chrome* Cromo satinado*
 Titanium* Titanio*	 Satin titanium* Titanio satinado*
 Gold* Oro*	 Satin gold* Oro satinado*
 Copper* Cobre*	 Satin copper* Cobre satinado*

Finishes
Acabados

* Subject to consultation
 * Sujeto a consulta

 Chrome Cromo	 Satin chrome* Cromo satinado*
 Titanium* Titanio*	 Satin titanium* Titanio satinado*
 Gold* Oro*	 Satin gold* Oro satinado*
 Copper* Cobre*	 Satin copper* Cobre satinado*

Noken TONO Elements: Brassware
Noken Elementos TONO: Grifería

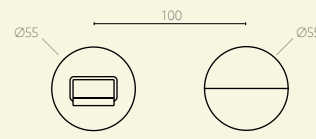
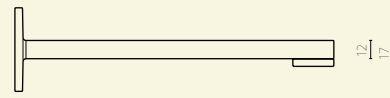
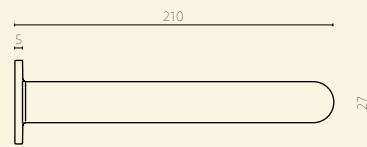
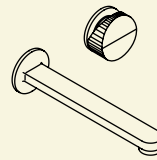
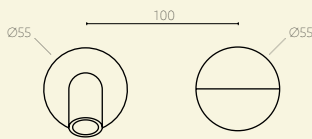
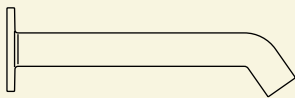
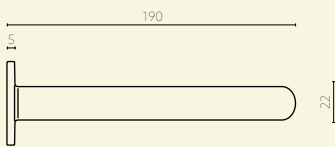
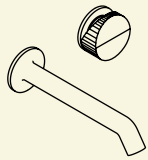

Wall Mounted Mixer With Round Spout

Monomando lavabo encastre a pared con caño redondo

Features:

Ø35 mm Ceramic cartridge
 Flow rate: 5.68 l/min at 3 bar

Características:

*Cartucho cerámico de Ø35 mm
 Caudal: 5,68 l/min a 3 bares*

Wall Mounted Mixer With Flat Spout

Monomando lavabo encastre a pared con caño cuadrado

Features:

Ø35 mm Ceramic cartridge
 Flow rate: 5.68 l/min at 3 bar

Características:

*Cartucho cerámico de Ø35 mm
 Caudal: 5,68 l/min a 3 bares*

Finishes
Acabados

* Subject to consultation
 * Sujeto a consulta

 Chrome <i>Cromo</i>	 Satin chrome* <i>Cromo satinado*</i>
 Titanium* <i>Titanio*</i>	 Satin titanium* <i>Titanio satinado*</i>
 Gold* <i>Oro*</i>	 Satin gold* <i>Oro satinado*</i>
 Copper* <i>Cobre*</i>	 Satin copper* <i>Cobre satinado*</i>

Finishes
Acabados

* Subject to consultation
 * Sujeto a consulta

 Chrome <i>Cromo</i>	 Satin chrome* <i>Cromo satinado*</i>
 Titanium* <i>Titanio*</i>	 Satin titanium* <i>Titanio satinado*</i>
 Gold* <i>Oro*</i>	 Satin gold* <i>Oro satinado*</i>
 Copper* <i>Cobre*</i>	 Satin copper* <i>Cobre satinado*</i>

Noken TONO Elements: Brassware
Noken Elementos TONO: Grifería

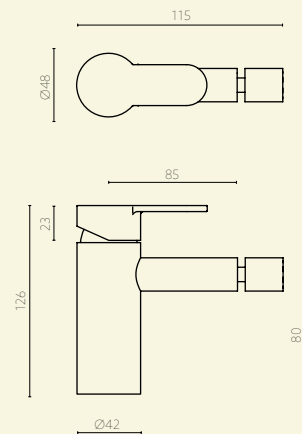
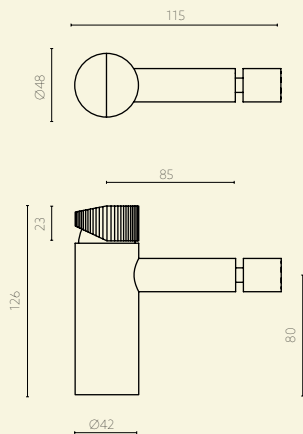
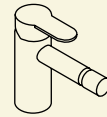
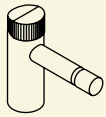

Bidet mixer with rib handle

Monomando bidé con maneta estriada

Features:

Ø35 mm Ceramic cartridge

Flow rate: 5.68 l/min at 3 bar

Flexi hose 3 / 8" connection, length 400mm

Características:

Cartucho cerámico de Ø35 mm

Caudal: 5,68 l/min a 3 bares

Latiguillos con conexión 3/8" y longitud de 400mm

Single lever bidet mixer

Monomando bidé

Features:

Ø35 mm Ceramic cartridge

Flow rate: 5.68 l/min at 3 bar

Flexi hose 3 / 8" connection, length 400mm

Características:



Cartucho cerámico de Ø35 mm

Caudal: 5,68 l/min a 3 bares

Latiguillos con conexión 3/8" y longitud de 400mm







Finishes
Acabados

* Subject to consultation
* Sujeto a consulta

 Chrome <i>Cromo</i>	 Satin chrome* <i>Cromo satinado*</i>
 Titanium* <i>Titanio*</i>	 Satin titanium* <i>Titanio satinado*</i>
 Gold* <i>Oro*</i>	 Satin gold* <i>Oro satinado*</i>
 Copper* <i>Cobre*</i>	 Satin copper* <i>Cobre satinado*</i>

Finishes
Acabados

* Subject to consultation
* Sujeto a consulta

 Chrome <i>Cromo</i>	 Satin chrome* <i>Cromo satinado*</i>
 Titanium* <i>Titanio*</i>	 Satin titanium* <i>Titanio satinado*</i>
 Gold* <i>Oro*</i>	 Satin gold* <i>Oro satinado*</i>
 Copper* <i>Cobre*</i>	 Satin copper* <i>Cobre satinado*</i>

Noken TONO Elements: Brassware
Noken Elementos TONO: Grifería

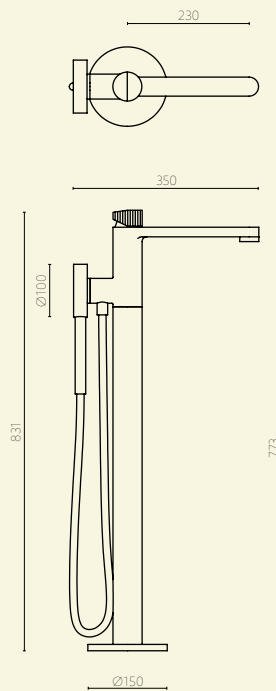
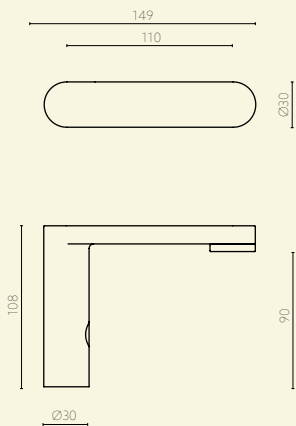
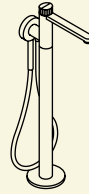
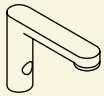

Sensor tap
Grifería de lavabo electrónica

Features:
 Sensor operated
 Flow rate: 5.68 l/min at 3 bar
 6V battery connection

Características:
 Funcionamiento con sensor
 Caudal: 5,68 l/min a 3 bares
 Batería de 6V

Floor mounted single lever bath mixer
Monomando baño ducha instalación a pavimento

Features:
 Ø40 mm Ceramic cartridge
 Includes handshower with magnetic support
 Flow rate: 19 l/min (spout) and 6,8 l/min (handshower) at 3 bar

Características:
 Cartucho cerámico de Ø40mm
 Incluye teleducha con soporte magnético
 Caudal: 19 l/min (caño) y 6,8 l/min (teleducha) a 3 bares









Finishes
Acabados

* Subject to consultation
 * Sujeto a consulta

 Chrome <i>Cromo</i>	 Satin chrome* <i>Cromo satinado*</i>
 Titanium* <i>Titanio*</i>	 Satin titanium* <i>Titanio satinado*</i>
 Gold* <i>Oro*</i>	 Satin gold* <i>Oro satinado*</i>
 Copper* <i>Cobre*</i>	 Satin copper* <i>Cobre satinado*</i>

Finishes
Acabados

* Subject to consultation
 * Sujeto a consulta

 Chrome <i>Cromo</i>	 Satin chrome* <i>Cromo satinado*</i>
 Titanium* <i>Titanio*</i>	 Satin titanium* <i>Titanio satinado*</i>
 Gold* <i>Oro*</i>	 Satin gold* <i>Oro satinado*</i>
 Copper* <i>Cobre*</i>	 Satin copper* <i>Cobre satinado*</i>

Noken TONO Elements: Brassware
Noken Elementos TONO: Grifería

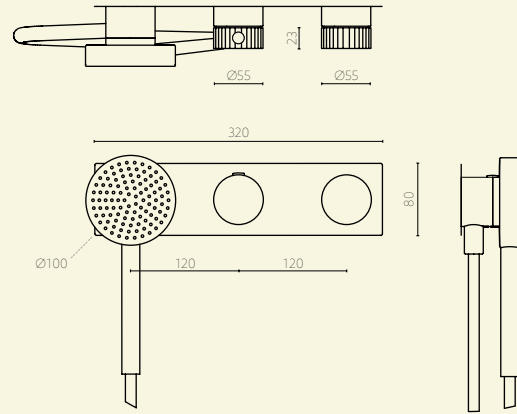
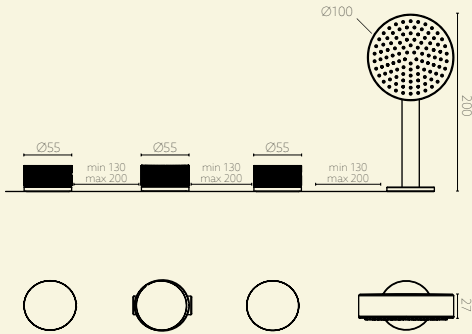
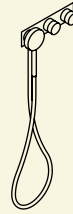
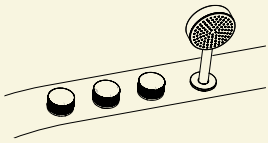

4 hole deck mounted bath set
Kit instalación repisa bañera

Includes:
 Bath valves
 Diverter
 Handshower and holder

Incluye:
 Llaves de paso de agua fría/caliente
 Inversor
 Soporte con teleducha







Thermostatic shower set
Parte externa termostática

Includes:
 Flexi hose
 Handshower
 Magnetic support

Incluye:
 Flexible
 Teleducha
 Soporte magnético









Finishes
Acabados

* Subject to consultation
 * Sujeto a consulta

 Chrome Cromo	 Satin chrome* Cromo satinado*
 Titanium* Titanio*	 Satin titanium* Titanio satinado*
 Gold* Oro*	 Satin gold* Oro satinado*
 Copper* Cobre*	 Satin copper* Cobre satinado*

Finishes
Acabados

* Subject to consultation
 * Sujeto a consulta

 Chrome Cromo	 Satin chrome* Cromo satinado*
 Titanium* Titanio*	 Satin titanium* Titanio satinado*
 Gold* Oro*	 Satin gold* Oro satinado*
 Copper* Cobre*	 Satin copper* Cobre satinado*

Noken TONO Elements: Brassware
Noken Elementos TONO: Grifería

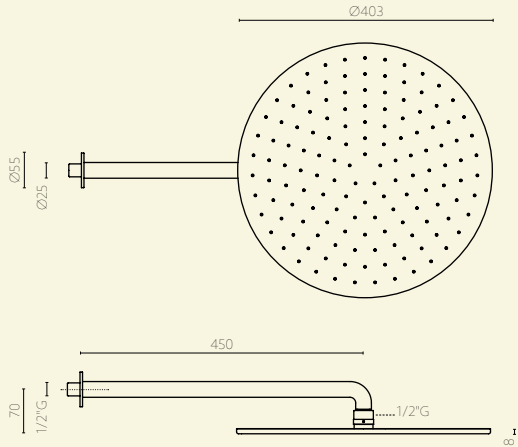
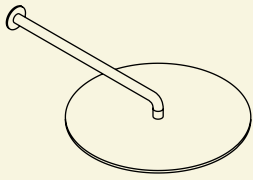

Noken TONO Elements: Bath tub
Noken Elementos TONO: Bañera

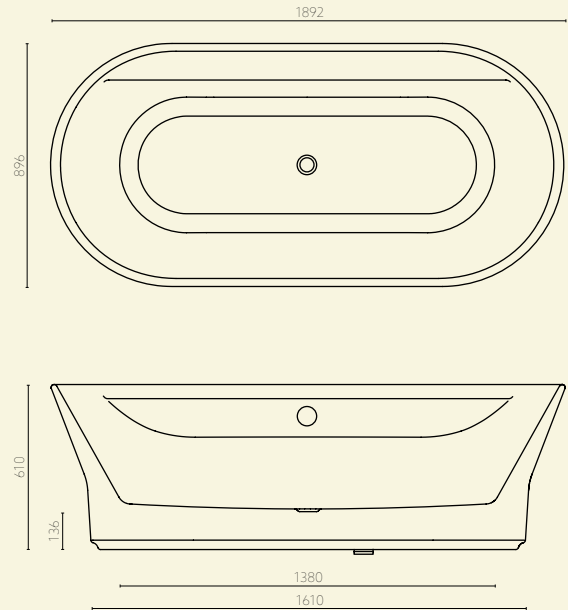
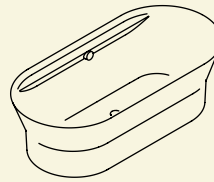









Shower head
Rociador

Features:
 400mm diameter
 Flow rate: 18 l/min at 3 bar
 450mm wall installation arm included

Características:
 Diámetro de 400mm
 Caudal: 18 l/min a 3 bares
 Brazo de instalación a pared de 450mm incluido

Finishes
Acabados

* Subject to consultation
 * Sujeto a consulta

	Chrome <i>Cromo</i>		Satin chrome* <i>Cromo satinado*</i>
	Titanium* <i>Titanio*</i>		Satin titanium* <i>Titanio satinado*</i>
	Gold* <i>Oro*</i>		Satin gold* <i>Oro satinado*</i>
	Copper* <i>Cobre*</i>		Satin copper* <i>Cobre satinado*</i>

Acrylic Freestanding Bathtub
Bañera Exenta Acrílica

Features:
 Without brassware
 One-piece
 Centre bath waste
 Includes automatic drain

Características:
 Sin grifería
 Monocasco
 Desagüe central
 Incluye desagüe automático

Finishes
Acabados

	Lucite Acrylic <i>Acrílico Lucite</i>
---	--

Noken TONO Elements: Accessories
Noken Elementos TONO: Accesorios

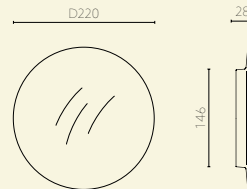
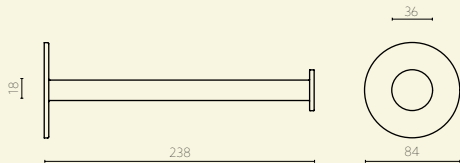
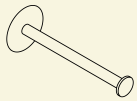

Roll holder
Portapapel sin tapa

Related items:
 Wall mounted toilet

Elementos relacionados:
Inodoro suspendido

Magnifying mirror
Espejo de aumento

Features:
 3x zoom
 Magnetic backing

Características:
3x zoom
Parte trasera magnética









Finishes
Acabados

* Subject to consultation
 * Sujeto a consulta

 Chrome <i>Cromo</i>	 Satin chrome* <i>Cromo satinado*</i>
 Titanium* <i>Titanio*</i>	 Satin titanium* <i>Titanio satinado*</i>
 Gold* <i>Oro*</i>	 Satin gold* <i>Oro satinado*</i>
 Copper* <i>Cobre*</i>	 Satin copper* <i>Cobre satinado*</i>

Finishes
Acabados

* Subject to consultation
 * Sujeto a consulta

 Chrome <i>Cromo</i>	 Satin chrome* <i>Cromo satinado*</i>
 Titanium* <i>Titanio*</i>	 Satin titanium* <i>Titanio satinado*</i>
 Gold* <i>Oro*</i>	 Satin gold* <i>Oro satinado*</i>
 Copper* <i>Cobre*</i>	 Satin copper* <i>Cobre satinado*</i>

Noken TONO Elements: Accessories
Noken Elementos TONO: Accesorios

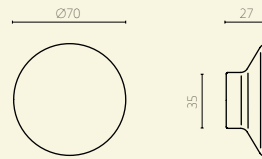
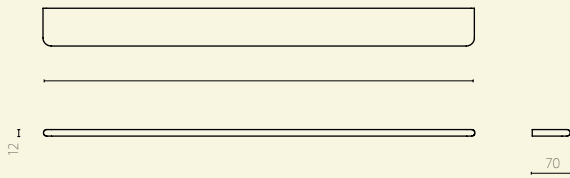
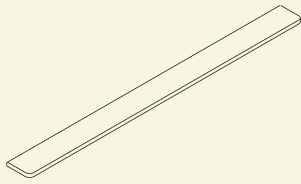

Shower shelf

Balda para ducha

Features:
 Concealed fixings
 Ni-Cr coating

Características:
Fijaciones para colgar
Recubrimiento de níquel y cromo

Robe hook

Colgador

Features:
 Concealed fixings
 Ni-Cr coating

Características:
Fijaciones para colgar
Recubrimiento de níquel y cromo







Finishes
Acabados

* Subject to consultation
** Sujeto a consulta*

 Chrome <i>Cromo</i>	 Satin chrome* <i>Cromo satinado*</i>
 Titanium* <i>Titanio*</i>	 Satin titanium* <i>Titanio satinado*</i>
 Gold* <i>Oro*</i>	 Satin gold* <i>Oro satinado*</i>
 Copper* <i>Cobre*</i>	 Satin copper* <i>Cobre satinado*</i>

Finishes
Acabados

* Subject to consultation
** Sujeto a consulta*

 Chrome <i>Cromo</i>	 Satin chrome* <i>Cromo satinado*</i>
 Titanium* <i>Titanio*</i>	 Satin titanium* <i>Titanio satinado*</i>
 Gold* <i>Oro*</i>	 Satin gold* <i>Oro satinado*</i>
 Copper* <i>Cobre*</i>	 Satin copper* <i>Cobre satinado*</i>

Noken TONO Elements: Accessories
Noken Elementos TONO: Accesorios

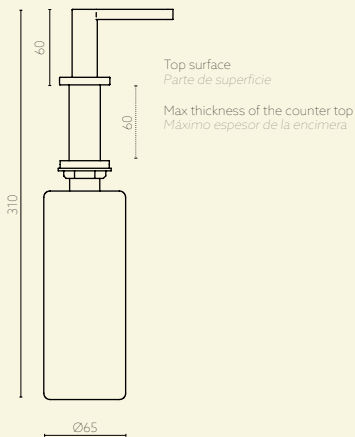
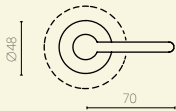
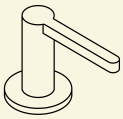

Soap dispenser
Dosificador de jabón

Features:
 Countertop installation
 Anti-theft system
 Ni-Cr coating

Características:
 Instalación de encastre encimera
 Sistema antirrobo
 Recubrimiento de níquel y cromo

Finishes
Acabados

* Subject to consultation
 * Sujeto a consulta



Chrome
Cromo



Satin chrome*
*Cromo satinado**



Titanium*
*Titanio**



Satin titanium*
*Titanio satinado**



Gold*
*Oro**



Satin gold*
*Oro satinado**



Copper*
*Cobre**



Satin copper*
*Cobre satinado**

PORCELANOSA Grupo



www.noken.com



NOKEN DESIGN, S.A.

Carretera CV-20 Km. 2 · 12540 Vila-real · Castellón · Spain
Tel: +34 964 50 64 50 - Fax: +34 964 50 67 93
e-mail: noken@noken.com

Edition data · *Fecha edición:* January *Enero* 2018

Design · *Diseño:* Dpto. Publicidad Noken

Photography · *Fotografía:* Dpto. Publicidad Noken

Printed by · *Imprime:* Ingoprint, S.A.

Edition · *Edita:* NOKEN DESIGN S.A.

Project photography · *Fotografía de proyectos:* Nigel Young, Foster + Partners



NOKEN DESIGN, S.A.

The contents of this catalogue are protected by virtue of the Spanish Intellectual Property Act, Royal Legislative Decree 1/1996. The partial or total reproduction of this catalogue, without the express authorisation of NOKEN DESIGN is punishable under the Spanish Criminal Code.

El contenido de este catálogo está protegido por la Ley de Propiedad Intelectual, Real Decreto Legislativo 1/1996.

Cualquier reproducción del mismo, en parte o en su totalidad, sin autorización expresa de Noken Design, S.A. puede ser sancionada conforme el Código Penal.

NOKEN DESIGN, S.A.

Reserves the right to cancel and/or change models or accessories without prior notice or replacement. The settings shown in this catalogue are design proposals for advertising purposes. In real situations in which the tiles are laid, we recommend to use as a guide for the installation, the technical specifications available on the website of Noken.

Se reserva el derecho legal de anular y/o aportar posibles modificaciones a sus productos y accesorios sin previo aviso ni sustitución. Los ambientes que se muestran en este catálogo son sugerencias decorativas de carácter publicitario, debiéndose utilizar como guía para la instalación, las fichas técnicas que se encuentran en la página web de Noken.

noken
PORCELANOSA BATHROOMS